



**d**

**Dione<sup>®</sup>**





**TUOTEKUVASTO  
PRODUKTKATALOG  
PRODUCT CATALOGUE**

VOIMASSA | GÄLLER FRÅN | VALID FROM 1.6.2026

# Dione®

MADE BY DUURI

-  Duuri Oy on kansainvälinen perheyhtiö, joka toimii Pohjoismaissa ja Baltian maissa.
-  Duuri Oy är ett internationellt familjeföretag vars försäljningsområde täcker Norden och Baltikum.
-  Duuri Oy is a family enterprise operating in the Nordics and the Baltic countries.



## FINLAND

DUURI OY  
Tapulikaupungintie 35  
FI-00750 Helsinki, Finland

p. 09 351 050 (myynti ja  
tekninen neuvonta)  
duuri@duuri.fi

## DENMARK

D-PROFILE AB  
Kabelvägen 10B  
SE-55302 Jönköping, Sverige

Tel. +46 (0)36 – 18 63 63  
info@d-profile.se

## SWEDEN

D-PROFILE AB  
Kabelvägen 10B  
SE-55302 Jönköping, Sverige

Tel. +46 (0)36 – 18 63 63  
info@d-profile.se

## NORWAY

D-PROFILE AS  
Glåmveien 3  
NO-2500 Tynset, Norge

Tel. +46 (0)70 – 513 14 34  
info@d-profile.se

## LATVIA, LITHUANIA AND ESTONIA

SIA D-PROFILE  
Rigas iela 6  
LV-2114 Olaine, Latvia

Tel. +371 6778 3506  
Tel. +372 5058 880 (Estonia)  
info@d-profile.lv

[www.dione.fi](http://www.dione.fi)



## ASIAKASLÄHTÖISIÄ RATKAISUJA SISÄTILOJEN VIIMEISTELYYN

Tähän Dione-kuvastoon olemme koonneet keskusvarastomme tärkeimmät sisätilojen viimeistelytuotteet rakentamiseen ja remontointiin: tyylikkääät listat ja profilit, korkeatasoiset luukut sekä paljon muita tuotteita, joilla viimeistelet tiloja laadukkaasti ja kestävästi.

Varastostamme on nopeasti saatavilla noin 3500 nimikettä. Tutustu koko valikoimaan verkkosivuillamme [www.dione.fi](http://www.dione.fi), joilta löydät myös mm. törmäyssuojat, esteettömyys- ja kulunohjaustuotteet sekä lattiahiomakoneet.

Palvelemme lähes 50 vuoden kokemuksella jälleenmyyjiä, rakentamisen ammattilaisia sekä suunnittelijoita ja arkkitehtejä kautta Pohjois-Euroopan. Oman valikoimamme rinnalla asiakkaidemme käytössä on laaja tilausvalikoima, vahva kumppaniverkosto sekä joustavat räätälöinti- ja mittatilausmahdollisuudet. Asiantuntijamme auttavat sinua löytämään kohteeseesi parhaan mahdollisen ratkaisun!



## KUNDANPASSADE LÖSNINGAR FÖR INVÄNDIG SLUTFINISH

I Dione katalogen har vi samlat de viktigaste produkterna för invändig slutfinish både för nybyggnation och renovering. Från vårt centrallager levererar vi stilrena lister och profiler, högkvalitativa inspektionsluckor samt många andra produkter som hjälper dig att färdigställa utrymmen hållbart och med hög kvalitet.

På vårt lager finns cirka 3 500 artiklar tillgängliga för snabb leverans. Bekanta dig med hela vårt breda sortiment på [www.dione.fi/sv](http://www.dione.fi/sv), där du även hittar bland annat krockskydd, produkter för tillgänglighet och taktila gångstråk.

Vi betjänar återförsäljare, byggproffs samt byggplanerare och arkitekter i hela norra Europa, med vår nästan 50 åriga erfarenhet och expertis. Utöver vårt standard sortiment erbjuder vi ett brett beställnings-sortiment, ett starkt partnersätverk samt flexibla möjligheter till kund Anpassning och måttbeställning. Våra experter hjälper dig att hitta den bästa lösningen för just ditt projekt!



## CUSTOMER-ORIENTED SOLUTIONS FOR INTERIOR FINISHING

In this Dione catalogue, we have compiled the most important interior finishing products from our central warehouse for construction and renovation: stylish trims and profiles, high-quality hatches, and many other products that help you finish spaces with lasting quality and durability.

Around 3,500 items are available for quick delivery from our warehouse. Explore the full range on our website [www.dione.fi/en](http://www.dione.fi/en), where you will also find, among other things, impact protection systems, accessibility and pedestrian guidance products, as well as sanding machines.

We attend to retailers, building industry professionals, as well as designers, and architects across Northern Europe with nearly 50 years of experience. Alongside our own range, our customers have access to a broad made-to-order selection, a strong partner network, and flexible customization and made-to-measure options. Our experts will help you find the best possible solution for your site!

<b>5</b>	<b>SAUMALISTAT</b>	<b>5</b>	<b>SKARVLISTER</b>	<b>5</b>	<b>COVER STRIPS</b>
<b>6</b>	<a href="#">Ruuvi, liima ja Elasticfix</a>	<b>6</b>	<a href="#">Skruv, lim och Elasticfix-montering</a>	<b>6</b>	<a href="#">Screw, glue and Elasticfix fastening</a>
<b>41</b>	<a href="#">Alakisko- ja tulppakiinnitys</a>	<b>41</b>	<a href="#">Underskena och pluggmontering</a>	<b>41</b>	<a href="#">Underrail and plug fastening</a>
<b>53</b>	<a href="#">T-listat</a>	<b>53</b>	<a href="#">T-profiler</a>	<b>53</b>	<a href="#">T-profiles</a>
<b>57</b>	<b>ERITASOLISTAT</b>	<b>57</b>	<b>NIVÅLISTER</b>	<b>57</b>	<b>EDGE TRIMS</b>
<b>58</b>	<a href="#">Ruuvi, liima ja Elasticfix</a>	<b>58</b>	<a href="#">Skruv, lim och Elasticfix-montering</a>	<b>58</b>	<a href="#">Screw, glue and Elasticfix fastening</a>
<b>80</b>	<a href="#">Alakiskokiinnitteiset</a>	<b>80</b>	<a href="#">Underskena</a>	<b>80</b>	<a href="#">Underrail</a>
<b>86</b>	<a href="#">Eritasolistat, tammi</a>	<b>86</b>	<a href="#">Nivålistor i ek</a>	<b>86</b>	<a href="#">Oak edge trims</a>
<b>87</b>	<b>ASKELKULMALISTAT</b>	<b>87</b>	<b>TRAPPKANTLISTER</b>	<b>87</b>	<b>STAIR NOSINGS</b>
<b>88</b>	<a href="#">Ruuvi-, liima- ja tarrakiinnitys</a>	<b>88</b>	<a href="#">Skruv, lim och tejpmontering</a>	<b>88</b>	<a href="#">Screw, glue and tape fastening</a>
<b>120</b>	<a href="#">Liukuesteet</a>	<b>120</b>	<a href="#">Halkskyddsinnlägg</a>	<b>120</b>	<a href="#">Anti-slip</a>
<b>122</b>	<a href="#">Porraskonsolit</a>	<b>122</b>	<a href="#">Trappkonsoler</a>	<b>122</b>	<a href="#">Stair consoles</a>
<b>123</b>	<b>PÄÄTELISTAT</b>	<b>123</b>	<b>AVSLUTNINGSLISTER</b>	<b>123</b>	<b>FINISHING PROFILES</b>
<b>133</b>	<b>JALKALISTAT</b>	<b>133</b>	<b>SOCKLAR</b>	<b>133</b>	<b>SKIRTINGS</b>
<b>158</b>	<a href="#">Käsijohdelistat</a>	<b>158</b>	<a href="#">Ledstångsprofiler</a>	<b>158</b>	<a href="#">Hand rail profiles</a>
<b>158</b>	<a href="#">Pilarinkaulukset</a>	<b>158</b>	<a href="#">Golvsocklar för pelare</a>	<b>158</b>	<a href="#">Column collars</a>
<b>147</b>	<b>KULMASUOJALISTAT</b>	<b>147</b>	<b>HÖRNSKYDDSPROFILER</b>	<b>147</b>	<b>CORNER PROTECTION</b>
<b>163</b>	<b>LAATTALISTAT</b>	<b>163</b>	<b>KAKELLISTER</b>	<b>163</b>	<b>TILE TRIMS</b>
<b>164</b>	<a href="#">Metalliset</a>	<b>164</b>	<a href="#">Av metall</a>	<b>164</b>	<a href="#">Metal</a>
<b>189</b>	<a href="#">Muoviset</a>	<b>189</b>	<a href="#">Av plast</a>	<b>189</b>	<a href="#">Plastic</a>
<b>192</b>	<a href="#">Laattapäätelistat</a>	<b>192</b>	<a href="#">Avslutningsprofiler</a>	<b>192</b>	<a href="#">Finishing profiles</a>
<b>200</b>	<a href="#">T-listat</a>	<b>200</b>	<a href="#">T-profiler</a>	<b>200</b>	<a href="#">T-profiles</a>
<b>201</b>	<a href="#">Laatta-askelkulmat</a>	<b>201</b>	<a href="#">Trappkanter</a>	<b>201</b>	<a href="#">Stair edges</a>
<b>203</b>	<a href="#">Liikuntasaumat</a>	<b>203</b>	<a href="#">Expansionsfogar</a>	<b>203</b>	<a href="#">Expansion joints</a>
<b>206</b>	<a href="#">Boordi-, vesi- ja suihkulistat</a>	<b>206</b>	<a href="#">Dekorlist, vatten- och duschprofil</a>	<b>206</b>	<a href="#">Tile border, waterstop, shower profiles</a>
<b>207</b>	<b>OVI- JA IKKUNATUOTTEET</b>	<b>207</b>	<b>DÖRR- OCH FÖNSTERPRODUKTER</b>	<b>207</b>	<b>DOOR AND WINDOW PRODUCTS</b>
<b>208</b>	<a href="#">Kynnykset</a>	<b>208</b>	<a href="#">Trösklar</a>	<b>208</b>	<a href="#">Thresholds</a>
<b>213</b>	<a href="#">Turkkilevyt</a>	<b>213</b>	<a href="#">Durkplåtar</a>	<b>213</b>	<a href="#">Tear surfaces</a>
<b>214</b>	<a href="#">Tammikynnykset</a>	<b>214</b>	<a href="#">Trösklar i ek</a>	<b>214</b>	<a href="#">Oak thresholds</a>
<b>217</b>	<a href="#">Potkupellit</a>	<b>217</b>	<a href="#">Sparkplåtar</a>	<b>217</b>	<a href="#">Kick plates</a>
<b>218</b>	<a href="#">Viimeistelylistat</a>	<b>218</b>	<a href="#">Avslutningslister</a>	<b>218</b>	<a href="#">Finishing trims</a>
<b>222</b>	<a href="#">Ikkunalaudat</a>	<b>222</b>	<a href="#">Fönsterbänkar</a>	<b>222</b>	<a href="#">Windowsills</a>
<b>225</b>	<b>JOHTOKOTELOT</b>	<b>225</b>	<b>KABELKANALER</b>	<b>225</b>	<b>CABLE DUCTS</b>
<b>231</b>	<b>HOBBY-TUOTTEET</b>	<b>231</b>	<b>HOBBY-PRODUKTER</b>	<b>231</b>	<b>HOBBY PRODUCTS</b>
<b>232</b>	<a href="#">Hobby-listat</a>	<b>232</b>	<a href="#">Hobby-profiler</a>	<b>232</b>	<a href="#">Hobby profiles</a>
<b>255</b>	<a href="#">Dione MEKANO</a>	<b>255</b>	<a href="#">Dione MEKANO</a>	<b>255</b>	<a href="#">Dione MEKANO</a>
<b>265</b>	<b>TARKASTUSLUUKUT</b>	<b>265</b>	<b>INSPEKTIONSLUCKOR</b>	<b>265</b>	<b>ACCESS PANELS</b>
<b>287</b>	<a href="#">Peitelevyt ja tarvikkeet</a>	<b>287</b>	<a href="#">Täckskivor och tillbehör</a>	<b>287</b>	<a href="#">Cover plates and accessories</a>
<b>288</b>	<b>ASENNUSOHJEET</b>	<b>288</b>	<b>MONTERINGSANVISNINGAR</b>	<b>288</b>	<b>INSTALLATION INSTRUCTIONS</b>
<b>292</b>	<b>HAKEMISTO</b>	<b>292</b>	<b>FÖRTECKNING</b>	<b>292</b>	<b>INDEX</b>

# SAUMALISTAT SKARVLISTER COVER STRIPS

## **LUO VIIMEISTELTY VAIKUTELMA. KÄYTÄ MYÖS KYNNYKSENÄ.**

Saumalistoilla tyylittelet ja viimeistelet lattiasi helposti. Voit käyttää saumalistaa koristeellisena ja kestäväenä kynnyksenä, peittää sillä liikuntasaumamat ja luoda huolitellun vaikutelman. Dione-saumalistavalikoimasta löydät useat eri koot sekä erilaiset materiaali- ja väri vaihtoehdot.

Dione-saumalistoista löytyy useita eri asennusvaihtoehtoja eri lattiamateriaaleille: ruuvi kiinnitys, liimakiinnitys, Elasticfix-tarrakiinnitys ja alakisko- tai tulppakiinnitys.

## **GER EN SNYGG FINISH OCH KAN ÄVEN ANVÄNDAS SOM TRÖSKEL.**

Med skarvlisterna ger du enkelt stil och finish för golvet. Du kan använda dem som dekorativa och hållbara trösklar, täcka över rörelsefogar och skapa ett prydligt intryck. Skarvlistsortimentet innefattar olika storlekar samt olika material- och färgalternativ.

Dione-skarvlisterna har olika monteringsalternativ för olika golvmaterial: montering med skruvar eller lim, självhäftning med Elasticfix samt med underskena eller pluggar.

## **CREATE A FINISHED LOOK. USE ALSO AS A THRESHOLD.**

Add style and a smooth finish to your floor with cover strips. You can use a cover strip as a decorative and durable threshold, cover gaps in the flooring and create a finished appearance. The Dione cover strip selection includes a wide range of sizes, materials and colour options.

Dione cover strips come with a range of installation options for different types of flooring: screws, glue, self-adhesive Elasticfix fastening, underrails or nail plugs.

# SAUMALISTAT





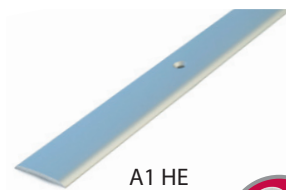
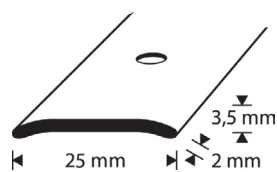

## SKARVLISTER

### COVER STRIPS

ruuvi- tai liimakiinnityksellä  
med skruv eller lim-montering  
with screw or glue fastening



25 mm Sileä, metalliväri | Slät, metallfärg | Smooth, metal colour

TUOTENRO PRODUKTNR PRODUCT NO	VÄRI	FÄRG	COLOUR		PITUUS LÄNGD LENGTH	EAN-KOODI EAN-KOD EAN-CODE
A1 HE1	Hopea-anodisoitu	Silver anodiserad	Silver anodized		1000	 6 417 083 110290
A1 HE2	Hopea-anodisoitu	Silver anodiserad	Silver anodized		2000	 6 417 083 110221
A1 HE3	Hopea-anodisoitu	Silver anodiserad	Silver anodized		3000	 6 417 083 028021
A1 KE1	Kulta-anodisoitu	Guld anodiserad	Gold anodized		1000	 6 417 083 111334
A1 KE2	Kulta-anodisoitu	Guld anodiserad	Gold anodized		2000	 6 417 083 111327
A1 KE3	Kulta-anodisoitu	Guld anodiserad	Gold anodized		3000	 6 417 083 030529
A1 PE1	Pronssi-anodisoitu	Brons anodiserad	Bronze anodized		1000	 6 417 083 111600
A1 PE2	Pronssi-anodisoitu	Brons anodiserad	Bronze anodized		2000	 6 417 083 111624
A1 PE3	Pronssi-anodisoitu	Brons anodiserad	Bronze anodized		3000	 6 417 083 028045

**ruuvi- tai liimakiinnityksellä**  
**med skruv eller lim-montering**  
**with screw or glue fastening**

**SAUMALISTAT**  
**SKARVLISTER**  
**COVER STRIPS**

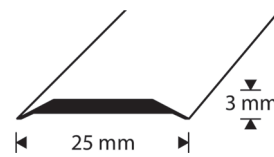

A1 NG-R



25 mm Sileä, metalliväri | Slät, metallfärg | Smooth, metal colour

TUOTENRO PRODUKTNR PRODUCT NO	VÄRI	FÄRG	COLOUR		PITUUS LÄNGD LENGTH	EAN-KOODI EAN-KOD EAN-CODE
A1 NG 90-R ●	Nordic Graphite	Nordic Graphite	Nordic Graphite		900	 6 4 17083 017360
A1 NG 180-R ●	Nordic Graphite	Nordic Graphite	Nordic Graphite		1800	 6 4 17083 017377

- **Poistuva tuote.** Kysy lisää myynnistä
- **Utgående produkt.** Fråga mer hos försäljningen
- **Discontinued product.** Contact sales for more information

**Nordic Graphite** -värisävy saattaa vaihdella valmistuksessa käytettävän harjaustekniikan vuoksi. Nyansen **Nordic Graphite** kan variera beroende på den borstningsteknik som används vid tillverknigen. The **Nordic Graphite** shade may vary according to the brushing technique used in manufacturing.

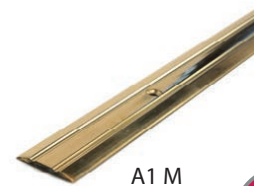
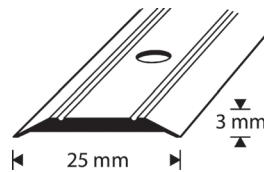

A1 M



25 mm Uritettu, messinki | Spårad, mässing | Grooved, brass

TUOTENRO PRODUKTNR PRODUCT NO	VÄRI	FÄRG	COLOUR		PITUUS LÄNGD LENGTH	EAN-KOODI EAN-KOD EAN-CODE
A1 M 90 ●	Messinki	Mässing	Brass		900	 6 4 17083 111495
A1 M1	Messinki	Mässing	Brass		1000	 6 4 17083 111433
A1 M 180 ●	Messinki	Mässing	Brass		1800	 6 4 17083 111419
A1 M2	Messinki	Mässing	Brass		2000	 6 4 17083 111426
A1 M3	Messinki	Mässing	Brass		3000	 6 4 17083 026539

- **Poistuva tuote.** Kysy lisää myynnistä
- **Utgående produkt.** Fråga mer hos försäljningen
- **Discontinued product.** Contact sales for more information

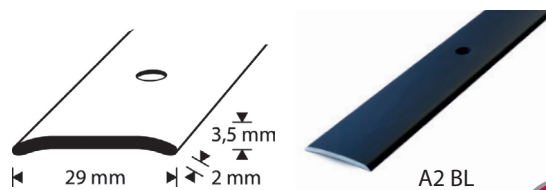
SAUMALISTAT  
SKARVLISTER  
COVER STRIPSruuvi- tai liimakiinnityksellä  
med skruv eller lim-montering  
with screw or glue fastening

29 mm Sileä, metalliväri | Slät, metallfärg | Smooth, metal colour

TUOTENRO PRODUKTNR PRODUCT NO	VÄRI	FÄRG	COLOUR		PITUUS LÄNGD LENGTH	EAN-KOODI EAN-KOD EAN-CODE
A2 BL1	Musta-anodisoitu	Svart anodiserad	Black anodized		1000	 6 417 083 028 571
A2 BL2	Musta-anodisoitu	Svart anodiserad	Black anodized		2000	 6 417 083 030 536
A2 BL3	Musta-anodisoitu	Svart anodiserad	Black anodized		3000	 6 417 083 030 543
A2 HE1	Hopea-anodisoitu	Silver anodiserad	Silver anodized		1000	 6 417 083 121 234
A2 HE2	Hopea-anodisoitu	Silver anodiserad	Silver anodized		2000	 6 417 083 121 227
A2 HE3	Hopea-anodisoitu	Silver anodiserad	Silver anodized		3000	 6 417 083 030 567
A2 KE1	Kulta-anodisoitu	Guld anodiserad	Gold anodized		1000	 6 417 083 121 333
A2 KE2	Kulta-anodisoitu	Guld anodiserad	Gold anodized		2000	 6 417 083 303 029
A2 KE 270 ●	Kulta-anodisoitu	Guld anodiserad	Gold anodized		2700	 6 417 083 112 645
A2 KE3	Kulta-anodisoitu	Guld anodiserad	Gold anodized		3000	 6 417 083 030 512
A2 PE1	Pronssi-anodisoitu	Brons anodiserad	Bronze anodized		1000	 6 417 083 028 052
A2 PE2	Pronssi-anodisoitu	Brons anodiserad	Bronze anodized		2000	 6 417 083 030 574
A2 PE3	Pronssi-anodisoitu	Brons anodiserad	Bronze anodized		3000	 6 417 083 030 581

- **Poistuva tuote.** Kysy lisää myynnistä
- **Utgående produkt.** Fråga mer hos försäljningen
- **Discontinued product.** Contact sales for more information

**ruuvi- tai liimakiinnityksellä**  
**med skruv eller lim-montering**  
**with screw or glue fastening**

**SAUMALISTAT**  
**SKARVLISTER**  
**COVER STRIPS**

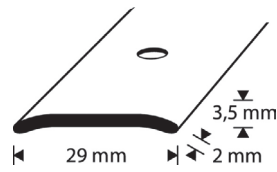

29 mm Sileä, messinki | Slät, mässing | Smooth, brass

TUOTENRO PRODUKTNR PRODUCT NO	VÄRI	FÄRG	COLOUR		PITUUS LÄNGD LENGTH	EAN-KOODI EAN-KOD EAN-CODE
A2 M 90 ●	Messinki	Mässing	Brass		900	 6 4 170 83 12 14 94
A2 M1	Messinki	Mässing	Brass		1000	 6 4 170 83 12 14 32
A2 M 180 ●	Messinki	Mässing	Brass		1800	 6 4 170 83 12 14 18
A2 M2	Messinki	Mässing	Brass		2000	 6 4 170 83 12 14 25
A2 M3	Messinki	Mässing	Brass		3000	 6 4 170 83 02 65 46

- **Poistuva tuote.** Kysy lisää myynnistä
- **Utgående produkt.** Fråga mer hos försäljningen
- **Discontinued product.** Contact sales for more information

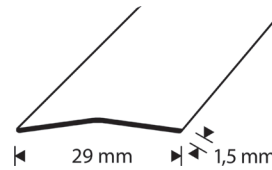

29 mm Sileä, RST | Slät, rostfritt stål | Smooth, stainless steel

TUOTENRO PRODUKTNR PRODUCT NO	VÄRI	FÄRG	COLOUR		PITUUS LÄNGD LENGTH	EAN-KOODI EAN-KOD EAN-CODE
7094605-R	RST	Rostfritt stål	Stainless steel		3000	 6 4 170 83 9 460 59

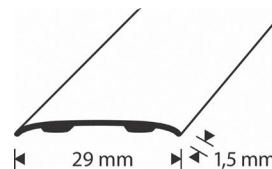

29 mm Sileä, RST | Slät, rostfritt stål | Smooth, stainless steel





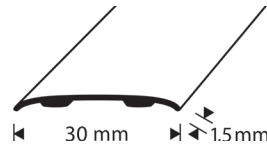

TUOTENRO PRODUKTNR PRODUCT NO	VÄRI	FÄRG	COLOUR		PITUUS LÄNGD LENGTH	EAN-KOODI EAN-KOD EAN-CODE
7093005-R	RST	Rostfritt stål	Stainless steel		3000	 6 4 170 83 9 300 58

**SAUMALISTAT**  
**SKARVLISTER**  
COVER STRIPS

**Elasticfix-kiinnityksellä**  
med Elasticfix-montering  
with Elasticfix fastening







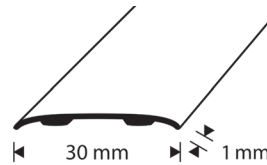

30 mm Sileä, messinki | Slät, mässing | Smooth, brass | ELASTICFIX

TUOTENRO PRODUKTNR PRODUCT NO	VÄRI	FÄRG	COLOUR		PITUUS LÄNGD LENGTH	EAN-KOODI EAN-KOD EAN-CODE
B1 M1	Messinki	Mässing	Brass		1000	 6 417 083 2114 09
B1 M2	Messinki	Mässing	Brass		2000	 6 417 083 2114 23
B1 M3	Messinki	Mässing	Brass		3000	 6 417 083 0266 45



30 mm Sileä, RST | Slät, rostfritt stål | Smooth, stainless steel | ELASTICFIX

TUOTENRO PRODUKTNR PRODUCT NO	VÄRI	FÄRG	COLOUR		PITUUS LÄNGD LENGTH	EAN-KOODI EAN-KOD EAN-CODE
B1 RST 1	RST	Rostfritt stål	Stainless steel		1000	 6 417 083 0278 57
B1 RST 2	RST	Rostfritt stål	Stainless steel		2000	 6 417 083 0278 33
B1 RST 3	RST	Rostfritt stål	Stainless steel		3000	 6 417 083 0278 40

**Elasticfix-kiinnityksellä**  
**med Elasticfix-montering**  
 with Elasticfix fastening

**SAUMALISTAT**  
**SKARVLISTER**  
 COVER STRIPS

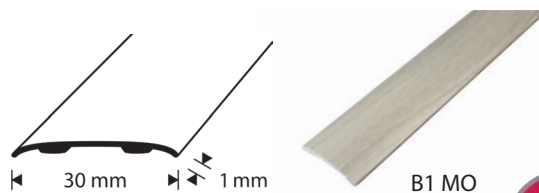

30 mm Sileä, puukuvioitu | Slät, träimitation | Smooth, wood imitation | ELASTICFIX

TUOTENRO PRODUKTNR PRODUCT NO	VÄRI	FÄRG	COLOUR		PITUUS LÄNGD LENGTH	EAN-KOODI EAN-KOD EAN-CODE
B1 CW1	Cotton white	Cotton white	Cotton white		1000	6 4 17083 029066
B1 CW2	Cotton white	Cotton white	Cotton white		2000	6 4 17083 029042
B1 CW3	Cotton white	Cotton white	Cotton white		3000	6 4 17083 029059
B1 LO1	Harmaa tammi	Ljus ek	Light oak		1000	6 4 17083 029097
B1 LO2	Harmaa tammi	Ljus ek	Light oak		2000	6 4 17083 029073
B1 LO3	Harmaa tammi	Ljus ek	Light oak		3000	6 4 17083 029080
B1 MO1	Milky Oak	Milky Oak	Milky Oak		1000	6 4 17083 025549
B1 MO2	Milky Oak	Milky Oak	Milky Oak		2000	6 4 17083 025556
B1 MO3	Milky Oak	Milky Oak	Milky Oak		3000	6 4 17083 025563
B1 NOA1	Natural Oak	Natural Oak	Natural Oak		1000	6 4 17083 025570
B1 NOA2	Natural Oak	Natural Oak	Natural Oak		2000	6 4 17083 025587
B1 NOA3	Natural Oak	Natural Oak	Natural Oak		3000	6 4 17083 025594
B1 PY 90 ●	Pyökki	Bok	Beech		900	6 4 17083 211799
B1 PY 180 ●	Pyökki	Bok	Beech		1800	6 4 17083 211713
B1 PY 270 ●	Pyökki	Bok	Beech		2700	6 4 17083 211706

- **Poistuva tuote.** Kysy lisää myynnistä
- **Utgående produkt.** Fråga mer hos försäljningen
- **Discontinued product.** Contact sales for more information

JATKUU SEURAAVALLA SIVULLA  
 FORTSÄTTER PÅ NÄSTA SIDA  
 CONTINUED ON THE NEXT PAGE







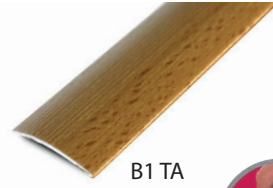
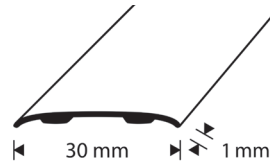

**SAUMALISTAT**  
**SKARVLISTER**  
COVER STRIPS

**Elasticfix-kiinnityksellä**  
med Elasticfix-montering  
with Elasticfix fastening

← JATKOA EDELLISELTÄ SIVULTA  
FORTSÄTTER FRÅN FÖREGÅENDE SIDA  
CONTINUED FROM THE PREVIOUS PAGE



30 mm Sileä, puukuvioitu | Slät, träimitation | Smooth, wood imitation | ELASTICFIX

TUOTENRO PRODUKTNR PRODUCT NO	VÄRI	FÄRG	COLOUR		PITUUS LÄNGD LENGTH	EAN-KOODI EAN-KOD EAN-CODE
B1 TA1	Tammi	Ek	Oak		1000	 6 417083 211843
B1 TA2	Tammi	Ek	Oak		2000	 6 417083 211829
B1 TA3	Tammi	Ek	Oak		3000	 6 417083 028779









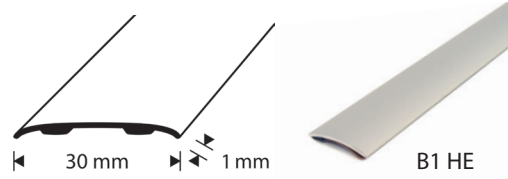

















B1 MO

**Elasticfix-kiinnityksellä**  
med Elasticfix-montering  
with Elasticfix fastening

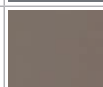
**SAUMALISTAT**  
SKARVLISTER  
COVER STRIPS

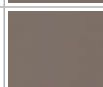

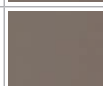





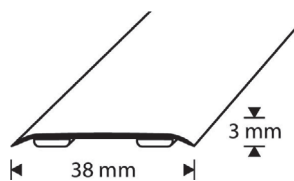















30 mm Sileä, metalliväri | Slät, metallfärg | Smooth, metal colour | ELASTICFIX

TUOTENRO PRODUKTNR PRODUCT NO	VÄRI	FÄRG	COLOUR		PITUUS LÄNGD LENGTH	EAN-KOODI EAN-KOD EAN-CODE
B1 HE1	Hopea-anodisoitu	Silver anodiserad	Silver anodized		1000	 6 4 17083 211232
B1 HE2	Hopea-anodisoitu	Silver anodiserad	Silver anodized		2000	 6 4 17083 211225
B1 HE3	Hopea-anodisoitu	Silver anodiserad	Silver anodized		3000	 6 4 17083 030864
B1 KE1	Kulta-anodisoitu	Guld anodiserad	Gold anodized		1000	 6 4 17083 211331
B1 KE2	Kulta-anodisoitu	Guld anodiserad	Gold anodized		2000	 6 4 17083 211324
B1 KE3	Kulta-anodisoitu	Guld anodiserad	Gold anodized		3000	 6 4 17083 030871
B1 NG1	Nordic Graphite	Nordic Graphite	Nordic Graphite		1000	 6 4 17083 026652
B1 NG2	Nordic Graphite	Nordic Graphite	Nordic Graphite		2000	 6 4 17083 026669
B1 NG3	Nordic Graphite	Nordic Graphite	Nordic Graphite		3000	 6 4 17083 026676
B1 PE1	Pronssi-anodisoitu	Brons anodiserad	Bronze anodized		1000	 6 4 17083 030727
B1 PE2	Pronssi-anodisoitu	Brons anodiserad	Bronze anodized		2000	 6 4 17083 211621
B1 PE3	Pronssi-anodisoitu	Brons anodiserad	Bronze anodized		3000	 6 4 17083 030710

**Nordic Graphite** -värisävy saattaa vaihdella valmistuksessa käytettävän harjaustekniikan vuoksi.  
Nyansen **Nordic Graphite** kan variera beroende på den borstningsteknik som används vid tillverkningen.  
The **Nordic Graphite** shade may vary according to the brushing technique used in manufacturing.

SAUMALISTAT  
SKARVLISTER  
COVER STRIPSElasticfix-kiinnityksellä  
med Elasticfix-montering  
with Elasticfix fastening

38 mm Sileä, metalliväri | Slät, metallfärg | Smooth, metal colour | ELASTICFIX

TUOTENRO PRODUKTNR PRODUCT NO	VÄRI	FÄRG	COLOUR		PITUUS LÄNGD LENGTH	EAN-KOODI EAN-KOD EAN-CODE
B2 BL1	Maalattu musta	Svart målad	Painted black		1000	 6 417 083 022784
B2 BL2	Maalattu musta	Svart målad	Painted black		2000	 6 417 083 022791
B2 BL3	Maalattu musta	Svart målad	Painted black		3000	 6 417 083 028120
B2 CBL1	Carbon black	Carbon black	Carbon black		1000	 6 417 083 037887
B2 CBL2	Carbon black	Carbon black	Carbon black		2000	 6 417 083 037894
B2 CBL3	Carbon black	Carbon black	Carbon black		3000	 6 417 083 037900
B2 NG1	Nordic Graphite	Nordic Graphite	Nordic Graphite		1000	 6 417 083 022722
B2 NG2	Nordic Graphite	Nordic Graphite	Nordic Graphite		2000	 6 417 083 022739
B2 NG3	Nordic Graphite	Nordic Graphite	Nordic Graphite		3000	 6 417 083 026294
B2 WH1	Maalattu valkoinen	Vitmålad	Painted white		1000	 6 417 083 026751
B2 WH2	Maalattu valkoinen	Vitmålad	Painted white		2000	 6 417 083 026768
B2 WH3	Maalattu valkoinen	Vitmålad	Painted white		3000	 6 417 083 026775

 **Nordic Graphite** -värisävy saattaa vaihdella valmistuksessa käytettävän harjaustekniikan vuoksi. Nyanssen **Nordic Graphite** kan variera beroende på den borstningsteknik som används vid tillverkningen. The **Nordic Graphite** shade may vary according to the brushing technique used in manufacturing.

JATKUU SEURAAVALLA SIVULLA  
FORTSÄTTER PÅ NÄSTA SIDA  
CONTINUED ON THE NEXT PAGE



**Elasticfix-kiinnityksellä**  
**med Elasticfix-montering**  
 with Elasticfix fastening







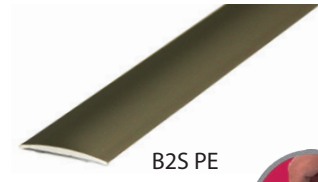
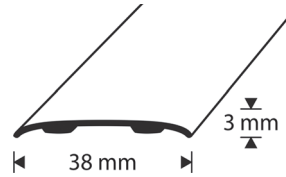











**SAUMALISTAT**  
**SKARVLISTER**  
 COVER STRIPS



JATKOA EDELLISELTÄ SIVULTA  
 FORTSÄTTER FRÅN FÖREGÅENDE SIDA  
 CONTINUED FROM THE PREVIOUS PAGE

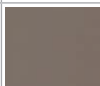

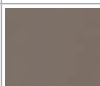
38 mm Sileä, metalliväri | Slät, metallfärg | Smooth, metal colour | ELASTICFIX

TUOTENRO PRODUKTNR PRODUCT NO	VÄRI	FÄRG	COLOUR		PITUUS LÄNGD LENGTH	EAN-KOODI EAN-KOD EAN-CODE
B2S HE1	Hopea-anodisoitu	Silver anodiserad	Silver anodized		1000	 6 417083 022159
B2S HE2	Hopea-anodisoitu	Silver anodiserad	Silver anodized		2000	 6 417083 022166
B2S HE3	Hopea-anodisoitu	Silver anodiserad	Silver anodized		3000	 6 417083 028137
B2S KE1	Kulta-anodisoitu	Guld anodiserad	Gold anodized		1000	 6 417083 022135
B2S KE2	Kulta-anodisoitu	Guld anodiserad	Gold anodized		2000	 6 417083 022142
B2S KE3	Kulta-anodisoitu	Guld anodiserad	Gold anodized		3000	 6 417083 030765
B2S PE1	Pronssi-anodisoitu	Brons anodiserad	Bronze anodized		1000	 6 417083 022173
B2S PE2	Pronssi-anodisoitu	Brons anodiserad	Bronze anodized		2000	 6 417083 022180
B2S PE3	Pronssi-anodisoitu	Brons anodiserad	Bronze anodized		3000	 6 417083 030772

# SAUMALISTAT

## SKARVLISTER

### COVER STRIPS

# Elasticfix-kiinnityksellä

## med Elasticfix-montering

### with Elasticfix fastening

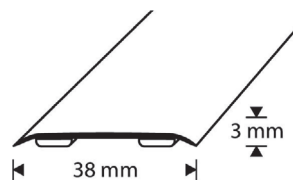

38 mm Sileä, puukuvioitu | Slät, träimitation | Smooth, wood imitation | ELASTICFIX

TUOTENRO PRODUKTNR PRODUCT NO	VÄRI	FÄRG	COLOUR		PITUUS LÄNGD LENGTH	EAN-KOODI EAN-KOD EAN-CODE
B2 ANO1	Aged Nordic Oak	Aged Nordic Oak	Aged Nordic Oak		1000	6 417 083 042 317
B2 ANO2	Aged Nordic Oak	Aged Nordic Oak	Aged Nordic Oak		2000	6 417 083 042 324
B2 ANO3	Aged Nordic Oak	Aged Nordic Oak	Aged Nordic Oak		3000	6 417 083 042 331
B2 CW1	Cotton white	Cotton white	Cotton white		1000	6 417 083 029 158
B2 CW2	Cotton white	Cotton white	Cotton white		2000	6 417 083 029 134
B2 CW3	Cotton white	Cotton white	Cotton white		3000	6 417 083 029 141
B2 GRO1	Granite Oak	Granite Oak	Granite Oak		1000	6 417 083 042 256
B2 GRO2	Granite Oak	Granite Oak	Granite Oak		2000	6 417 083 042 263
B2 GRO3	Granite Oak	Granite Oak	Granite Oak		3000	6 417 083 042 270
B2 KG1	Khaki grey	Khaki grey	Khaki grey		1000	6 417 083 029 189
B2 KG2	Khaki grey	Khaki grey	Khaki grey		2000	6 417 083 029 165
B2 KG3	Khaki grey	Khaki grey	Khaki grey		3000	6 417 083 029 172
B2 KO1	Koivu	Björk	Birch		1000	6 417 083 029 219
B2 KO2	Koivu	Björk	Birch		2000	6 417 083 029 196
B2 KO3	Koivu	Björk	Birch		3000	6 417 083 029 202

JATKUU SEURAAVALLA SIVULLA  
FORTSÄTTER PÅ NÄSTA SIDA  
CONTINUED ON THE NEXT PAGE



**Elasticfix-kiinnityksellä**  
med Elasticfix-montering  
with Elasticfix fastening

**SAUMALISTAT**  
SKARVLISTER  
COVER STRIPS



JATKOA EDELLISELTÄ SIVULTA  
FORTSÄTTER FRÅN FÖREGÅENDE SIDA  
CONTINUED FROM THE PREVIOUS PAGE

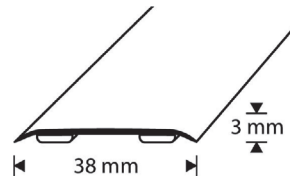

B2 NSO



38 mm Sileä, puukuvioitu | Slät, träimitation | Smooth, wood imitation | ELASTICFIX

TUOTENRO PRODUKTNR PRODUCT NO	VÄRI	FÄRG	COLOUR		PITUUS LÄNGD LENGTH	EAN-KOODI EAN-KOD EAN-CODE
B2 LA1	Valkaistu saarni	Vitkalkad ask	Limed ash		1000	
B2 LA2	Valkaistu saarni	Vitkalkad ask	Limed ash		2000	
B2 LA3	Valkaistu saarni	Vitkalkad ask	Limed ash		3000	
B2 LO1	Harmaa tammi	Ljus ek	Light oak		1000	
B2 LO2	Harmaa tammi	Ljus ek	Light oak		2000	
B2 LO3	Harmaa tammi	Ljus ek	Light oak		3000	
B2 MO1	Milky Oak	Milky Oak	Milky Oak		1000	
B2 MO2	Milky Oak	Milky Oak	Milky Oak		2000	
B2 MO3	Milky Oak	Milky Oak	Milky Oak		3000	
B2 NOA1	Natural Oak	Natural Oak	Natural Oak		1000	
B2 NOA2	Natural Oak	Natural Oak	Natural Oak		2000	
B2 NOA3	Natural Oak	Natural Oak	Natural Oak		3000	
B2 NSO1 ●	Natural Sand Oak	Natural Sand Oak	Natural Sand Oak		1000	
B2 NSO2 ●	Natural Sand Oak	Natural Sand Oak	Natural Sand Oak		2000	
B2 NSO3 ●	Natural Sand Oak	Natural Sand Oak	Natural Sand Oak		3000	

- **Poistuva tuote.** Kysy lisää myynnistä
- **Utgående produkt.** Fråga mer hos försäljningen
- **Discontinued product.** Contact sales for more information

JATKUU SEURAAVALLA SIVULLA  
FORTSÄTTER PÅ NÄSTA SIDA  
CONTINUED ON THE NEXT PAGE

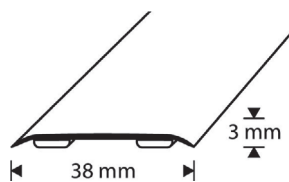

SAUMALISTAT  
SKARVLISTER  
COVER STRIPSElasticfix-kiinnityksellä  
med Elasticfix-montering  
with Elasticfix fasteningJATKOA EDELLISELTÄ SIVULTA  
FORTSÄTTER FRÅN FÖREGÅENDE SIDA  
CONTINUED FROM THE PREVIOUS PAGE

B2 ROA\*



38 mm Sileä, puukuvioitu | Slät, träimitation | Smooth, wood imitation | ELASTICFIX

TUOTENRO PRODUKTNR PRODUCT NO	VÄRI	FÄRG	COLOUR		PITUUS LÄNGD LENGTH	EAN-KOODI EAN-KOD EAN-CODE
B2 PH1	Pähkinä	Valnöt	Walnut		1000	
B2 PH2	Pähkinä	Valnöt	Walnut		2000	
B2 PH3	Pähkinä	Valnöt	Walnut		3000	
B2 PY1 ●	Pyökki	Bok	Beech		1000	
B2 PY2 ●	Pyökki	Bok	Beech		2000	
B2 PY 270 ●	Pyökki	Bok	Beech		2700	
B2 PY3 ●	Pyökki	Bok	Beech		3000	
B2 ROA1*	Aito tammi	Äkta ek	Real oak		1000	
B2 ROA2*	Aito tammi	Äkta ek	Real oak		2000	
B2 ROA3*	Aito tammi	Äkta ek	Real oak		3000	
B2 TA1	Tammi	Ek	Oak		1000	
B2 TA2	Tammi	Ek	Oak		2000	
B2 TA3	Tammi	Ek	Oak		3000	
B2 WE1	Wenge	Wenge	Wenge		1000	
B2 WE2	Wenge	Wenge	Wenge		2000	
B2 WE3	Wenge	Wenge	Wenge		3000	

- **Poistuva tuote.** Kysy lisää myynnistä
- **Utgående produkt.** Fråga mer hos försäljningen
- **Discontinued product.** Contact sales for more information

\*) B2 ROA aito tammiviilu | äkta ekfaner | real oak veneer

**Elasticfix-kiinnityksellä**  
med Elasticfix-montering  
with Elasticfix fastening

**SAUMALISTAT**  
SKARVLISTER  
COVER STRIPS

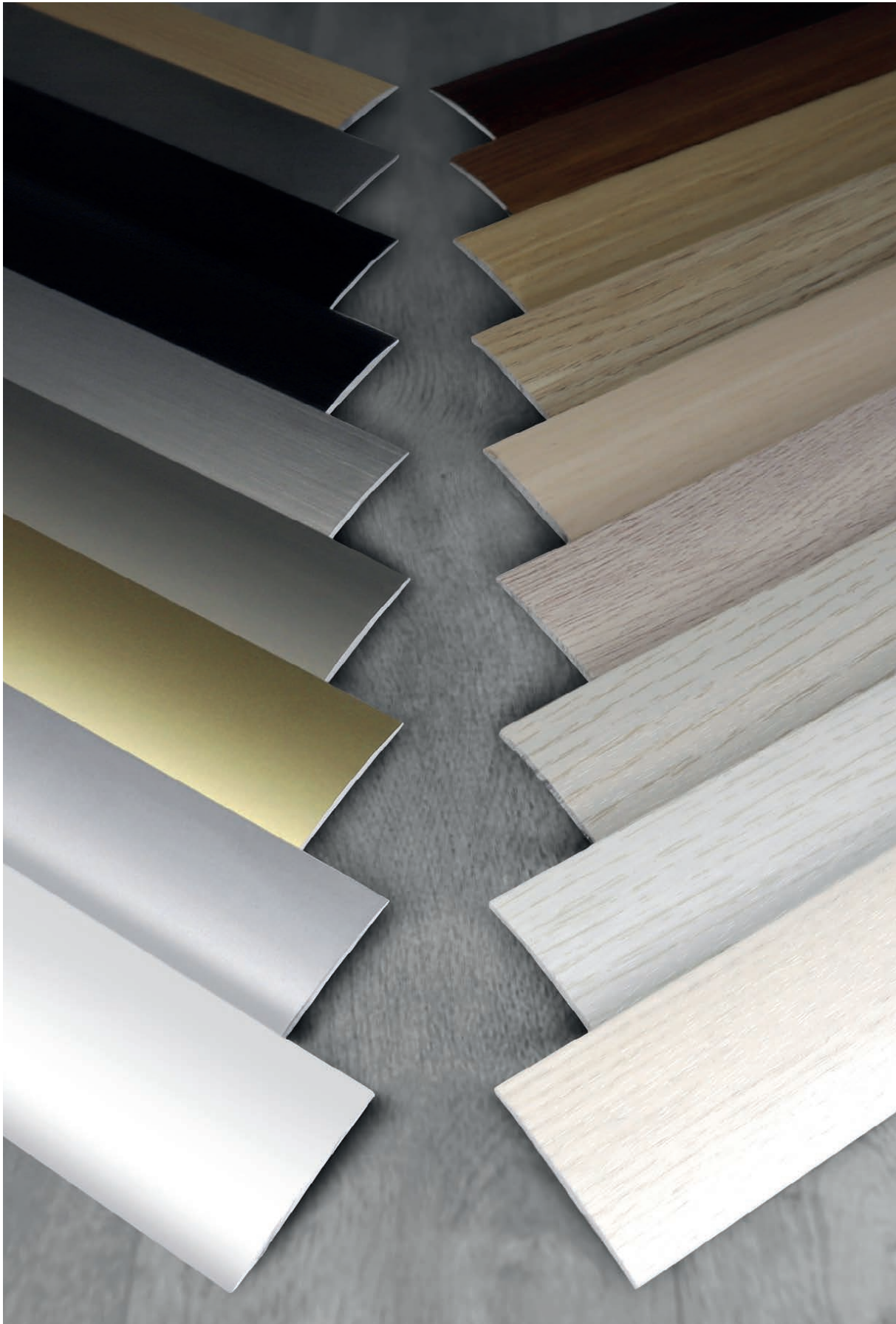

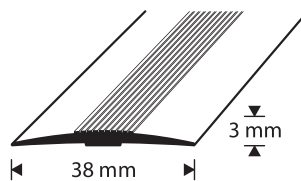
SAUMALISTAT  
SKARVLISTER  
COVER STRIPSElasticfix-kiinnityksellä  
med Elasticfix-montering  
with Elasticfix fastening

B2 HE



38 mm Rihlattu, metalliväri | Råfflad, metallfärg | Ridged, metal colour | ELASTICFIX





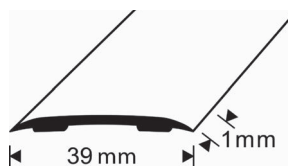

TUOTENRO PRODUKTNR PRODUCT NO	VÄRI	FÄRG	COLOUR		PITUUS LÄNGD LENGTH	EAN-KOODI EAN-KOD EAN-CODE
B2 HE1	Hopea-anodisoitu	Silver anodiserad	Silver anodized		1000	 6 417 083 221231
B2 HE2	Hopea-anodisoitu	Silver anodiserad	Silver anodized		2000	 6 417 083 221224
B2 HE3	Hopea-anodisoitu	Silver anodiserad	Silver anodized		3000	 6 417 083 030734
B2 KE1	Kulta-anodisoitu	Guld anodiserad	Gold anodized		1000	 6 417 083 221330
B2 KE2	Kulta-anodisoitu	Guld anodiserad	Gold anodized		2000	 6 417 083 221323
B2 KE3	Kulta-anodisoitu	Guld anodiserad	Gold anodized		3000	 6 417 083 030741
B2 PE1	Pronssi-anodisoitu	Brons anodiserad	Bronze anodized		1000	 6 417 083 221118
B2 PE2	Pronssi-anodisoitu	Brons anodiserad	Bronze anodized		2000	 6 417 083 221620
B2 PE3	Pronssi-anodisoitu	Brons anodiserad	Bronze anodized		3000	 6 417 083 030758

**Elasticfix-kiinnitysellä**  
 med Elasticfix-montering  
 with Elasticfix fastening

**SAUMALISTAT**  
 SKARVLISTER  
 COVER STRIPS



39 mm Sileä, RST | Slät, rostfritt stål | Smooth, stainless steel | ELASTICFIX



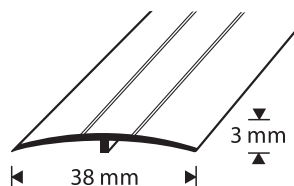

TUOTENRO PRODUKTNR PRODUCT NO	VÄRI	FÄRG	COLOUR		PITUUS LÄNGD LENGTH	EAN-KOODI EAN-KOD EAN-CODE
B2 RST 1	RST	Rostfritt stål	Stainless steel		1000	 6 417083 025938
B2 RST 2	RST	Rostfritt stål	Stainless steel		2000	 6 417083 025952
B2 RST 3	RST	Rostfritt stål	Stainless steel		3000	 6 417083 025945



925 TA



38 mm Uritettu, puukuvioitu | Spårad, träimitation | Grooved, wood imitation | ELASTICFIX  
 Muovi | Plast | Plastic

TUOTENRO PRODUKTNR PRODUCT NO	VÄRI	FÄRG	COLOUR		PITUUS LÄNGD LENGTH	EAN-KOODI EAN-KOD EAN-CODE
925 TA 90	Tammi	Ek	Oak		900	 6 417083 025303
925 TA 180	Tammi	Ek	Oak		1800	 6 417083 025310

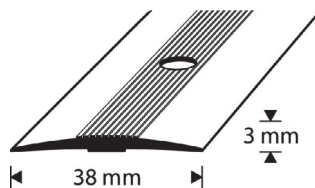
SAUMALISTAT  
SKARVLISTER  
COVER STRIPSruuvi- tai liimakiinnityksellä  
med skruv eller lim-montering  
with screw or glue fastening

A3 HE



38 mm Rihlattu, metalliväri | Räfflad, metallfärg | Ridged, metal colour

TUOTENRO PRODUKTNR PRODUCT NO	VÄRI	FÄRG	COLOUR		PITUUS LÄNGD LENGTH	EAN-KOODI EAN-KOD EAN-CODE
A3 A 90 ●	Alumiini	Aluminium	Aluminium		900	6 417 083 131103
A3 A1 ●	Alumiini	Aluminium	Aluminium		1000	6 417 083 026553
A3 A2 ●	Alumiini	Aluminium	Aluminium		2000	6 417 083 026560
A3 A3 ●	Alumiini	Aluminium	Aluminium		3000	6 417 083 026577
A3 BL1	Musta-anodisoitu	Svart anodiserad	Black anodized		1000	6 417 083 030611
A3 BL2	Musta-anodisoitu	Svart anodiserad	Black anodized		2000	6 417 083 030598
A3 BL3	Musta-anodisoitu	Svart anodiserad	Black anodized		3000	6 417 083 030604
A3 HE1	Hopea-anodisoitu	Silver anodiserad	Silver anodized		1000	6 417 083 131233
A3 HE2	Hopea-anodisoitu	Silver anodiserad	Silver anodized		2000	6 417 083 131226
A3 HE3	Hopea-anodisoitu	Silver anodiserad	Silver anodized		3000	6 417 083 030628
A3 KE1	Kulta-anodisoitu	Guld anodiserad	Gold anodized		1000	6 417 083 131332
A3 KE2	Kulta-anodisoitu	Guld anodiserad	Gold anodized		2000	6 417 083 131325
A3 KE3	Kulta-anodisoitu	Guld anodiserad	Gold anodized		3000	6 417 083 028069

- **Poistuva tuote.** Kysy lisää myynnistä
- **Utgående produkt.** Fråga mer hos försäljningen
- **Discontinued product.** Contact sales for more information

JÄTKUU SEURAAVALLA SIVULLA  
FORTSÄTTER PÅ NÄSTA SIDA  
CONTINUED ON THE NEXT PAGE



**ruuvi- tai liimakiinnityksellä**  
med skruv eller lim-montering  
with screw or glue fastening

**SAUMALISTAT**  
SKARVLISTER  
COVER STRIPS

JATKOA EDELLISELTÄ SIVULTA  
FORTSÄTTER FRÅN FÖREGÅENDE SIDA  
CONTINUED FROM THE PREVIOUS PAGE

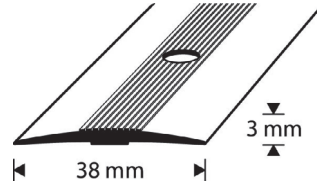

38 mm Rihlattu, metalliväri | Räfblad, metallfärg | Ridged, metal colour

TUOTENRO PRODUKTNR PRODUCT NO	VÄRI	FÄRG	COLOUR		PITUUS LÄNGD LENGTH	EAN-KOODI EAN-KOD EAN-CODE
A3 KR1	Kromi-anodisoitu	Krom anodiserad	Chrome anodized		1000	6 4 17 08 3 0 2 6 5 8 4
A3 KR 180 ●	Kromi-anodisoitu	Krom anodiserad	Chrome anodized		1800	6 4 17 08 3 1 3 1 9 1 2
A3 KR2	Kromi-anodisoitu	Krom anodiserad	Chrome anodized		2000	6 4 17 08 3 0 2 6 5 9 1
A3 KR3	Kromi-anodisoitu	Krom anodiserad	Chrome anodized		3000	6 4 17 08 3 0 2 6 6 0 7
A3 PE1	Pronssi-anodisoitu	Brons anodiserad	Bronze anodized		1000	6 4 17 08 3 1 3 1 5 9 2
A3 PE2	Pronssi-anodisoitu	Brons anodiserad	Bronze anodized		2000	6 4 17 08 3 1 3 1 6 0 8
A3 PE3	Pronssi-anodisoitu	Brons anodiserad	Bronze anodized		3000	6 4 17 08 3 0 2 8 0 7 6

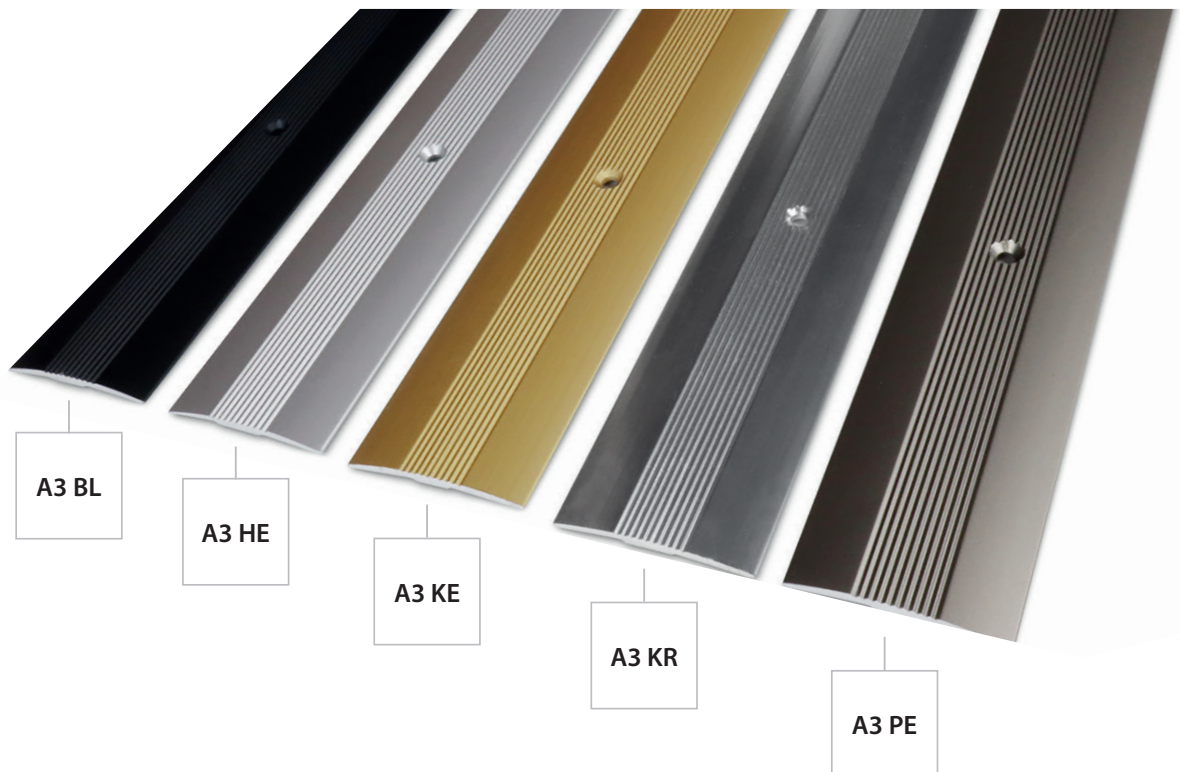

# SAUMALISTAT



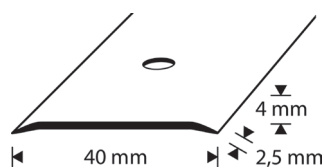

## SKARVLISTER

### COVER STRIPS

ruuvi- tai liimakiinnityksellä  
med skruv eller lim-montering  
with screw or glue fastening



40 mm Sileä, metalliväri | Slät, metallfärg | Smooth, metal colour

TUOTENRO PRODUKTNR PRODUCT NO	VÄRI	FÄRG	COLOUR		PITUUS LÄNGD LENGTH	EAN-KOODI EAN-KOD EAN-CODE
A4 BL1	Musta-anodisoitu	Svart anodiserad	Black anodized		1000	 6 417 083 030642
A4 BL 180 ●	Musta-anodisoitu	Svart anodiserad	Black anodized		1800	 6 417 083 404313
A4 BL2	Musta-anodisoitu	Svart anodiserad	Black anodized		2000	 6 417 083 030635
A4 BL3	Musta-anodisoitu	Svart anodiserad	Black anodized		3000	 6 417 083 028083
A4 HE1	Hopea-anodisoitu	Silver anodiserad	Silver anodized		1000	 6 417 083 112690
A4 HE2	Hopea-anodisoitu	Silver anodiserad	Silver anodized		2000	 6 417 083 112713
A4 HE3	Hopea-anodisoitu	Silver anodiserad	Silver anodized		3000	 6 417 083 028090
A4 KE1	Kulta-anodisoitu	Guld anodiserad	Gold anodized		1000	 6 417 083 404030
A4 KE2	Kulta-anodisoitu	Guld anodiserad	Gold anodized		2000	 6 417 083 404023
A4 KE3	Kulta-anodisoitu	Guld anodiserad	Gold anodized		3000	 6 417 083 030659
A4 PE1	Pronssi-anodisoitu	Brons anodiserad	Bronze anodized		1000	 6 417 083 030680
A4 PE2	Pronssi-anodisoitu	Brons anodiserad	Bronze anodized		2000	 6 417 083 030666
A4 PE3	Pronssi-anodisoitu	Brons anodiserad	Bronze anodized		3000	 6 417 083 030673





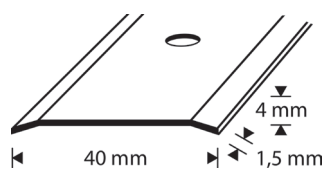

- **Poistuva tuote.** Kysy lisää myynnistä
- **Utgående produkt.** Fråga mer hos försäljningen
- **Discontinued product.** Contact sales for more information

**ruuvi- tai liimakiinnityksellä**  
**med skruv eller lim-montering**  
 with screw or glue fastening

**SAUMALISTAT**  
**SKARVLISTER**  
 COVER STRIPS



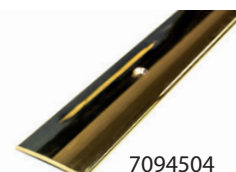
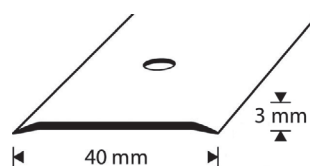

40 mm Sileä, RST | Slät, rostfritt stål | Smooth, stainless steel

TUOTENRO PRODUKTNR PRODUCT NO	VÄRI	FÄRG	COLOUR		PITUUS LÄNGD LENGTH	EAN-KOODI EAN-KOD EAN-CODE
A4 RST 1	RST	Rostfritt stål	Stainless steel		1000	 6 417083 027673
A4 RST 2	RST	Rostfritt stål	Stainless steel		2000	 6 417083 027697
7095305	RST	Rostfritt stål	Stainless steel		3000	 6 417083 953514



40 mm Sileä, messinki | Slät, mässing | Smooth, brass

TUOTENRO PRODUKTNR PRODUCT NO	VÄRI	FÄRG	COLOUR		PITUUS LÄNGD LENGTH	EAN-KOODI EAN-KOD EAN-CODE
7094504	Messinki	Mässing	Brass		3000	 6 417083 945045

# SAUMALISTAT SKARVLISTER COVER STRIPS

ruuvi- tai liimakiinnityksellä  
med skruv eller lim-montering  
with screw or glue fastening

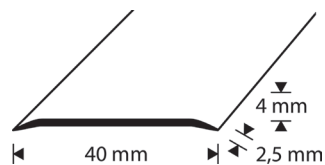

40 mm Sileä, metalliväri | Slät, metallfärg | Smooth, metal colour

TUOTENRO PRODUKTNR PRODUCT NO	VÄRI	FÄRG	COLOUR		PITUUS LÄNGD LENGTH	EAN-KOODI EAN-KOD EAN-CODE
A4 NG 90-R ●	Nordic Graphite	Nordic Graphite	Nordic Graphite		900	 6 417083 017421
A4 NG1-R	Nordic Graphite	Nordic Graphite	Nordic Graphite		1000	 6 417083 026409
A4 NG 180-R ●	Nordic Graphite	Nordic Graphite	Nordic Graphite		1800	 6 417083 017438
A4 NG2-R	Nordic Graphite	Nordic Graphite	Nordic Graphite		2000	 6 417083 026416
A4 NG3-R	Nordic Graphite	Nordic Graphite	Nordic Graphite		3000	 6 417083 026423

- **Poistuva tuote.** Kysy lisää myynnistä
- **Utgående produkt.** Fråga mer hos försäljningen
- **Discontinued product.** Contact sales for more information

**Nordic Graphite** -värisävy saattaa vaihdella valmistuksessa käytettävän harjaustekniikan vuoksi. Nyansen **Nordic Graphite** kan variera beroende på den borstningsteknik som används vid tillverkningen. The **Nordic Graphite** shade may vary according to the brushing technique used in manufacturing.

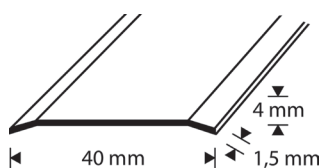

40 mm Sileä, RST | Slät, rostfritt stål | Smooth, stainless steel

TUOTENRO PRODUKTNR PRODUCT NO	VÄRI	FÄRG	COLOUR		PITUUS LÄNGD LENGTH	EAN-KOODI EAN-KOD EAN-CODE
7095305-R	RST	Rostfritt stål	Stainless steel		3000	 6 417083 953057

**ruuvi- tai liimakiinnityksellä**  
**med skruv eller lim-montering**  
 with screw or glue fastening

**SAUMALISTAT**  
**SKARVLISTER**  
 COVER STRIPS

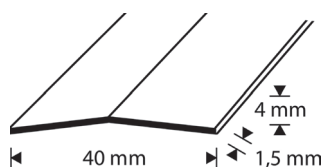

40 mm Sileä, RST | Slät, rostfritt stål | Smooth, stainless steel



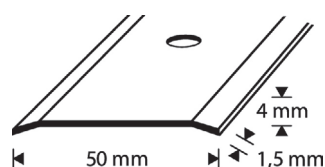

TUOTENRO PRODUKTNR PRODUCT NO	VÄRI	FÄRG	COLOUR		PITUUS LÄNGD LENGTH	EAN-KOODI EAN-KOD EAN-CODE
7094505-R	RST	Rostfritt stål	Stainless steel		3000	 6 417083 945052



7094405



50 mm Sileä, metalli | Slät, metall | Smooth, metal

TUOTENRO PRODUKTNR PRODUCT NO	VÄRI	FÄRG	COLOUR		PITUUS LÄNGD LENGTH	EAN-KOODI EAN-KOD EAN-CODE
7094404	Messinki	Mässing	Brass		3000	 6 417083 944048
7094405	RST	Rostfritt stål	Stainless steel		3000	 6 417083 944512

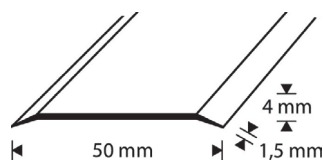

50 mm Sileä, RST | Slät, rostfritt stål | Smooth, stainless steel

TUOTENRO PRODUKTNR PRODUCT NO	VÄRI	FÄRG	COLOUR		PITUUS LÄNGD LENGTH	EAN-KOODI EAN-KOD EAN-CODE
7094405-R	RST	Rostfritt stål	Stainless steel		3000	 6 417083 944055

**SAUMALISTAT**  
**SKARVLISTER**  
**COVER STRIPS**

**ruuvi- tai liimakiinnityksellä**  
**med skruv eller lim-montering**  
**with screw or glue fastening**

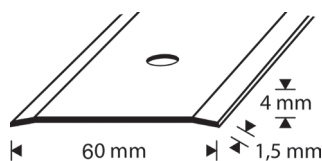

60 mm Sileä, RST | Slät, rostfritt stål | Smooth, stainless steel

TUOTENRO PRODUKTNR PRODUCT NO	VÄRI	FÄRG	COLOUR		PITUUS LÄNGD LENGTH	EAN-KOODI EAN-KOD EAN-CODE
7094905	RST	Rostfritt stål	Stainless steel		3000	 6 417083 949159

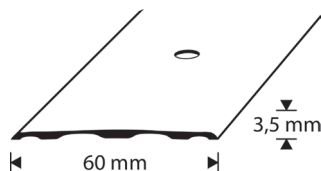





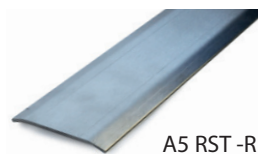
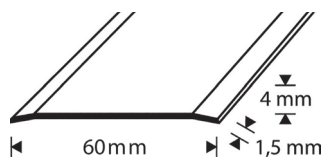

60 mm Sileä, messinki | Slät, mässing | Smooth, brass

TUOTENRO PRODUKTNR PRODUCT NO	VÄRI	FÄRG	COLOUR		PITUUS LÄNGD LENGTH	EAN-KOODI EAN-KOD EAN-CODE
7094904	Messinki	Mässing	Brass		3000	 6 417083 949043



60 mm Sileä, RST | Slät, rostfritt stål | Smooth, stainless steel

TUOTENRO PRODUKTNR PRODUCT NO	VÄRI	FÄRG	COLOUR		PITUUS LÄNGD LENGTH	EAN-KOODI EAN-KOD EAN-CODE
A5 RST 1-R	RST	Rostfritt stål	Stainless steel		1000	 6 417083 027727
A5 RST 2-R	RST	Rostfritt stål	Stainless steel		2000	 6 417083 027710
7094905-R	RST	Rostfritt stål	Stainless steel		3000	 6 417083 949050

ruuvi- tai liimakiinnityksellä  
med skruv eller lim-montering  
with screw or glue fastening

SAUMALISTAT  
SKARVLISTER  
COVER STRIPS

Saumalistat  
Skarvlister  
Cover strips

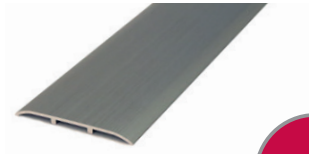
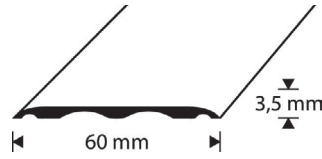

60 mm Sileä, metalliväri | Slät, metallfärg | Smooth, metal colour

TUOTENRO PRODUKTNR PRODUCT NO	VÄRI	FÄRG	COLOUR		PITUUS LÄNGD LENGTH	EAN-KOODI EAN-KOD EAN-CODE
A5 NG1-R	Nordic Graphite	Nordic Graphite	Nordic Graphite		1000	 6 4 17083 026430
A5 NG2-R	Nordic Graphite	Nordic Graphite	Nordic Graphite		2000	 6 4 17083 026447
A5 NG3-R	Nordic Graphite	Nordic Graphite	Nordic Graphite		3000	 6 4 17083 026454

 **Nordic Graphite** -värisävy saattaa vaihdella valmistuksessa käytettävän harjaustekniikan vuoksi.  
Nyansen **Nordic Graphite** kan variera beroende på den borstningsteknik som används vid tillverkningen.  
The **Nordic Graphite** shade may vary according to the brushing technique used in manufacturing.

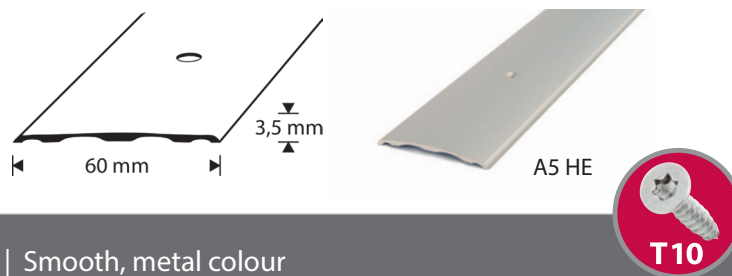
SAUMALISTAT  
SKARVLISTER  
COVER STRIPSruuvi- tai liimakiinnityksellä  
med skruv eller lim-montering  
with screw or glue fastening

60 mm Sileä, metalliväri | Slät, metallfärg | Smooth, metal colour

TUOTENRO PRODUKTNR PRODUCT NO	VÄRI	FÄRG	COLOUR		PITUUS LÄNGD LENGTH	EAN-KOODI EAN-KOD EAN-CODE
A5 HE1	Hopea-anodisoitu	Silver anodiserad	Silver anodized		1000	 6 417 083 022 074
A5 HE2	Hopea-anodisoitu	Silver anodiserad	Silver anodized		2000	 6 417 083 022 081
A5 HE3	Hopea-anodisoitu	Silver anodiserad	Silver anodized		3000	 6 417 083 030 697
A5 KE1	Kulta-anodisoitu	Guld anodiserad	Gold anodized		1000	 6 417 083 949 302
A5 KE2	Kulta-anodisoitu	Guld anodiserad	Gold anodized		2000	 6 417 083 949 326
A5 KE3	Kulta-anodisoitu	Guld anodiserad	Gold anodized		3000	 6 417 083 030 703
A5 KR 90 ●	Kromi-anodisoitu	Krom anodiserad	Chrome anodized		900	 6 417 083 949 982
A5 KR 180 ●	Kromi-anodisoitu	Krom anodiserad	Chrome anodized		1800	 6 417 083 949 913
A5 KR 270 ●	Kromi-anodisoitu	Krom anodiserad	Chrome anodized		2700	 6 417 083 949 098
A5 PE1	Pronssi-anodisoitu	Brons anodiserad	Bronze anodized		1000	 6 417 083 028 113
A5 PE2	Pronssi-anodisoitu	Brons anodiserad	Bronze anodized		2000	 6 417 083 949 623
A5 PE3	Pronssi-anodisoitu	Brons anodiserad	Bronze anodized		3000	 6 417 083 028 106

- **Poistuva tuote.** Kysy lisää myynnistä
- **Utgående produkt.** Fråga mer hos försäljningen
- **Discontinued product.** Contact sales for more information

 **Nordic Graphite** -värisävy saattaa vaihdella valmistuksessa käytettävän harjaustekniikan vuoksi. Nyansen **Nordic Graphite** kan variera beroende på den borstningsteknik som används vid tillverkningen. The **Nordic Graphite** shade may vary according to the brushing technique used in manufacturing.







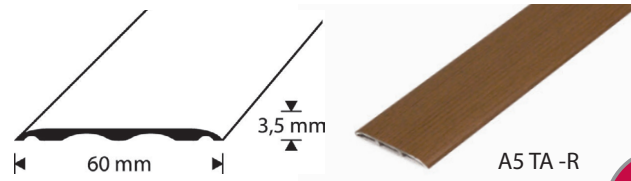







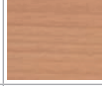

liimakiinnityksellä  
med lim-montering  
with glue fastening

SAUMALISTAT  
SKARVLISTER  
COVER STRIPS

Saumalistat  
Skarvlister  
Cover strips



60 mm Sileä, puukuviointu | Slät, träimitation | Smooth, wood imitation

TUOTENRO PRODUKTNR PRODUCT NO	VÄRI	FÄRG	COLOUR		PITUUS LÄNGD LENGTH	EAN-KOODI EAN-KOD EAN-CODE
A5 PH1-R	Pähkinä	Valnöt	Walnut		1000	
A5 PH2-R	Pähkinä	Valnöt	Walnut		2000	
A5 PH3-R	Pähkinä	Valnöt	Walnut		3000	
A5 PY 180-R ●	Pyökki	Bok	Beech		1800	
A5 PY 270-R ●	Pyökki	Bok	Beech		2700	
A5 TA1-R	Tammi	Ek	Oak		1000	
A5 TA2-R	Tammi	Ek	Oak		2000	
A5 TA3-R	Tammi	Ek	Oak		3000	

- **Poistuva tuote.** Kysy lisää myynnistä
- **Utgående produkt.** Fråga mer hos försäljningen
- **Discontinued product.** Contact sales for more information

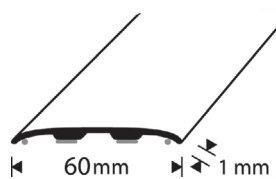
SAUMALISTAT  
SKARVLISTER  
COVER STRIPSElasticfix-kiinnityksellä  
med Elasticfix-montering  
with Elasticfix fastening

60 mm Sileä, puukuvioitu | Slät, träimitation | Smooth, wood imitation | ELASTICFIX

TUOTENRO PRODUKTNR PRODUCT NO	VÄRI	FÄRG	COLOUR		PITUUS LÄNGD LENGTH	EAN-KOODI EAN-KOD EAN-CODE
B60 CW1	Cotton white	Cotton white	Cotton white		1000	
B60 CW2	Cotton white	Cotton white	Cotton white		2000	
B60 CW3	Cotton white	Cotton white	Cotton white		3000	
B60 LO1	Harmaa tammi	Ljus ek	Light oak		1000	
B60 LO2	Harmaa tammi	Ljus ek	Light oak		2000	
B60 LO3	Harmaa tammi	Ljus ek	Light oak		3000	
B60 MO1	Milky Oak	Milky Oak	Milky Oak		1000	
B60 MO2	Milky Oak	Milky Oak	Milky Oak		2000	
B60 MO3	Milky Oak	Milky Oak	Milky Oak		3000	
B60 NOA1	Natural Oak	Natural Oak	Natural Oak		1000	
B60 NOA2	Natural Oak	Natural Oak	Natural Oak		2000	
B60 NOA3	Natural Oak	Natural Oak	Natural Oak		3000	
B60 ROA1*	Aito tammi	Äkta ek	Real oak		1000	
B60 ROA2*	Aito tammi	Äkta ek	Real oak		2000	
B60 ROA3*	Aito tammi	Äkta ek	Real oak		3000	

\*) **B60 ROA** aito tammiviilu | äkta ekfaner | real oak veneerJATKUU SEURAAVALLA SIVULLA  
FORTSÄTTER PÅ NÄSTA SIDA  
CONTINUED ON THE NEXT PAGE

**Elasticfix-kiinnityksellä**  
 med Elasticfix-montering  
 with Elasticfix fastening

**SAUMALISTAT**  
 SKARVLISTER  
 COVER STRIPS



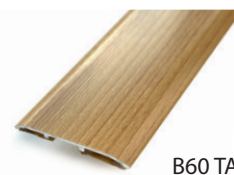
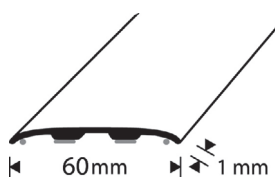



JATKOJA EDELLISELTÄ SIVULTA  
 FORTSÄTTER FRÅN FÖREGÅENDE SIDA  
 CONTINUED FROM THE PREVIOUS PAGE



B60 TA



60 mm Sileä, puukuvioitu | Slät, träimitation | Smooth, wood imitation | ELASTICFIX

TUOTENRO PRODUKTNR PRODUCT NO	VÄRI	FÄRG	COLOUR		PITUUS LÄNGD LENGTH	EAN-KOODI EAN-KOD EAN-CODE
B60 TA1	Tammi	Ek	Oak		1000	 6 4 17083 023217
B60 TA2	Tammi	Ek	Oak		2000	 6 4 17083 023224
B60 TA3	Tammi	Ek	Oak		3000	 6 4 17083 023231



B60 MO

B60 ROA

B60 NOA

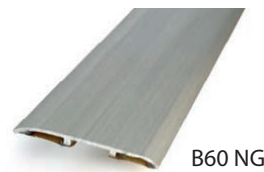
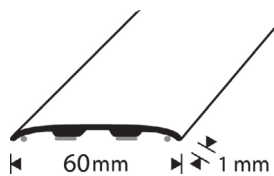
SAUMALISTAT  
SKARVLISTER  
COVER STRIPSElasticfix-kiinnityksellä  
med Elasticfix-montering  
with Elasticfix fastening

60 mm Sileä, metalliväri | Slät, metallfärg | Smooth, metal colour | ELASTICFIX

TUOTENRO PRODUKTNR PRODUCT NO	VÄRI	FÄRG	COLOUR		PITUUS LÄNGD LENGTH	EAN-KOODI EAN-KOD EAN-CODE
B60 CBL1	Carbon black	Carbon black	Carbon black		1000	6 417 083 035821
B60 CBL2	Carbon black	Carbon black	Carbon black		2000	6 417 083 035838
B60 CBL3	Carbon black	Carbon black	Carbon black		3000	6 417 083 035845
B60 HE1	Hopea-anodisoitu	Silver anodiserad	Silver anodized		1000	6 417 083 022876
B60 HE2	Hopea-anodisoitu	Silver anodiserad	Silver anodized		2000	6 417 083 022883
B60 HE3	Hopea-anodisoitu	Silver anodiserad	Silver anodized		3000	6 417 083 022890
B60 NG1	Nordic Graphite	Nordic Graphite	Nordic Graphite		1000	6 417 083 022906
B60 NG2	Nordic Graphite	Nordic Graphite	Nordic Graphite		2000	6 417 083 022913
B60 NG3	Nordic Graphite	Nordic Graphite	Nordic Graphite		3000	6 417 083 022920
B60 WH1	Maalattu valkoinen	Vitmålad	Painted white		1000	6 417 083 035852
B60 WH2	Maalattu valkoinen	Vitmålad	Painted white		2000	6 417 083 035869
B60 WH3	Maalattu valkoinen	Vitmålad	Painted white		3000	6 417 083 035876

 **Nordic Graphite** -värisävy saattaa vaihdella valmistuksessa käytettävän harjaustekniikan vuoksi.  
Nyansen **Nordic Graphite** kan variera beroende på den borstningsteknik som används vid tillverkningen.  
The **Nordic Graphite** shade may vary according to the brushing technique used in manufacturing.

**ruuvi- tai liimakiinnityksellä**  
**med skruv eller lim-montering**  
 with screw or glue fastening

**SAUMALISTAT**  
**SKARVLISTER**  
 COVER STRIPS

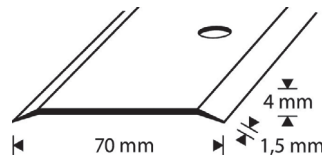

70 mm Sileä, RST | Slät, rostfritt stål | Smooth, stainless steel  
 Sivurei'itetty | Sidoborrad | Side drilled

TUOTENRO PRODUKTNR PRODUCT NO	VÄRI	FÄRG	COLOUR		PITUUS LÄNGD LENGTH	EAN-KOODI EAN-KOD EAN-CODE
7095015	RST	Rostfritt stål	Stainless steel		3000	 6 417083 950155

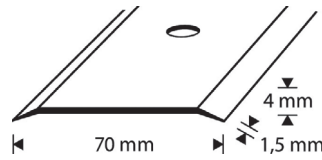

70 mm Sileä, messinki | Slät, mässing | Smooth, brass

TUOTENRO PRODUKTNR PRODUCT NO	VÄRI	FÄRG	COLOUR		PITUUS LÄNGD LENGTH	EAN-KOODI EAN-KOD EAN-CODE
7095004	Messinki	Mässing	Brass		3000	 6 417083 016844

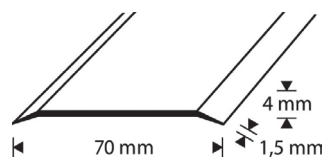

70 mm Sileä, RST | Slät, rostfritt stål | Smooth, stainless steel

TUOTENRO PRODUKTNR PRODUCT NO	VÄRI	FÄRG	COLOUR		PITUUS LÄNGD LENGTH	EAN-KOODI EAN-KOD EAN-CODE
7095005-R	RST	Rostfritt stål	Stainless steel		3000	 6 417083 950056

# SAUMALISTAT

## SKARVLISTER

### COVER STRIPS

ruuvi- tai liimakiinnityksellä  
med skruv eller lim-montering  
with screw or glue fastening

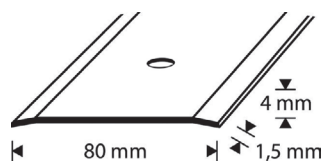

80 mm Sileä, RST | Slät, rostfritt stål | Smooth, stainless steel

TUOTENRO PRODUKTNR PRODUCT NO	VÄRI	FÄRG	COLOUR		PITUUS LÄNGD LENGTH	EAN-KOODI EAN-KOD EAN-CODE
7094805	RST	Rostfritt stål	Stainless steel		3000	 6 417 083 948 152

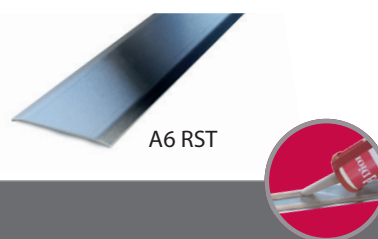
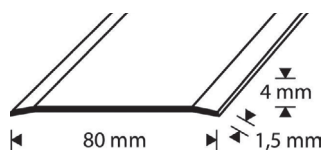

80 mm Sileä, metalli | Slät, metall | Smooth, metal

TUOTENRO PRODUKTNR PRODUCT NO	VÄRI	FÄRG	COLOUR		PITUUS LÄNGD LENGTH	EAN-KOODI EAN-KOD EAN-CODE
A6 RST 1-R	RST	Rostfritt stål	Stainless steel		1000	 6 417 083 027 741
A6 RST 2-R	RST	Rostfritt stål	Stainless steel		2000	 6 417 083 027 758
7094805-R	RST	Rostfritt stål	Stainless steel		3000	 6 417 083 910 050
7094804-R	Messinki	Mässing	Brass		3000	 6 417 083 048 043

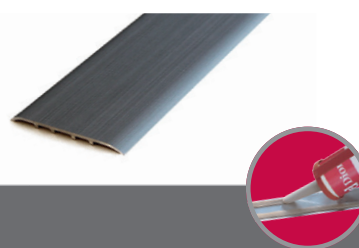
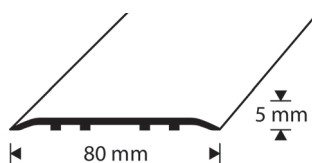

80 mm Sileä, metalliväri | Slät, metallfärg | Smooth, metal colour

TUOTENRO PRODUKTNR PRODUCT NO	VÄRI	FÄRG	COLOUR		PITUUS LÄNGD LENGTH	EAN-KOODI EAN-KOD EAN-CODE
A6 NG1-R	Nordic Graphite	Nordic Graphite	Nordic Graphite		1000	 6 417 083 026 263
A6 NG2-R	Nordic Graphite	Nordic Graphite	Nordic Graphite		2000	 6 417 083 026 256

**Nordic Graphite** -värisävy saattaa vaihdella valmistuksessa käytettävän harjaustekniikan vuoksi.  
Nyanssen **Nordic Graphite** kan variera beroende på den borstningsteknik som används vid tillverkningen.  
The **Nordic Graphite** shade may vary according to the brushing technique used in manufacturing.





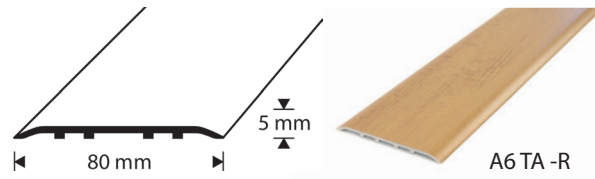







**liimakiinnityksellä**  
med lim-montering  
with glue fastening

**SAUMALISTAT**  
SKARVLISTER  
COVER STRIPS



80 mm Sileä, puukuvioitu | Slät, träimitation | Smooth, wood imitation



TUOTENRO PRODUKTNR PRODUCT NO	VÄRI	FÄRG	COLOUR		PITUUS LÄNGD LENGTH	EAN-KOODI EAN-KOD EAN-CODE
A6 PH 90-R ●	Pähkinä	Valnöt	Walnut		900	 6 4 1 7 0 8 3 8 0 1 2 9 7
A6 PH 180-R ●	Pähkinä	Valnöt	Walnut		1800	 6 4 1 7 0 8 3 8 0 1 2 1 1
A6 PH 270-R ●	Pähkinä	Valnöt	Walnut		2700	 6 4 1 7 0 8 3 9 4 8 2 0 6
A6 TA1-R	Tammi	Ek	Oak		1000	 6 4 1 7 0 8 3 0 2 9 0 3 5
A6 TA2-R	Tammi	Ek	Oak		2000	 6 4 1 7 0 8 3 0 2 9 0 1 1
A6 TA3-R	Tammi	Ek	Oak		3000	 6 4 1 7 0 8 3 0 2 9 0 2 8

- **Poistuva tuote.** Kysy lisää myynnistä
- **Utgående produkt.** Fråga mer hos försäljningen
- **Discontinued product.** Contact sales for more information

**SAUMALISTAT**  
**SKARVLISTER**  
COVER STRIPS

**liimakiinnityksellä**  
med lim-montering  
with glue fastening

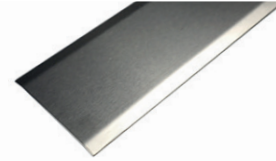
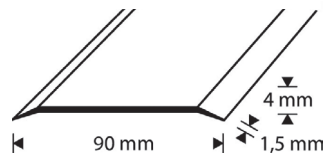

90 mm Sileä, RST | Slät, rostfritt stål | Smooth, stainless steel



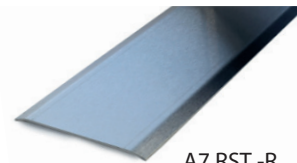
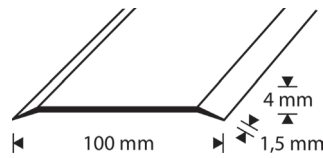





TUOTENRO PRODUKTNR PRODUCT NO	VÄRI	FÄRG	COLOUR		PITUUS LÄNGD LENGTH	EAN-KOODI EAN-KOD EAN-CODE
7095105-R	RST	Rostfritt stål	Stainless steel		3000	 6 417 083 9 510 53



A7 RST-R



100 mm Sileä, metalli | Slät, metall | Smooth, metal

TUOTENRO PRODUKTNR PRODUCT NO	VÄRI	FÄRG	COLOUR		PITUUS LÄNGD LENGTH	EAN-KOODI EAN-KOD EAN-CODE
A7 RST 1-R	RST	Rostfritt stål	Stainless steel		1000	 6 417 083 0 277 72
A7 RST 2-R	RST	Rostfritt stål	Stainless steel		2000	 6 417 083 0 277 89
7091005-R	RST	Rostfritt stål	Stainless steel		3000	 6 417 083 0 100 57
7091004-R	Messinki	Mässing	Brass		3000	 6 417 083 9 100 43

**liimakiinnityksellä**  
med lim-montering  
with glue fastening

**SAUMALISTAT**  
SKARVLISTER  
COVER STRIPS

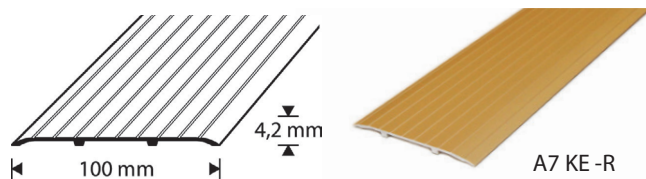

100 mm Rihlattu, metalliväri | Räfflad, metallfärg | Ridged, metal colour

TUOTENRO PRODUKTNR PRODUCT NO	VÄRI	FÄRG	COLOUR		PITUUS LÄNGD LENGTH	EAN-KOODI EAN-KOD EAN-CODE
A7 HE1-R	Hopea-anodisoitu	Silver anodiserad	Silver anodized		1000	 6 417083 022111
A7 HE2-R	Hopea-anodisoitu	Silver anodiserad	Silver anodized		2000	 6 417083 022128
A7 HE3-R	Hopea-anodisoitu	Silver anodiserad	Silver anodized		3000	 6 417083 026461
A7 KE1-R	Kulta-anodisoitu	Guld anodiserad	Gold anodized		1000	 6 417083 022098
A7 KE 180-R ●	Kulta-anodisoitu	Guld anodiserad	Gold anodized		1800	 6 417083 910135
A7 KE2-R	Kulta-anodisoitu	Guld anodiserad	Gold anodized		2000	 6 417083 022104
A7 KE3-R	Kulta-anodisoitu	Guld anodiserad	Gold anodized		3000	 6 417083 026492
A7 PE1-R	Pronssi-anodisoitu	Brons anodiserad	Bronze anodized		1000	 6 417083 026508
A7 PE2-R	Pronssi-anodisoitu	Brons anodiserad	Bronze anodized		2000	 6 417083 026515
A7 PE3-R	Pronssi-anodisoitu	Brons anodiserad	Bronze anodized		3000	 6 417083 026522

- **Poistuva tuote.** Kysy lisää myynnistä
- **Utgående produkt.** Fråga mer hos försäljningen
- **Discontinued product.** Contact sales for more information

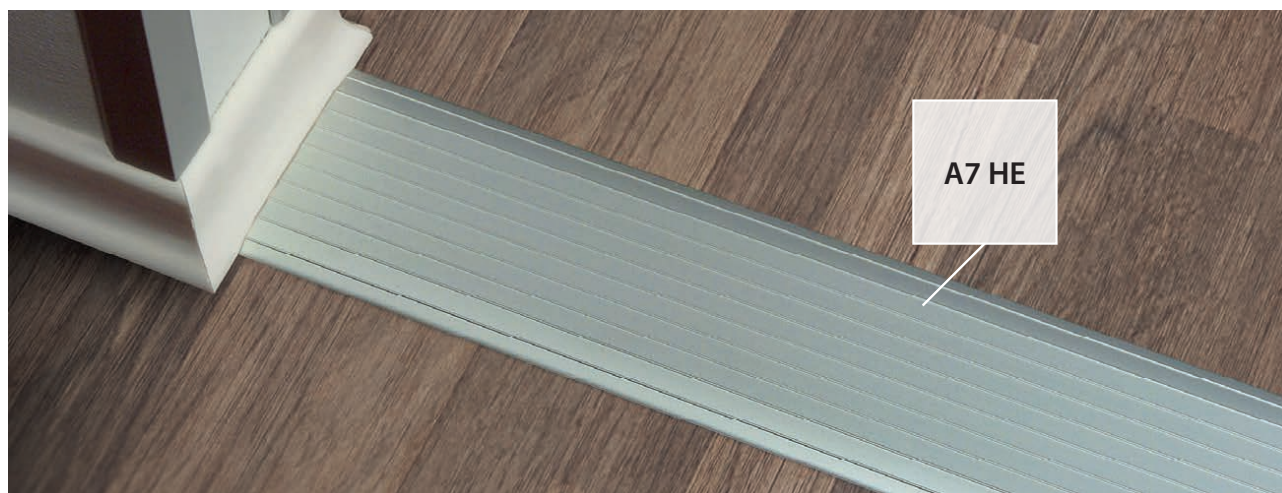

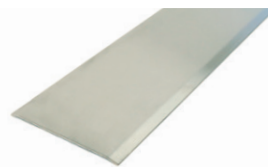
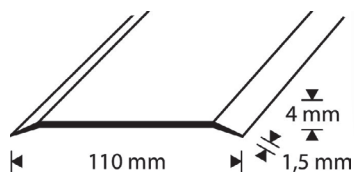
SAUMALISTAT  
SKARVLISTER  
COVER STRIPSliimakiinnityksellä  
med lim-montering  
with glue fastening

110 mm Sileä, metalli | Slät, metall | Smooth, metal



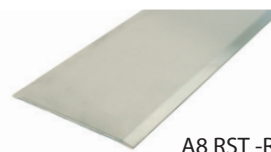
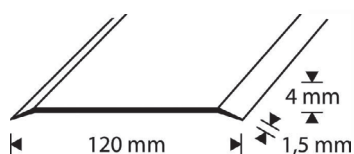





TUOTENRO PRODUKTNR PRODUCT NO	VÄRI	FÄRG	COLOUR		PITUUS LÄNGD LENGTH	EAN-KOODI EAN-KOD EAN-CODE
7091105-R	RST	Rostfritt stål	Stainless steel		3000	 6 417 083 9 110 57



A8 RST -R



120 mm Sileä, metalli | Slät, metall | Smooth, metal

TUOTENRO PRODUKTNR PRODUCT NO	VÄRI	FÄRG	COLOUR		PITUUS LÄNGD LENGTH	EAN-KOODI EAN-KOD EAN-CODE
A8 RST 1-R	RST	Rostfritt stål	Stainless steel		1000	 6 417 083 0 278 02
A8 RST 2-R	RST	Rostfritt stål	Stainless steel		2000	 6 417 083 0 278 19
70941205-R	RST	Rostfritt stål	Stainless steel		3000	 6 417 083 4 120 59
70941204-R	Messinki	Mässing	Brass		3000	 6 417 083 4 120 42

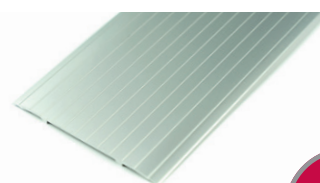
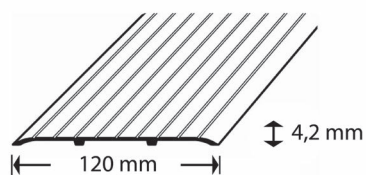

120 mm Rihlattu, metalliväri | Räfflad, metallfärg | Ridged, metal colour

TUOTENRO PRODUKTNR PRODUCT NO	VÄRI	FÄRG	COLOUR		PITUUS LÄNGD LENGTH	EAN-KOODI EAN-KOD EAN-CODE
A8 HE1-R	Hopea-anodisoitu	Silver anodiserad	Silver anodized		1000	 6 417 083 0 378 56
A8 HE2-R	Hopea-anodisoitu	Silver anodiserad	Silver anodized		2000	 6 417 083 0 378 63
A8 HE3-R	Hopea-anodisoitu	Silver anodiserad	Silver anodized		3000	 6 417 083 0 378 70

**alakiskokiinnityksellä**  
med underskena  
with underrail

**SAUMALISTAT**  
SKARVLISTER  
COVER STRIPS

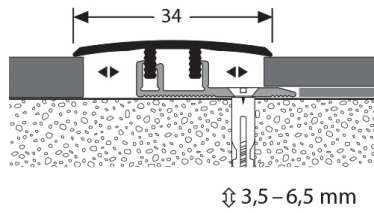

E34L ANO



34 mm / 3,5–6,5 mm Sileä, puukuviointu | Slät, träimitation | Smooth, wood imitation

TUOTENRO PRODUKTNR PRODUCT NO	VÄRI	FÄRG	COLOUR		PITUUS LÄNGD LENGTH	EAN-KOODI EAN-KOD EAN-CODE
E34L ANO 1	Aged Nordic Oak	Aged Nordic Oak	Aged Nordic Oak		1000	6 4 17083 042720
E34L ANO 2	Aged Nordic Oak	Aged Nordic Oak	Aged Nordic Oak		2000	6 4 17083 042737
E34L ANO 3	Aged Nordic Oak	Aged Nordic Oak	Aged Nordic Oak		3000	6 4 17083 042744
E34L CW 1	Cotton white	Cotton white	Cotton white		1000	6 4 17083 042904
E34L CW 2	Cotton white	Cotton white	Cotton white		2000	6 4 17083 042911
E34L CW 3	Cotton white	Cotton white	Cotton white		3000	6 4 17083 041129
E34L GRO 1	Granite Oak	Granite Oak	Granite Oak		1000	6 4 17083 042669
E34L GRO 2	Granite Oak	Granite Oak	Granite Oak		2000	6 4 17083 042676
E34L GRO 3	Granite Oak	Granite Oak	Granite Oak		3000	6 4 17083 042683
E34L KG 1	Khaki grey	Khaki grey	Khaki grey		1000	6 4 17083 042805
E34L KG 2	Khaki grey	Khaki grey	Khaki grey		2000	6 4 17083 042812
E34L KG 3	Khaki grey	Khaki grey	Khaki grey		3000	6 4 17083 042829
E34L LA 1	Valkaistu saarni	Vitkalkad ask	Limed ash		1000	6 4 17083 042928
E34L LA 2	Valkaistu saarni	Vitkalkad ask	Limed ash		2000	6 4 17083 042935
E34L LA 3	Valkaistu saarni	Vitkalkad ask	Limed ash		3000	6 4 17083 041136

JATKUU SEURAAVALLA SIVULLA  
FORTSÄTTER PÅ NÄSTA SIDA  
CONTINUED ON THE NEXT PAGE



# SAUMALISTAT

## SKARVLISTER

### COVER STRIPS

alakiskokiinnityksellä  
med underskena  
with underrail

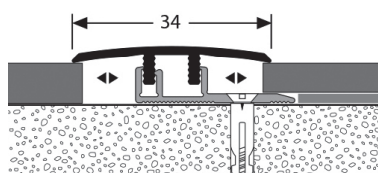

⇆ 3,5–6,5 mm



E34L NSO



← JATKOA EDELLISELTÄ SIVULTA  
FORTSÄTTER FRÅN FÖREGÅENDE SIDA  
CONTINUED FROM THE PREVIOUS PAGE

34 mm / 3,5–6,5 mm Sileä, puukuvioitu | Slät, träimitation | Smooth, wood imitation

TUOTENRO PRODUKTNR PRODUCT NO	VÄRI	FÄRG	COLOUR		PITUUS LÄNGD LENGTH	EAN-KOODI EAN-KOD EAN-CODE
E34L LO 1	Harmaa tammi	Ljus ek	Light oak		1000	6 417 083 042763
E34L LO 2	Harmaa tammi	Ljus ek	Light oak		2000	6 417 083 042776
E34L LO 3	Harmaa tammi	Ljus ek	Light oak		3000	6 417 083 041143
E34L NOA 1	Natural Oak	Natural Oak	Natural Oak		1000	6 417 083 042782
E34L NOA 2	Natural Oak	Natural Oak	Natural Oak		2000	6 417 083 042799
E34L NOA 3	Natural Oak	Natural Oak	Natural Oak		3000	6 417 083 041150
E34L NSO 1 ●	Natural Sand Oak	Natural Sand Oak	Natural Sand Oak		1000	6 417 083 042690
E34L NSO 2 ●	Natural Sand Oak	Natural Sand Oak	Natural Sand Oak		2000	6 417 083 042706
E34L NSO 3 ●	Natural Sand Oak	Natural Sand Oak	Natural Sand Oak		3000	6 417 083 042713
E34L OAK 1	Cream Oak	Cream Oak	Cream Oak		1000	6 417 083 024764
E34L OAK 2	Cream Oak	Cream Oak	Cream Oak		2000	6 417 083 024757
E34L OAK 3	Cream Oak	Cream Oak	Cream Oak		3000	6 417 083 042776
E34L TA 1	Tammi	Ek	Oak		1000	6 417 083 042942
E34L TA 2	Tammi	Ek	Oak		2000	6 417 083 042959
E34L TA 3	Tammi	Ek	Oak		3000	6 417 083 041167

- **Poistuva tuote.** Kysy lisää myynnistä
- **Utgående produkt.** Fråga mer hos försäljningen
- **Discontinued product.** Contact sales for more information

**alakiskokiinnityksellä**  
med underskena  
with underrail



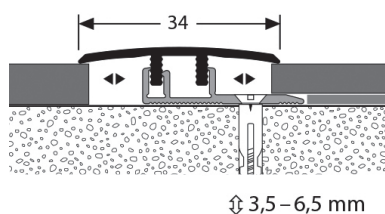













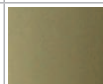

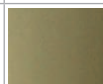

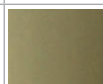



**SAUMALISTAT**  
SKARVLISTER  
COVER STRIPS

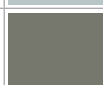

E34L NG



34 mm / 3,5–6,5 mm Sileä, metalliväri | Slät, metallfärg | Smooth, metal colour

TUOTENRO PRODUKTNR PRODUCT NO	VÄRI	FÄRG	COLOUR		PITUUS LÄNGD LENGTH	EAN-KOODI EAN-KOD EAN-CODE
E34L NG 1	Nordic Graphite	Nordic Graphite	Nordic Graphite		1000	 6 417083 042836
E34L NG 2	Nordic Graphite	Nordic Graphite	Nordic Graphite		2000	 6 417083 042843
E34L NG 3	Nordic Graphite	Nordic Graphite	Nordic Graphite		3000	 6 417083 024641
E34L SAND 1	Sand	Sand anodiserad	Sand		1000	 6 417083 024665
E34L SAND 2	Sand	Sand anodiserad	Sand		2000	 6 417083 024658
E34L SAND 3	Sand	Sand anodiserad	Sand		3000	 6 417083 024641
E34L SI 1	Hopea-anodisoitu	Silver anodiserad	Silver anodized		1000	 6 417083 024702
E34L SI 2	Hopea-anodisoitu	Silver anodiserad	Silver anodized		2000	 6 417083 024696
E34L SI 3	Hopea-anodisoitu	Silver anodiserad	Silver anodized		3000	 6 417083 024689
E34L STA 1	RST-anodisoitu	Rostfritt stål anodiserad	Stainless steel anodized		1000	 6 417083 024733
E34L STA 2	RST-anodisoitu	Rostfritt stål anodiserad	Stainless steel anodized		2000	 6 417083 024726
E34L STA 3	RST-anodisoitu	Rostfritt stål anodiserad	Stainless steel anodized		3000	 6 417083 024719

**Nordic Graphite** -värisävy saattaa vaihdella valmistuksessa käytettävän harjaustekniikan vuoksi. Nyanssen **Nordic Graphite** kan variera beroende på den borstningsteknik som används vid tillverkningen. The **Nordic Graphite** shade may vary according to the brushing technique used in manufacturing.

**SAUMALISTAT**  
**SKARVLISTER**  
COVER STRIPS

**alakiskokiinnityksellä**  
med underskena  
with underrail

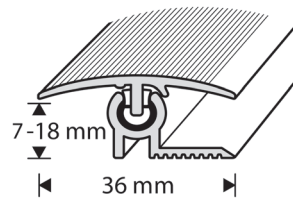

E5 HE



36 mm Rihlattu, metalliväri | Räcklad, metallfärg | Ridged, metal colour

TUOTENRO PRODUKTNR PRODUCT NO	VÄRI	FÄRG	COLOUR		PITUUS LÄNGD LENGTH	EAN-KOODI EAN-KOD EAN-CODE
E5 HE 90	Hopea-anodisoitu	Silver anodiserad	Silver anodized		900	 6 417083 016295
E5 HE 180	Hopea-anodisoitu	Silver anodiserad	Silver anodized		1800	 6 417083 016219
E5 HE 270	Hopea-anodisoitu	Silver anodiserad	Silver anodized		2700	 6 417083 016202
E5 KE 90	Kulta-anodisoitu	Guld anodiserad	Gold anodized		900	 6 417083 016394
E5 KE 180	Kulta-anodisoitu	Guld anodiserad	Gold anodized		1800	 6 417083 016318
E5 KE 270	Kulta-anodisoitu	Guld anodiserad	Gold anodized		2700	 6 417083 016301
E5 PE 90	Pronssi-anodisoitu	Brons anodiserad	Bronze anodized		900	 6 417083 901119
E5 PE 180	Pronssi-anodisoitu	Brons anodiserad	Bronze anodized		1800	 6 417083 518010
E5 PE 270	Pronssi-anodisoitu	Brons anodiserad	Bronze anodized		2700	 6 417083 527012



E5 TA

E5 NG

alakiskokiinnityksellä  
med underskena  
with underrail



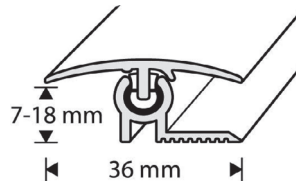









SAUMALISTAT  
SKARVLISTER  
COVER STRIPS



E5 PH

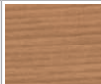

36 mm Sileä, puukuvioitu | Slät, träimitation | Smooth, wood imitation



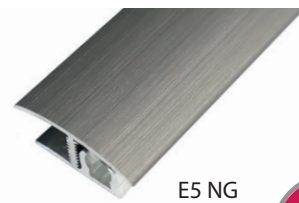
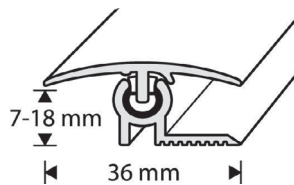



TUOTENRO PRODUKTNR PRODUCT NO	VÄRI	FÄRG	COLOUR		PITUUS LÄNGD LENGTH	EAN-KOODI EAN-KOD EAN-CODE
E5 PH 90	Pähkinä	Valnöt	Walnut		900	
E5 PH 180	Pähkinä	Valnöt	Walnut		1800	
E5 PH 270	Pähkinä	Valnöt	Walnut		2700	
E5 TA 90	Tammi	Ek	Oak		900	
E5 TA 180	Tammi	Ek	Oak		1800	
E5 TA 270	Tammi	Ek	Oak		2700	



E5 NG



36 mm Sileä, metalliväri | Slät, metallfärg | Smooth, metal colour

TUOTENRO PRODUKTNR PRODUCT NO	VÄRI	FÄRG	COLOUR		PITUUS LÄNGD LENGTH	EAN-KOODI EAN-KOD EAN-CODE
E5 NG 93	Nordic Graphite	Nordic Graphite	Nordic Graphite		930	
E5 NG 183	Nordic Graphite	Nordic Graphite	Nordic Graphite		1830	
E5 NG 282	Nordic Graphite	Nordic Graphite	Nordic Graphite		2820	

**Nordic Graphite** -värisävy saattaa vaihdella valmistuksessa käytettävän harjaustekniikan vuoksi.  
Nyanssen **Nordic Graphite** kan variera beroende på den borstningsteknik som används vid tillverkningen.  
The **Nordic Graphite** shade may vary according to the brushing technique used in manufacturing.

SAUMALISTAT  
SKARVLISTER  
COVER STRIPStulppakiinnityksellä  
med pluggmontering  
with plug fastening

K1 HE



45 mm Sileä, metalliväri | Slät, metallfärg | Smooth, metal colour

TUOTENRO PRODUKTNR PRODUCT NO	VÄRI	FÄRG	COLOUR		PITUUS LÄNGD LENGTH	EAN-KOODI EAN-KOD EAN-CODE
K1 HE 90 ●	Hopea-anodisoitu	Silver anodiserad	Silver anodized		900	 6 417 083 020728
K1 HE1	Hopea-anodisoitu	Silver anodiserad	Silver anodized		1000	 6 417 083 027499
K1 HE 180 ●	Hopea-anodisoitu	Silver anodiserad	Silver anodized		1800	 6 417 083 020704
K1 HE2	Hopea-anodisoitu	Silver anodiserad	Silver anodized		2000	 6 417 083 027505
K1 HE3	Hopea-anodisoitu	Silver anodiserad	Silver anodized		3000	 6 417 083 027512
K1 NG 90 ●	Nordic Graphite	Nordic Graphite	Nordic Graphite		900	 6 417 083 061257
K1 NG1	Nordic Graphite	Nordic Graphite	Nordic Graphite		1000	 6 417 083 027529
K1 NG 180 ●	Nordic Graphite	Nordic Graphite	Nordic Graphite		1800	 6 417 083 061233
K1 NG2	Nordic Graphite	Nordic Graphite	Nordic Graphite		2000	 6 417 083 027536
K1 NG3	Nordic Graphite	Nordic Graphite	Nordic Graphite		3000	 6 417 083 027543

- **Poistuva tuote.** Kysy lisää myynnistä
- **Utgående produkt.** Fråga mer hos försäljningen
- **Discontinued product.** Contact sales for more information

**Nordic Graphite** -värisävy saattaa vaihdella valmistuksessa käytettävän harjaustekniikan vuoksi.  
Nyansen **Nordic Graphite** kan variera beroende på den borstningsteknik som används vid tillverkningen.  
The **Nordic Graphite** shade may vary according to the brushing technique used in manufacturing.

**tulppakiinnityksellä**  
med pluggmontering  
with plug fastening

**SAUMALISTAT**  
SKARVLISTER  
COVER STRIPS



45 mm Sileä, puukuvioitu | Slät, träimitation | Smooth, wood imitation

TUOTENRO PRODUKTNR PRODUCT NO	VÄRI	FÄRG	COLOUR		PITUUS LÄNGD LENGTH	EAN-KOODI EAN-KOD EAN-CODE
K1 CW1	Cotton white	Cotton white	Cotton white		1000	6 4 17 083 030246
K1 CW2	Cotton white	Cotton white	Cotton white		2000	6 4 17 083 030222
K1 CW3	Cotton white	Cotton white	Cotton white		3000	6 4 17 083 030239
K1 KG1	Khaki grey	Khaki grey	Khaki grey		1000	6 4 17 083 030277
K1 KG2	Khaki grey	Khaki grey	Khaki grey		2000	6 4 17 083 030253
K1 KG3	Khaki grey	Khaki grey	Khaki grey		3000	6 4 17 083 030260
K1 KO 90 ●	Koivu	Björk	Birch		900	6 4 17 083 102394
K1 KO1	Koivu	Björk	Birch		1000	6 4 17 083 030307
K1 KO2	Koivu	Björk	Birch		2000	6 4 17 083 030284
K1 KO3	Koivu	Björk	Birch		3000	6 4 17 083 030291
K1 LA1	Valkaistu saarni	Vitkalkad ask	Limed ash		1000	6 4 17 083 030352
K1 LA2	Valkaistu saarni	Vitkalkad ask	Limed ash		2000	6 4 17 083 030338
K1 LA3	Valkaistu saarni	Vitkalkad ask	Limed ash		3000	6 4 17 083 030345
K1 LO1	Harmaa tammi	Ljus ek	Light oak		1000	6 4 17 083 030383
K1 LO 180 ●	Harmaa tammi	Ljus ek	Light oak		1800	6 4 17 083 200519

- **Poistuva tuote.** Kysy lisää myynnistä
- **Utgående produkt.** Fråga mer hos försäljningen
- **Discontinued product.** Contact sales for more information

JATKUU SEURAAVALLA SIVULLA  
FORTSÄTTER PÅ NÄSTA SIDA  
CONTINUED ON THE NEXT PAGE



































SAUMALISTAT  
SKARVLISTER  
COVER STRIPStulppakiinnityksellä  
med pluggmontering  
with plug fastening

 JATKOA EDELLISELTÄ SIVULTA  
FORTSÄTTER FRÅN FÖREGÅENDE SIDA  
CONTINUED FROM THE PREVIOUS PAGE

K1 NOA



45 mm Sileä, puukuvioitu | Slät, träimitation | Smooth, wood imitation

TUOTENRO PRODUKTNR PRODUCT NO	VÄRI	FÄRG	COLOUR		PITUUS LÄNGD LENGTH	EAN-KOODI EAN-KOD EAN-CODE
K1 LO2	Harmaa tammi	Ljus ek	Light oak		2000	
K1 LO3	Harmaa tammi	Ljus ek	Light oak		3000	
K1 MO1	Milky Oak	Milky Oak	Milky Oak		1000	
K1 MO2	Milky Oak	Milky Oak	Milky Oak		2000	
K1 MO3	Milky Oak	Milky Oak	Milky Oak		3000	
K1 NOA1	Natural Oak	Natural Oak	Natural Oak		1000	
K1 NOA2	Natural Oak	Natural Oak	Natural Oak		2000	
K1 NOA3	Natural Oak	Natural Oak	Natural Oak		3000	
K1 PH 90 ●	Pähkinä	Valnöt	Walnut		900	
K1 PH 180 ●	Pähkinä	Valnöt	Walnut		1800	
K1 PH 270 ●	Pähkinä	Valnöt	Walnut		2700	
K1 PY 90 ●	Pyökki	Bok	Beech		900	
K1 PY1	Pyökki	Bok	Beech		1000	
K1 PY 180 ●	Pyökki	Bok	Beech		1800	
K1 PY2	Pyökki	Bok	Beech		2000	
K1 PY3	Pyökki	Bok	Beech		3000	

- **Poistuva tuote.** Kysy lisää myynnistä
- **Utgående produkt.** Fråga mer hos försäljningen
- **Discontinued product.** Contact sales for more information

 JATKUU SEURAAVALLA SIVULLA  
FORTSÄTTER PÅ NÄSTA SIDA  
CONTINUED ON THE NEXT PAGE

**tulppakiinnityksellä**  
med pluggmontering  
with plug fastening

**SAUMALISTAT**  
SKARVLISTER  
COVER STRIPS



JATKOJA EDELLISELTÄ SIVULTA  
FORTSÄTTER FRÅN FÖREGÅENDE SIDA  
CONTINUED FROM THE PREVIOUS PAGE

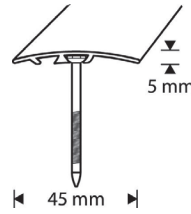

K1 ROA\*



45 mm Sileä, puukuvioitu | Slät, träimitation | Smooth, wood imitation

TUOTENRO PRODUKTNR PRODUCT NO	VÄRI	FÄRG	COLOUR		PITUUS LÄNGD LENGTH	EAN-KOODI EAN-KOD EAN-CODE
K1 ROA1*	Aito tammi	Äkta ek	Real oak		1000	6 4 17083 025877
K1 ROA2*	Aito tammi	Äkta ek	Real oak		2000	6 4 17083 025884
K1 ROA3*	Aito tammi	Äkta ek	Real oak		3000	6 4 17083 025891
K1 TA1	Tammi	Ek	Oak		1000	6 4 17083 030468
K1 TA2	Tammi	Ek	Oak		2000	6 4 17083 030451
K1 TA3	Tammi	Ek	Oak		3000	6 4 17083 102837
K1 WE1	Wenge	Wenge	Wenge		1000	6 4 17083 030499
K1 WE2	Wenge	Wenge	Wenge		2000	6 4 17083 030475
K1 WE3	Wenge	Wenge	Wenge		3000	6 4 17083 030482
K2 OA 270 ●	Tammi	Ek	Oak		2700	6 4 17083 928055

- **Poistuva tuote.** Kysy lisää myynnistä
- **Utgående produkt.** Fråga mer hos försäljningen
- **Discontinued product.** Contact sales for more information

\*) **K1 ROA** aito tammiviilu | äkta ekfaner | real oak veneer

# SAUMALISTAT SKARVLISTER COVER STRIPS

alakiskokiinnityksellä  
med underskena  
with underrail

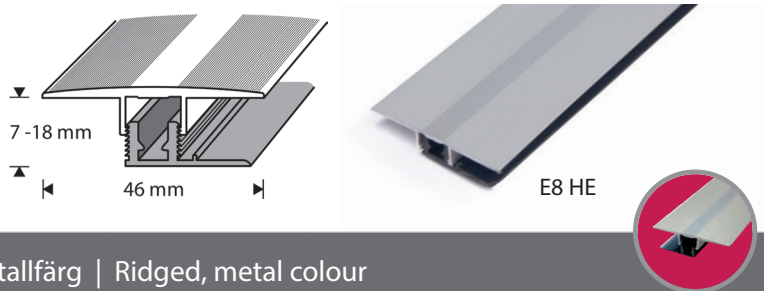

46 mm Rihlattu, metalliväri | Räfflad, metallfärg | Ridged, metal colour

TUOTENRO PRODUKTNR PRODUCT NO	VÄRI	FÄRG	COLOUR		PITUUS LÄNGD LENGTH	EAN-KOODI EAN-KOD EAN-CODE
E8 HE1	Hopea-anodisoitu	Silver anodiserad	Silver anodized		1000	6 417 083 029943
E8 HE2	Hopea-anodisoitu	Silver anodiserad	Silver anodized		2000	6 417 083 029929
E8 HE3	Hopea-anodisoitu	Silver anodiserad	Silver anodized		3000	6 417 083 029936
E8 STA1	Pronssi-anodisoitu	Brons anodiserad	Bronze anodized		1000	6 417 083 039836
E8 STA2	Pronssi-anodisoitu	Brons anodiserad	Bronze anodized		2000	6 417 083 039843
E8 STA3	Pronssi-anodisoitu	Brons anodiserad	Bronze anodized		3000	6 417 083 039850

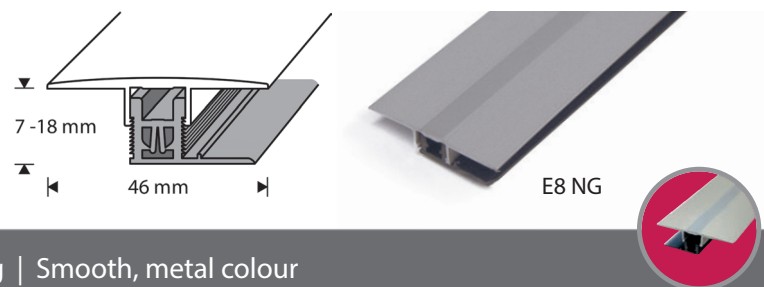

46 mm Sileä, metalliväri | Slät, metallfärg | Smooth, metal colour

TUOTENRO PRODUKTNR PRODUCT NO	VÄRI	FÄRG	COLOUR		PITUUS LÄNGD LENGTH	EAN-KOODI EAN-KOD EAN-CODE
E8 NG1	Nordic Graphite	Nordic Graphite	Nordic Graphite		1000	6 417 083 030062
E8 NG2	Nordic Graphite	Nordic Graphite	Nordic Graphite		2000	6 417 083 030048
E8 NG3	Nordic Graphite	Nordic Graphite	Nordic Graphite		3000	6 417 083 030055
E8 WH 282 ●	Maalattu valkoinen	Vitmålad	Painted white		2820	6 417 083 022869

- **Poistuva tuote.** Kysy lisää myynnistä
- **Utgående produkt.** Fråga mer hos försäljningen
- **Discontinued product.** Contact sales for more information

**Nordic Graphite** -värisävy saattaa vaihdella valmistuksessa käytettävän harjaustekniikan vuoksi. Nyansen **Nordic Graphite** kan variera beroende på den borstningsteknik som används vid tillverkningen. The **Nordic Graphite** shade may vary according to the brushing technique used in manufacturing.

**alakiskokiinnityksellä**  
med underskena  
with underrail

**SAUMALISTAT**  
SKARVLISTER  
COVER STRIPS

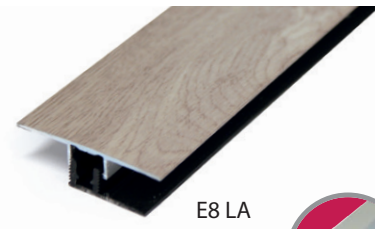
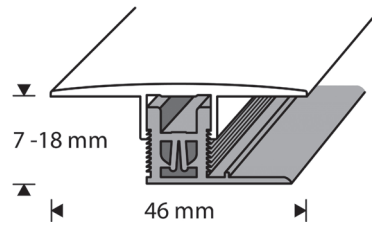

46 mm Sileä, puukuvioitu | Slät, träimitation | Smooth, wood imitation

TUOTENRO PRODUKTNR PRODUCT NO	VÄRI	FÄRG	COLOUR		PITUUS LÄNGD LENGTH	EAN-KOODI EAN-KOD EAN-CODE
E8 ANO1	Aged Nordic Oak	Aged Nordic Oak	Aged Nordic Oak		1000	
E8 ANO2	Aged Nordic Oak	Aged Nordic Oak	Aged Nordic Oak		2000	
E8 ANO3	Aged Nordic Oak	Aged Nordic Oak	Aged Nordic Oak		3000	
E8 CW1	Cotton white	Cotton white	Cotton white		1000	
E8 CW2	Cotton white	Cotton white	Cotton white		2000	
E8 CW3	Cotton white	Cotton white	Cotton white		3000	
E8 LA1	Valkaistu saarni	Vitkalkad ask	Limed ash		1000	
E8 LA2	Valkaistu saarni	Vitkalkad ask	Limed ash		2000	
E8 LA3	Valkaistu saarni	Vitkalkad ask	Limed ash		3000	
E8 LO1	Harmaa tammi	Ljus ek	Light oak		1000	
E8 LO2	Harmaa tammi	Ljus ek	Light oak		2000	
E8 LO 282 ●	Harmaa tammi	Ljus ek	Light oak		2820	
E8 LO3	Harmaa tammi	Ljus ek	Light oak		3000	

- **Poistuva tuote.** Kysy lisää myynnistä
- **Utgående produkt.** Fråga mer hos försäljningen
- **Discontinued product.** Contact sales for more information

JATKUU SEURAAVALLA SIVULLA  
FORTSÄTTER PÅ NÄSTA SIDA  
CONTINUED ON THE NEXT PAGE



# SAUMALISTAT

## SKARVLISTER

### COVER STRIPS

alakiskokiinnityksellä  
med underskena  
with underrail

JATKOA EDELLISELTÄ SIVULTA  
FORTSÄTTER FRÅN FÖREGÅENDE SIDA  
CONTINUED FROM THE PREVIOUS PAGE

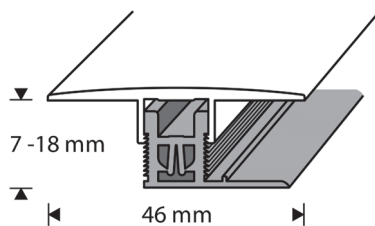

E8 ROA\*



46 mm Sileä, puukuvioitu | Slät, träimitation | Smooth, wood imitation

TUOTENRO PRODUKTNR PRODUCT NO	VÄRI	FÄRG	COLOUR		PITUUS LÄNGD LENGTH	EAN-KOODI EAN-KOD EAN-CODE
E8 MO1	Milky Oak	Milky Oak	Milky Oak		1000	
E8 MO2	Milky Oak	Milky Oak	Milky Oak		2000	
E8 MO3	Milky Oak	Milky Oak	Milky Oak		3000	
E8 NOA1	Natural Oak	Natural Oak	Natural Oak		1000	
E8 NOA2	Natural Oak	Natural Oak	Natural Oak		2000	
E8 NOA3	Natural Oak	Natural Oak	Natural Oak		3000	
E8 ROA1*	Aito tammi	Äkta ek	Real oak		1000	
E8 ROA2*	Aito tammi	Äkta ek	Real oak		2000	
E8 ROA3*	Aito tammi	Äkta ek	Real oak		3000	
E8 TA1	Tammi	Ek	Oak		1000	
E8 TA2	Tammi	Ek	Oak		2000	
E8 TA3	Tammi	Ek	Oak		3000	

\*) **E8 ROA** aito tammiviilu | äkta ekfaner | real oak veneer

**liimakiinnityksellä**  
med lim-montering  
with glue fastening

**SAUMALISTAT**  
SKARVLISTER  
COVER STRIPS

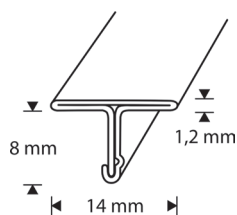

14615



14 x 8 x 1,2 mm T-lista, RST | T-profil, rostfritt stål | T-profile, stainless steel

TUOTENRO PRODUKTNR PRODUCT NO	VÄRI	FÄRG	COLOUR		PITUUS LÄNGD LENGTH	EAN-KOODI EAN-KOD EAN-CODE
14615	RST, hiottu	Rostfritt stål, borstat	Stainless steel, brushed		2500	 6 417083 040214
14625	RST, kiillotettu	Rostfritt stål, polerad	Stainless steel, polished		2500	 6 417083 018633

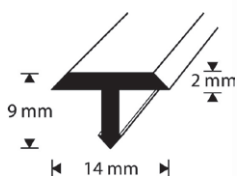

14 x 9 x 2 mm T-lista | T-profil | T-profile

TUOTENRO PRODUKTNR PRODUCT NO	VÄRI	FÄRG	COLOUR		PITUUS LÄNGD LENGTH	EAN-KOODI EAN-KOD EAN-CODE
7131402	Hopea-anodisoitu	Silver anodiserad	Silver anodized		2700	 6 417083 314025

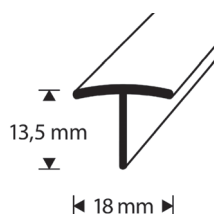

18 mm x 13,5 mm T-lista, muovi | T-profil, plast | T-profile, plastic

TUOTENRO PRODUKTNR PRODUCT NO	VÄRI	FÄRG	COLOUR		PITUUS LÄNGD LENGTH	EAN-KOODI EAN-KOD EAN-CODE
T18-410	Valkoinen	Vit	White		2700	 6 417083 042515

Katso myös **Hobby-tuotteet** sivu 232 | Se också **Hobby-produkter** på sidan 232 | See also **Hobby products** on page 232

# SAUMALISTAT

## SKARVLISTER

### COVER STRIPS



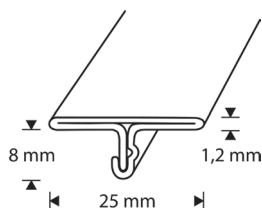

liimakiinnityksellä  
med lim-montering  
with glue fastening



14725



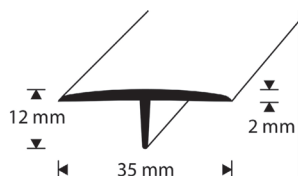

#### 25 x 8 x 1,2 mm T-lista, RST | T-profil, rostfritt stål | T-profile, stainless steel

TUOTENRO PRODUKTNR PRODUCT NO	VÄRI	FÄRG	COLOUR		PITUUS LÄNGD LENGTH	EAN-KOODI EAN-KOD EAN-CODE
14715	RST, hiottu	Rostfritt stål, borstat	Stainless steel, brushed		2500	 6 417 083 018 824
14725	RST, kiillotettu	Rostfritt stål, polerad	Stainless steel, polished		2500	 6 417 083 018 565



#### 35 x 12 x 2 mm T-lista | T-profil | T-profile

TUOTENRO PRODUKTNR PRODUCT NO	VÄRI	FÄRG	COLOUR		PITUUS LÄNGD LENGTH	EAN-KOODI EAN-KOD EAN-CODE
7091601-W	Maalattu valkoinen	Vitmålad	Painted white		2700	 6 417 083 916 076

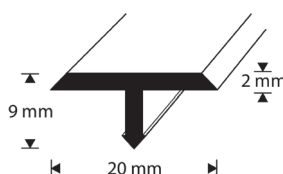



#### 20 x 9 x 2 mm T-lista | T-profil | T-profile

TUOTENRO PRODUKTNR PRODUCT NO	VÄRI	FÄRG	COLOUR		PITUUS LÄNGD LENGTH	EAN-KOODI EAN-KOD EAN-CODE
7132002	Hopea-anodisoitu	Silver anodiserad	Silver anodized		2700	 6 417 083 320 026

# liimakiinnityksellä med lim-montering with glue fastening

# FSC®-SERTIFIOIDUT T-LISTAT FSC®-CERTIFIERADE T-PROFILER I EK FSC® CERTIFIED OAK T-PROFILES







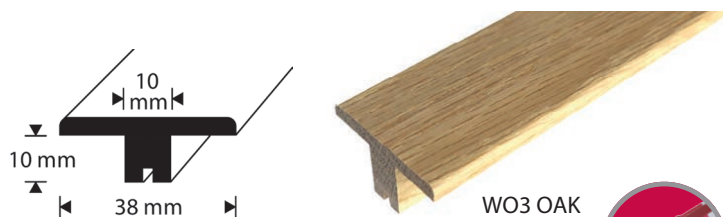

 FSC®-merkki kertoo vastuullisesti kasvatetusta ja hoidetusta metsästä. FSC®-sertifikaatti velvoittaa koko toimitusketjun kestävä metsänhoidon lisäksi myös mm. ympäristön kuormituksen minimoimiseen, eettisyyteen, ihmisoikeuksien, työolosuhteiden sekä työterveyden edistämiseen. Lisää **Dione-jalopuulistoja** löydät osioista *Eritasolistat, Päätelistat, Ovi- ja ikkunatuotteet* sekä *Laattalistat*.

 FSC®-märket anger att skogen har odlats och skötts på ett ansvarsfullt sätt. Förutom ansvarsfull skogsvård ålägger FSC®-certifikatet hela leveranskedjan att bl.a. minimera miljöbelastningen, handla på ett etiskt sätt och främja mänskliga rättigheter, arbetsmiljö och arbetshälsa. **Fler Dione-trälister** hittar du i avsnitten *Nivålistor, Avslutningslistor, Dörr- och fönsterprodukter* och *Kakellister*.

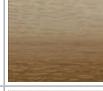
 The FSC® symbol is a sign of responsibly grown and managed forest. The FSC® certificate obliges the entire production chain to practice not only sustainable forestry but also to minimize environmental effects, follow ethical practices, respect human rights and maintain good working conditions and occupational health. You can find **more Dione hardwood trims** in the sections *Edge trims, Finishing profiles, Door and window products* and *Tile trims*.

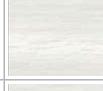

## 10 x 38 mm T-lista, lakattu tammi | T-profil, lackerad ek | T-profile, lacquered oak

TUOTENRO PRODUKTNR PRODUCT NO	VÄRI	FÄRG	COLOUR		PITUUS LÄNGD LENGTH	EAN-KOODI EAN-KOD EAN-CODE
WO3 OAK 1	Aito tammi	Äkta ek	Real oak		1000	 6 417083 103810
WO3 OAK 2	Aito tammi	Äkta ek	Real oak		2000	 6 417083 103827
WO3 WO 1 ●	Valkotammi	Vit ek	White oak		1000	 6 417083 024795
WO3 WO 2 ●	Valkotammi	Vit ek	White oak		2000	 6 417083 024801

- **Poistuva tuote.** Kysy lisää myynnistä
- **Utgående produkt.** Fråga mer hos försäljningen
- **Discontinued product.** Contact sales for more information

# FSC®-SERTIFIOIDUT T-LISTAT

## FSC®-CERTIFIERADE T-PROFILER I EK

### FSC® CERTIFIED OAK T-PROFILES

liimakiinnityksellä  
med lim-montering  
with glue fastening



The mark of  
responsible forestry

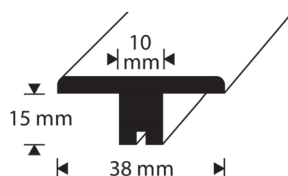

WO4 OAK

15 x 38 mm T-lista, lakattu tammi | T-profil, lackerad ek | T-profile, lacquered oak

TUOTENRO PRODUKTNR PRODUCT NO	VÄRI	FÄRG	COLOUR		PITUUS LÄNGD LENGTH	EAN-KOODI EAN-KOD EAN-CODE
WO4 OAK 1	Aito tammi	Äkta ek	Real oak		1000	6 417 083 153815
WO4 OAK 2	Aito tammi	Äkta ek	Real oak		2000	6 417 083 153822
WO4 WO 1 ●	Valkotammi	Vit ek	White oak		1000	6 417 083 024818
WO4 WO 2 ●	Valkotammi	Vit ek	White oak		2000	6 417 083 024825

- **Poistuva tuote.** Kysy lisää myynnistä
- **Utgående produkt.** Fråga mer hos försäljningen
- **Discontinued product.** Contact sales for more information

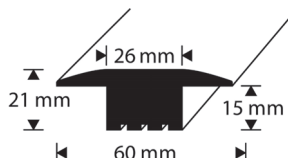

WT60 OAK

21 x 60 mm T-profil, aito puu | T-profil, äkta trä | T-profile, real wood

TUOTENRO PRODUKTNR PRODUCT NO	VÄRI	FÄRG	COLOUR		PITUUS LÄNGD LENGTH	EAN-KOODI EAN-KOD EAN-CODE
WT60 ASH 2 ●	Saarni	Ask	Ash		2000	6 417 083 191510
WT60 MA 2 ●	Valkaistu saarni	Vitkalkad ask	Limed ash		2000	6 417 083 191527
WT60 MO 2 ●	Milky Oak	Milky Oak	Milky Oak		2000	6 417 083 191428
WT60 MON 2 ●	Valkotammi	Vit ek	White oak		2000	6 417 083 191497
WT60 OAK 2	Aito tammi	Äkta ek	Real oak		2000	6 417 083 191411
WT60 WN 2 ●	Pähkinä	Valnöt	Walnut		2000	6 417 083 191435

- **Poistuva tuote.** Kysy lisää myynnistä
- **Utgående produkt.** Fråga mer hos försäljningen
- **Discontinued product.** Contact sales for more information

# ERITASOLISTAT NIVÅLISTER EDGE TRIMS

## ≡ TASOITA KORKEUSEROJA JA YHDISTÄ ERI LATTIAMATERIAALEJA.

Eritasolistoja käytetään pintojen väliin jäävien saumojen ja liikuntasaumojen viimeistelyyn. Eritasolistat ovat taloudellinen ratkaisu materiaalierojen tasoittamiseen, sillä ne tekevät lattiarakenteiden purkamisen ja uudelleen rakentamisen tarpeettomaksi. Valitse mieleinen sävy Dione-eritasolistojen laajasta väriskaalasta.

Lattiamateriaalin mukaan eritasolistat voi asentaa ruuveilla, liimalla, Elasticfix-tarrakiinnityksellä tai alakiskokiinnitteillä.

## + JÄMNA UT HÖJDSKILLNADER OCH KOMBINERA OLIKA GOLVMATERIAL.

Nivålister används för att ge en sista touch till skarvar och rörelsefogar mellan olika ytor. Nivålister är ett prisvärt sätt för utjämning av materialskillnader eftersom golvkonstruktionerna inte behöver tas isär och byggas ihop på nytt. Välj önskad färg på Dione-nivålisterna på den omfattande färgskalan.

Beroende på golvmaterialet kan nivålister monteras med skruvar, lim, självhäftande Elasticfix eller underskenor.

## 🇬🇧 JOIN FLOORING AT DIFFERENT LEVELS AND COMBINE DIFFERENT FLOORING MATERIALS.

Edge trims are used to create smooth joints and eliminate expansion gaps between surfaces that are not level. Edge trims are a cost-efficient solution for leveling out material differences as they make it unnecessary to dismantle and rebuild flooring structures. Choose your favourite from the broad range of colour options.

Depending on the flooring materials, edge trims can be installed using either screws, glue, self-adhesive Elasticfix fastening or undertrails.

**ERITASOLISTAT**  
**NIVÅLISTER**  
 EDGE TRIMS

**ruuvi- tai liimakiinnityksellä**  
 med skruv eller lim-montering  
 with screw or glue fastening

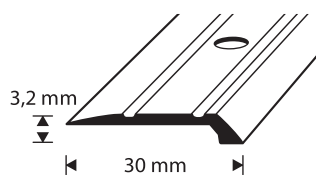

30 mm H=3,2 mm Uritettu, metalliväri | Spårad, metallfärg | Grooved, metal colour

TUOTENRO PRODUKTNR PRODUCT NO	VÄRI	FÄRG	COLOUR		PITUUS LÄNGD LENGTH	EAN-KOODI EAN-KOD EAN-CODE
C1 HE 90 ●	Hopea-anodisoitu	Silver anodiserad	Silver anodized		900	 6 417 083 311291
C1 HE1	Hopea-anodisoitu	Silver anodiserad	Silver anodized		1000	 6 417 083 311338
C1 HE 180 ●	Hopea-anodisoitu	Silver anodiserad	Silver anodized		1800	 6 417 083 311215
C1 HE2	Hopea-anodisoitu	Silver anodiserad	Silver anodized		2000	 6 417 083 311222
C1 HE3	Hopea-anodisoitu	Silver anodiserad	Silver anodized		3000	 6 417 083 030826
C1 KE1	Kulta-anodisoitu	Guld anodiserad	Gold anodized		1000	 6 417 083 311307
C1 KE 180 ●	Kulta-anodisoitu	Guld anodiserad	Gold anodized		1800	 6 417 083 311314
C1 KE2	Kulta-anodisoitu	Guld anodiserad	Gold anodized		2000	 6 417 083 311321
C1 KE 270 ●	Kulta-anodisoitu	Guld anodiserad	Gold anodized		2700	 6 417 083 921032
C1 KE3	Kulta-anodisoitu	Guld anodiserad	Gold anodized		3000	 6 417 083 030833
C1 PE 90 ●	Pronssi-anodisoitu	Brons anodiserad	Bronze anodized		900	 6 417 083 311697
C1 PE1	Pronssi-anodisoitu	Brons anodiserad	Bronze anodized		1000	 6 417 083 311604
C1 PE 180 ●	Pronssi-anodisoitu	Brons anodiserad	Bronze anodized		1800	 6 417 083 311611
C1 PE2	Pronssi-anodisoitu	Brons anodiserad	Bronze anodized		2000	 6 417 083 311628
C1 PE 270 ●	Pronssi-anodisoitu	Brons anodiserad	Bronze anodized		2700	 6 417 083 921063
C1 PE3	Pronssi-anodisoitu	Brons anodiserad	Bronze anodized		3000	 6 417 083 030840

- **Poistuva tuote.** Kysy lisää myynnistä
- **Utgående produkt.** Fråga mer hos försäljningen
- **Discontinued product.** Contact sales for more information

ruuvi- tai liimakiinnityksellä  
med skruv eller lim-montering  
with screw or glue fastening

ERITASOLISTAT  
NIVÅLISTER  
EDGE TRIMS

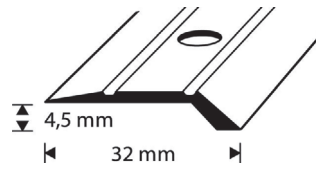

32 mm H=4,5 mm Uritettu, metalli | Spårad, metall | Grooved, metal

TUOTENRO PRODUKTNR PRODUCT NO	VÄRI	FÄRG	COLOUR		PITUUS LÄNGD LENGTH	EAN-KOODI EAN-KOD EAN-CODE
C45 KE 270 ●	Kulta-anodisoitu	Guld anodiserad	Gold anodized		2700	 6 4 17083 922039

- **Poistuva tuote.** Kysy lisää myynnistä
- **Utgående produkt.** Fråga mer hos försäljningen
- **Discontinued product.** Contact sales for more information

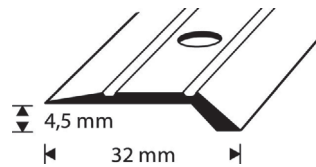

32 mm H=4,5 mm Sileä, RST | Slät, rostfritt stål | Smooth, stainless steel

TUOTENRO PRODUKTNR PRODUCT NO	VÄRI	FÄRG	COLOUR		PITUUS LÄNGD LENGTH	EAN-KOODI EAN-KOD EAN-CODE
7092201	Alumiini	Aluminium	Aluminium		2700	 6 4 17083 922015

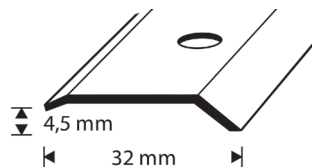

32 mm H=4,5 mm Sileä, RST | Slät, rostfritt stål | Smooth, stainless steel

TUOTENRO PRODUKTNR PRODUCT NO	VÄRI	FÄRG	COLOUR		PITUUS LÄNGD LENGTH	EAN-KOODI EAN-KOD EAN-CODE
7092205	RST	Rostfritt stål	Stainless steel		3000	 6 4 17083 922053

**ERITASOLISTAT**  
**NIVÅLISTER**  
 EDGE TRIMS

**ruuvi- tai liimakiinnityksellä**  
 med skruv eller lim-montering  
 with screw or glue fastening

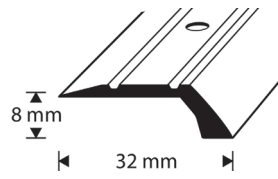

32 mm H=8 mm Uritettu, metalliväri | Spårad, metallfärg | Grooved, metal colour

TUOTENRO PRODUKTNR PRODUCT NO	VÄRI	FÄRG	COLOUR		PITUUS LÄNGD LENGTH	EAN-KOODI EAN-KOD EAN-CODE
C2 HE1	Hopea-anodisoitu	Silver anodiserad	Silver anodized		1000	
C2 HE2	Hopea-anodisoitu	Silver anodiserad	Silver anodized		2000	
C2 HE3	Hopea-anodisoitu	Silver anodiserad	Silver anodized		3000	
C2 KE1	Kulta-anodisoitu	Guld anodiserad	Gold anodized		1000	
C2 KE2	Kulta-anodisoitu	Guld anodiserad	Gold anodized		2000	
C2 KE3	Kulta-anodisoitu	Guld anodiserad	Gold anodized		3000	
C2 PE1	Pronssi-anodisoitu	Brons anodiserad	Bronze anodized		1000	
C2 PE2	Pronssi-anodisoitu	Brons anodiserad	Bronze anodized		2000	
C2 PE3	Pronssi-anodisoitu	Brons anodiserad	Bronze anodized		3000	

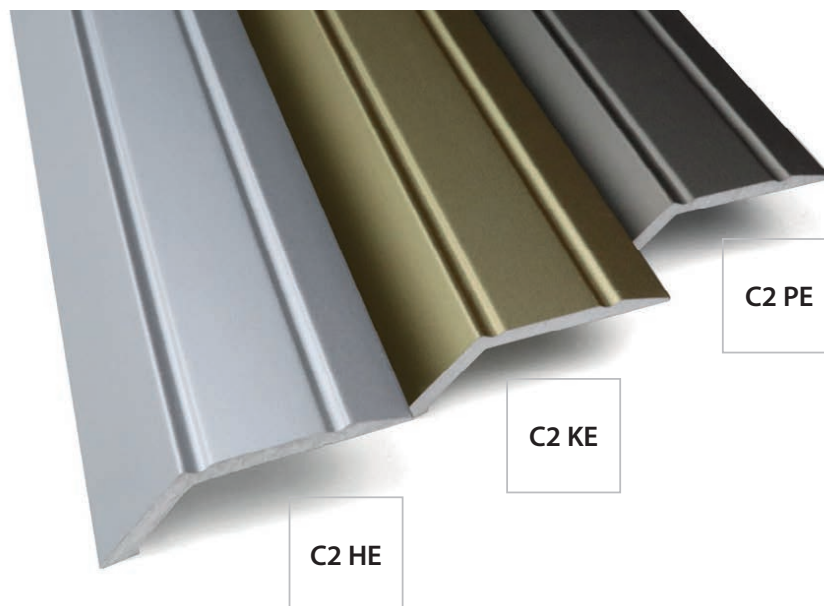

**ruuvi- tai liimakiinnityksellä**  
med skruv eller lim-montering  
with screw or glue fastening

**ERITASOLISTAT**  
NIVÅLISTER  
EDGE TRIMS

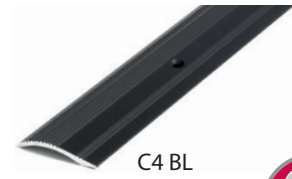
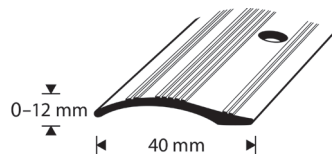

40 mm H=0–12 mm Uritettu, metalli | Spårad, metall | Grooved, metal

TUOTENRO PRODUKTNR PRODUCT NO	VÄRI	FÄRG	COLOUR		PITUUS LÄNGD LENGTH	EAN-KOODI EAN-KOD EAN-CODE
C4 BL1	Musta-anodisoitu	Svart anodiserad	Black anodized		1000	
C4 BL 180 ●	Musta-anodisoitu	Svart anodiserad	Black anodized		1800	
C4 BL2	Musta-anodisoitu	Svart anodiserad	Black anodized		2000	
C4 BL3	Musta-anodisoitu	Svart anodiserad	Black anodized		3000	
C4 HE1	Hopea-anodisoitu	Silver anodiserad	Silver anodized		1000	
C4 HE2	Hopea-anodisoitu	Silver anodiserad	Silver anodized		2000	
C4 HE3	Hopea-anodisoitu	Silver anodiserad	Silver anodized		3000	
C4 KE1	Kulta-anodisoitu	Guld anodiserad	Gold anodized		1000	
C4 KE2	Kulta-anodisoitu	Guld anodiserad	Gold anodized		2000	
C4 KE3	Kulta-anodisoitu	Guld anodiserad	Gold anodized		3000	
C4 KR1	Kromi-anodisoitu	Krom anodiserad	Chrome anodized		1000	
C4 KR 180 ●	Kromi-anodisoitu	Krom anodiserad	Chrome anodized		1800	
C4 KR2	Kromi-anodisoitu	Krom anodiserad	Chrome anodized		2000	
C4 KR3	Kromi-anodisoitu	Krom anodiserad	Chrome anodized		3000	

- **Poistuva tuote.** Kysy lisää myynnistä
- **Utgående produkt.** Fråga mer hos försäljningen
- **Discontinued product.** Contact sales for more information

JATKUU SEURAAVALLA SIVULLA  
FORTSÄTTER PÅ NÄSTA SIDA  
CONTINUED ON THE NEXT PAGE



**ERITASOLISTAT**  
**NIVÅLISTER**  
 EDGE TRIMS

**ruuvi- tai liimakiinnityksellä**  
 med skruv eller lim-montering  
 with screw or glue fastening

← JATKOA EDELLISELTÄ SIVULTA  
 FORTSÄTTER FRÅN FÖREGÅENDE SIDA  
 CONTINUED FROM THE PREVIOUS PAGE

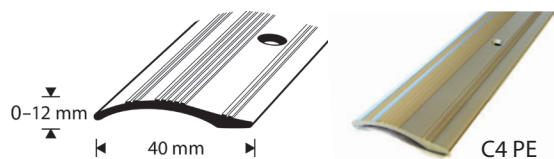

40 mm H=0-12 mm Uritettu, metalli | Spårad, metall | Grooved, metal

TUOTENRO PRODUKTNR PRODUCT NO	VÄRI	FÄRG	COLOUR		PITUUS LÄNGD LENGTH	EAN-KOODI EAN-KOD EAN-CODE
C4 PE1	Pronssi-anodisoitu	Brons anodiserad	Bronze anodized		1000	6 417 083 341601
C4 PE2	Pronssi-anodisoitu	Brons anodiserad	Bronze anodized		2000	6 417 083 341625
C4 PE3	Pronssi-anodisoitu	Brons anodiserad	Bronze anodized		3000	6 417 083 028182
7090401 ●	Alumiini, kiillotettu	Aluminium, polerad	Aluminium, polished		2700	6 417 083 904011

- **Poistuva tuote.** Kysy lisää myynnistä
- **Utgående produkt.** Fråga mer hos försäljningen
- **Discontinued product.** Contact sales for more information

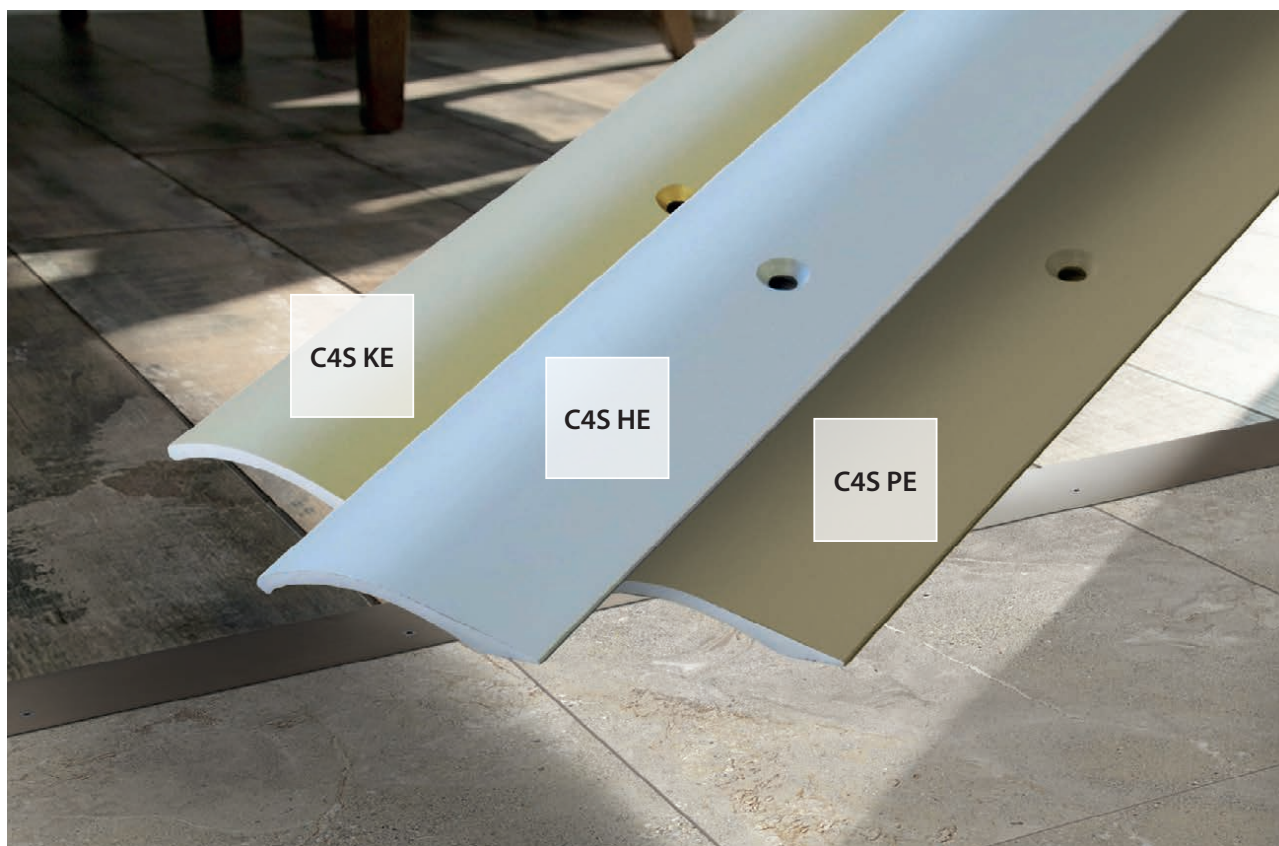

**ruuvi- tai liimakiinnityksellä**  
med skruv eller lim-montering  
with screw or glue fastening

**ERITASOLISTAT**  
NIVÅLISTER  
EDGE TRIMS

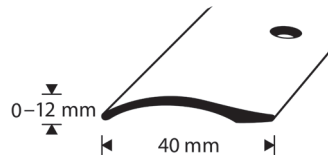

40 mm H=0–12 mm Sileä, metalli | Slät, metallfärg | Smooth, metal colour

TUOTENRO PRODUKTNR PRODUCT NO	VÄRI	FÄRG	COLOUR		PITUUS LÄNGD LENGTH	EAN-KOODI EAN-KOD EAN-CODE
C4 M 90 ●	Messinki	Mässing	Brass		900	 6 4 17083 341403
C4 M1	Messinki	Mässing	Brass		1000	 6 4 17083 026843
C4 M2	Messinki	Mässing	Brass		2000	 6 4 17083 026850
C4 M3	Messinki	Mässing	Brass		3000	 6 4 17083 026867
C4S HE 90 ●	Hopea-anodisoitu	Silver anodiserad	Silver anodized		900	 6 4 17083 018015
C4S HE1	Hopea-anodisoitu	Silver anodiserad	Silver anodized		1000	 6 4 17083 022319
C4S HE2	Hopea-anodisoitu	Silver anodiserad	Silver anodized		2000	 6 4 17083 022326
C4S HE3	Hopea-anodisoitu	Silver anodiserad	Silver anodized		3000	 6 4 17083 028199
C4S KE 90 ●	Kulta-anodisoitu	Guld anodiserad	Gold anodized		900	 6 4 17083 018046
C4S KE1	Kulta-anodisoitu	Guld anodiserad	Gold anodized		1000	 6 4 17083 022296
C4S KE 180 ●	Kulta-anodisoitu	Guld anodiserad	Gold anodized		1800	 6 4 17083 018053
C4S KE2	Kulta-anodisoitu	Guld anodiserad	Gold anodized		2000	 6 4 17083 022302
C4S KE3	Kulta-anodisoitu	Guld anodiserad	Gold anodized		3000	 6 4 17083 031250

- **Poistuva tuote.** Kysy lisää myynnistä
- **Utgående produkt.** Fråga mer hos försäljningen
- **Discontinued product.** Contact sales for more information

JATKUU SEURAAVALLA SIVULLA  
FORTSÄTTER PÅ NÄSTA SIDA  
CONTINUED ON THE NEXT PAGE



# ERITASOLISTAT NIVÅLISTER EDGE TRIMS

ruuvi- tai liimakiinnityksellä  
med skruv eller lim-montering  
with screw or glue fastening

JATKOA EDELLISELTÄ SIVULTA  
FORTSÄTTER FRÅN FÖREGÅENDE SIDA  
CONTINUED FROM THE PREVIOUS PAGE

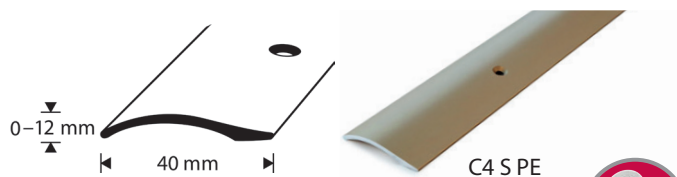



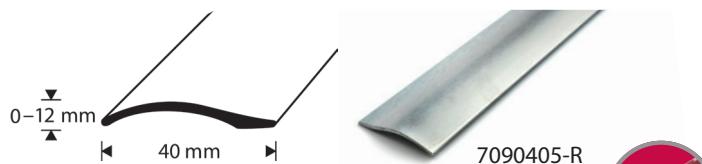

40 mm H=0–12 mm Sileä, metalli | Slät, metallfärg | Smooth, metal colour

TUOTENRO PRODUKTNR PRODUCT NO	VÄRI	FÄRG	COLOUR		PITUUS LÄNGD LENGTH	EAN-KOODI EAN-KOD EAN-CODE
C4S PE 90 ●	Pronssi-anodisoitu	Brons anodiserad	Bronze anodized		900	 6 417 083 018 077
C4S PE1	Pronssi-anodisoitu	Brons anodiserad	Bronze anodized		1000	 6 417 083 031 281
C4S PE 180 ●	Pronssi-anodisoitu	Brons anodiserad	Bronze anodized		1800	 6 417 083 018 084
C4S PE2	Pronssi-anodisoitu	Brons anodiserad	Bronze anodized		2000	 6 417 083 031 267
C4S PE3	Pronssi-anodisoitu	Brons anodiserad	Bronze anodized		3000	 6 417 083 031 274

- **Poistuva tuote.** Kysy lisää myynnistä
- **Utgående produkt.** Fråga mer hos försäljningen
- **Discontinued product.** Contact sales for more information



40 mm H=0–12 mm Sileä, metalli | Slät, metall | Smooth, metal

TUOTENRO PRODUKTNR PRODUCT NO	VÄRI	FÄRG	COLOUR		PITUUS LÄNGD LENGTH	EAN-KOODI EAN-KOD EAN-CODE
7090404-R	Messinki	Mässing	Brass		3000	 6 417 083 904 943
7090405-R	RST	Rostfritt stål	Stainless steel		3000	 6 417 083 904 059

**Elasticfix-kiinnityksellä**  
**med Elasticfix-montering**  
 with Elasticfix fastening

**ERITASOLISTAT**  
**NIVÄLISTER**  
 EDGE TRIMS

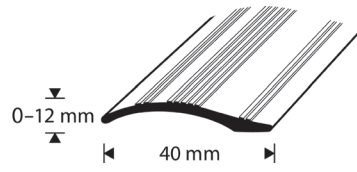

B3 HE



40 mm H=0–12 mm Rihlattu, metalli | Räckflad, metall | Ridged, metal

TUOTENRO PRODUKTNR PRODUCT NO	VÄRI	FÄRG	COLOUR		PITUUS LÄNGD LENGTH	EAN-KOODI EAN-KOD EAN-CODE
B3 HE1	Hopea-anodisoitu	Silver anodiserad	Silver anodized		1000	 6 4 17083 004209
B3 HE2	Hopea-anodisoitu	Silver anodiserad	Silver anodized		2000	 6 4 17083 004223
B3 HE3	Hopea-anodisoitu	Silver anodiserad	Silver anodized		3000	 6 4 17083 030789
B3 KE1	Kulta-anodisoitu	Guld anodiserad	Gold anodized		1000	 6 4 17083 340307
B3 KE2	Kulta-anodisoitu	Guld anodiserad	Gold anodized		2000	 6 4 17083 340321
B3 KE3	Kulta-anodisoitu	Guld anodiserad	Gold anodized		3000	 6 4 17083 030796
B3 PE1	Pronssi-anodisoitu	Brons anodiserad	Bronze anodized		1000	 6 4 17083 340604
B3 PE2	Pronssi-anodisoitu	Brons anodiserad	Bronze anodized		2000	 6 4 17083 340628
B3 PE3	Pronssi-anodisoitu	Brons anodiserad	Bronze anodized		3000	 6 4 17083 028151

**ERITASOLISTAT**  
**NIVÅLISTER**  
 EDGE TRIMS

**Elasticfix-kiinnityksellä**  
 med Elasticfix-montering  
 with Elasticfix fastening

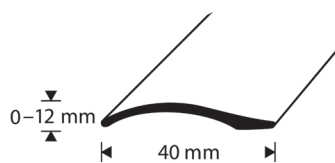

40 mm H=0-12 mm

Sileä, puukuvioitu | Slät, träimitation | Smooth, wood imitation | ELASTICFIX

TUOTENRO PRODUKTNR PRODUCT NO	VÄRI	FÄRG	COLOUR		PITUUS LÄNGD LENGTH	EAN-KOODI EAN-KOD EAN-CODE
B3 ANO1	Aged Nordic Oak	Aged Nordic Oak	Aged Nordic Oak		1000	
B3 ANO2	Aged Nordic Oak	Aged Nordic Oak	Aged Nordic Oak		2000	
B3 ANO3	Aged Nordic Oak	Aged Nordic Oak	Aged Nordic Oak		3000	
B3 CW1	Cotton white	Cotton white	Cotton white		1000	
B3 CW2	Cotton white	Cotton white	Cotton white		2000	
B3 CW3	Cotton white	Cotton white	Cotton white		3000	
B3 GRO1	Granite Oak	Granite Oak	Granite Oak		1000	
B3 GRO2	Granite Oak	Granite Oak	Granite Oak		2000	
B3 GRO3	Granite Oak	Granite Oak	Granite Oak		3000	
B3 KG1	Khaki grey	Khaki grey	Khaki grey		1000	
B3 KG2	Khaki grey	Khaki grey	Khaki grey		2000	
B3 KG3	Khaki grey	Khaki grey	Khaki grey		3000	
B3 KO1	Koivu	Björk	Birch		1000	
B3 KO2	Koivu	Björk	Birch		2000	
B3 KO3	Koivu	Björk	Birch		3000	

JATKUU SEURAAVALLA SIVULLA  
 FORTSÄTTER PÅ NÄSTA SIDA  
 CONTINUED ON THE NEXT PAGE



**Elasticfix-kiinnityksellä**  
med Elasticfix-montering  
with Elasticfix fastening

**ERITASOLISTAT**  
NIVÅLISTER  
EDGE TRIMS



JATKOA EDELLISELTÄ SIVULTA  
FORTSÄTTER FRÅN FÖREGÅENDE SIDA  
CONTINUED FROM THE PREVIOUS PAGE

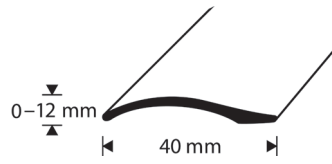

B3 NSO



40 mm H=0-12 mm

Sileä, puukuvioitu | Slät, träimitation | Smooth, wood imitation | ELASTICFIX

TUOTENRO PRODUKTNR PRODUCT NO	VÄRI	FÄRG	COLOUR		PITUUS LÄNGD LENGTH	EAN-KOODI EAN-KOD EAN-CODE
B3 LA1	Valkaistu saarni	Vitkalkad ask	Limed ash		1000	
B3 LA2	Valkaistu saarni	Vitkalkad ask	Limed ash		2000	
B3 LA3	Valkaistu saarni	Vitkalkad ask	Limed ash		3000	
B3 LO1	Harmaa tammi	Ljus ek	Light oak		1000	
B3 LO2	Harmaa tammi	Ljus ek	Light oak		2000	
B3 LO3	Harmaa tammi	Ljus ek	Light oak		3000	
B3 MO1	Milky Oak	Milky Oak	Milky Oak		1000	
B3 MO2	Milky Oak	Milky Oak	Milky Oak		2000	
B3 MO3	Milky Oak	Milky Oak	Milky Oak		3000	
B3 NOA1	Natural Oak	Natural Oak	Natural Oak		1000	
B3 NOA2	Natural Oak	Natural Oak	Natural Oak		2000	
B3 NOA3	Natural Oak	Natural Oak	Natural Oak		3000	
B3 NSO1 ●	Natural Sand Oak	Natural Sand Oak	Natural Sand Oak		1000	
B3 NSO2 ●	Natural Sand Oak	Natural Sand Oak	Natural Sand Oak		2000	
B3 NSO3 ●	Natural Sand Oak	Natural Sand Oak	Natural Sand Oak		3000	

- **Poistuva tuote.** Kysy lisää myynnistä
- **Utgående produkt.** Fråga mer hos försäljningen
- **Discontinued product.** Contact sales for more information

JATKUU SEURAAVALLA SIVULLA  
FORTSÄTTER PÅ NÄSTA SIDA  
CONTINUED ON THE NEXT PAGE



ERITASOLISTAT  
NIVÅLISTER  
EDGE TRIMS

Elasticfix-kiinnityksellä  
med Elasticfix-montering  
with Elasticfix fastening

JATKOA EDELLISELTÄ SIVULTA  
FORTSÄTTER FRÅN FÖREGÅENDE SIDA  
CONTINUED FROM THE PREVIOUS PAGE

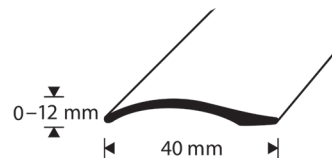

40 mm H=0-12 mm

Sileä, puukuvioitu | Slät, träimitation | Smooth, wood imitation | ELASTICFIX

TUOTENRO PRODUKTNR PRODUCT NO	VÄRI	FÄRG	COLOUR		PITUUS LÄNGD LENGTH	EAN-KOODI EAN-KOD EAN-CODE
B3 PH1	Pähkinä	Valnöt	Walnut		1000	
B3 PH2	Pähkinä	Valnöt	Walnut		2000	
B3 PH3	Pähkinä	Valnöt	Walnut		3000	
B3 PY1	Pyökki	Bok	Beech		1000	
B3 PY2	Pyökki	Bok	Beech		2000	
B3 PY 270 ●	Pyökki	Bok	Beech		2700	
B3 PY3	Pyökki	Bok	Beech		3000	
B3 ROA1*	Aito tammi	Äkta ek	Real oak		1000	
B3 ROA2*	Aito tammi	Äkta ek	Real oak		2000	
B3 ROA 270* ●	Aito tammi	Äkta ek	Real oak		2700	
B3 ROA3*	Aito tammi	Äkta ek	Real oak		3000	
B3 TA1	Tammi	Ek	Oak		1000	
B3 TA2	Tammi	Ek	Oak		2000	
B3 TA3	Tammi	Ek	Oak		3000	

\*) B3 ROA aito tammiviilu | äkta ekfaner | real oak veneer

- Poistuva tuote. Kysy lisää myynnistä
- Utgående produkt. Fråga mer hos försäljningen
- Discontinued product. Contact sales for more information

JATKUU SEURAAVALLA SIVULLA  
FORTSÄTTER PÅ NÄSTA SIDA  
CONTINUED ON THE NEXT PAGE



**Elasticfix-kiinnityksellä**  
**med Elasticfix-montering**  
 with Elasticfix fastening

**ERITASOLISTAT**  
**NIVÅLISTER**  
 EDGE TRIMS



JATKOJA EDELLISELTÄ SIVULTA  
 FORTSÄTTER FRÅN FÖREGÅENDE SIDA  
 CONTINUED FROM THE PREVIOUS PAGE

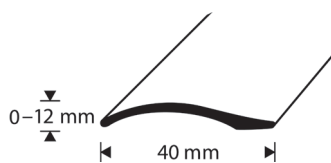







B3 WE

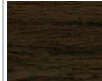

40 mm H=0-12 mm

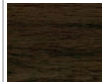
Sileä, puukuvioitu | Slät, träimitation | Smooth, wood imitation | ELASTICFIX

TUOTENRO PRODUKTNR PRODUCT NO	VÄRI	FÄRG	COLOUR		PITUUS LÄNGD LENGTH	EAN-KOODI EAN-KOD EAN-CODE
B3 WE1	Wenge	Wenge	Wenge		1000	 6 417083 029646
B3 WE2	Wenge	Wenge	Wenge		2000	 6 417083 029622
B3 WE3	Wenge	Wenge	Wenge		3000	 6 417083 029639

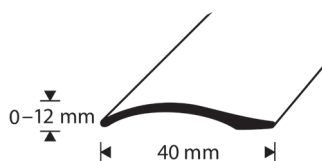











904 TA



40 mm H=0-12 mm

Sileä, puukuvioitu | Slät, träimitation | Smooth, wood imitation | ELASTICFIX

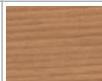
Muovi | Plast | Plastic

TUOTENRO PRODUKTNR PRODUCT NO	VÄRI	FÄRG	COLOUR		PITUUS LÄNGD LENGTH	EAN-KOODI EAN-KOD EAN-CODE
904 PH 90	Pähkinä	Valnöt	Walnut		900	 6 417083 004803
904 PH 180	Pähkinä	Valnöt	Walnut		1800	 6 417083 004810
904 PY 180	Pyökki	Bok	Beech		1800	 6 417083 004414
904 TA 90	Tammi	Ek	Oak		900	 6 417083 004308
904 TA 180	Tammi	Ek	Oak		1800	 6 417083 004315

ERITASOLISTAT  
NIVÅLISTER  
EDGE TRIMS

Elasticfix-kiinnityksellä  
med Elasticfix-montering  
with Elasticfix fastening



40 mm H=0–12 mm Sileä, metalli | Slät, metall | Smooth, metal | ELASTICFIX

TUOTENRO PRODUKTNR PRODUCT NO	VÄRI	FÄRG	COLOUR		PITUUS LÄNGD LENGTH	EAN-KOODI EAN-KOD EAN-CODE
B3 BL1	Maalattu musta	Svart målad	Painted black		1000	
B3 BL2	Maalattu musta	Svart målad	Painted black		2000	
B3 BL3	Maalattu musta	Svart målad	Painted black		3000	
B3 CBL1	Carbon black	Carbon black	Carbon black		1000	
B3 CBL2	Carbon black	Carbon black	Carbon black		2000	
B3 CBL3	Carbon black	Carbon black	Carbon black		3000	
B3 NG1	Nordic Graphite	Nordic Graphite	Nordic Graphite		1000	
B3 NG2	Nordic Graphite	Nordic Graphite	Nordic Graphite		2000	
B3 NG3	Nordic Graphite	Nordic Graphite	Nordic Graphite		3000	
B3 RST 1	RST	Rostfritt stål	Stainless steel		1000	
B3 RST 2	RST	Rostfritt stål	Stainless steel		2000	
B3 RST 3	RST	Rostfritt stål	Stainless steel		3000	
B3 WH1	Maalattu valkoinen	Vitmålad	Painted white		1000	
B3 WH2	Maalattu valkoinen	Vitmålad	Painted white		2000	
B3 WH3	Maalattu valkoinen	Vitmålad	Painted white		3000	

**Nordic Graphite** -värisävy saattaa vaihdella valmistuksessa käytettävän harjaustekniikan vuoksi. Nyansen **Nordic Graphite** kan variera beroende på den borstningsteknik som används vid tillverkningen. The **Nordic Graphite** shade may vary according to the brushing technique used in manufacturing.

JATKUU SEURAAVALLA SIVULLA  
FORTSÄTTER PÅ NÄSTA SIDA  
CONTINUED ON THE NEXT PAGE



**Elasticfix-kiinnityksellä**  
**med Elasticfix-montering**  
 with Elasticfix fastening

**ERITASOLISTAT**  
**NIVÄLISTER**  
 EDGE TRIMS



JATKOA EDELLISELTÄ SIVULTA  
 FORTSÄTTER FRÅN FÖREGÅENDE SIDA  
 CONTINUED FROM THE PREVIOUS PAGE

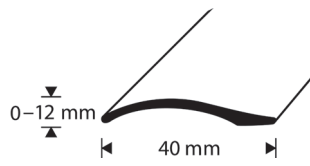

B3S HE



40 mm H=0–12 mm Sileä, metalli | Slät, metall | Smooth, metal | ELASTICFIX

TUOTENRO PRODUKTNR PRODUCT NO	VÄRI	FÄRG	COLOUR		PITUUS LÄNGD LENGTH	EAN-KOODI EAN-KOD EAN-CODE
B3S HE1	Hopea-anodisoitu	Silver anodiserad	Silver anodized		1000	 6 4 17083 022210
B3S HE2	Hopea-anodisoitu	Silver anodiserad	Silver anodized		2000	 6 4 17083 022227
B3S HE3	Hopea-anodisoitu	Silver anodiserad	Silver anodized		3000	 6 4 17083 028168
B3S KE1	Kulta-anodisoitu	Guld anodiserad	Gold anodized		1000	 6 4 17083 022197
B3S KE2	Kulta-anodisoitu	Guld anodiserad	Gold anodized		2000	 6 4 17083 022203
B3S KE3	Kulta-anodisoitu	Guld anodiserad	Gold anodized		3000	 6 4 17083 030802
B3S PE1	Pronssi-anodisoitu	Brons anodiserad	Bronze anodized		1000	 6 4 17083 022234
B3S PE2	Pronssi-anodisoitu	Brons anodiserad	Bronze anodized		2000	 6 4 17083 022241
B3S PE3	Pronssi-anodisoitu	Brons anodiserad	Bronze anodized		3000	 6 4 17083 030819

**ERITASOLISTAT**  
**NIVÅLISTER**  
**EDGE TRIMS**

**ruuvi- tai liimakiinnityksellä**  
**med skruv eller lim-montering**  
**with screw or glue fastening**

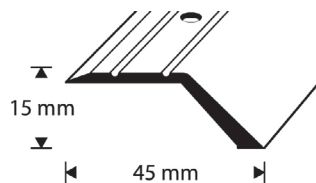

C3 HE



45 mm H=15 mm Uritettu, metalli | Spårad, metall | Grooved, metal

TUOTENRO PRODUKTNR PRODUCT NO	VÄRI	FÄRG	COLOUR		PITUUS LÄNGD LENGTH	EAN-KOODI EAN-KOD EAN-CODE
C3 HE1	Hopea-anodisoitu	Silver anodiserad	Silver anodized		1000	 6 417 083 331237
C3 HE2	Hopea-anodisoitu	Silver anodiserad	Silver anodized		2000	 6 417 083 331220
C3 HE3	Hopea-anodisoitu	Silver anodiserad	Silver anodized		3000	 6 417 083 030895
C3 KE1	Kulta-anodisoitu	Guld anodiserad	Gold anodized		1000	 6 417 083 331336
C3 KE2	Kulta-anodisoitu	Guld anodiserad	Gold anodized		2000	 6 417 083 331329
C3 KE3	Kulta-anodisoitu	Guld anodiserad	Gold anodized		3000	 6 417 083 030901
C3 PE1	Pronssi-anodisoitu	Brons anodiserad	Bronze anodized		1000	 6 417 083 331602
C3 PE2	Pronssi-anodisoitu	Brons anodiserad	Bronze anodized		2000	 6 417 083 331626
C3 PE3	Pronssi-anodisoitu	Brons anodiserad	Bronze anodized		3000	 6 417 083 030918

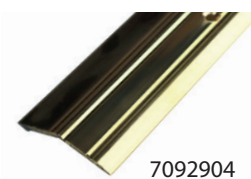
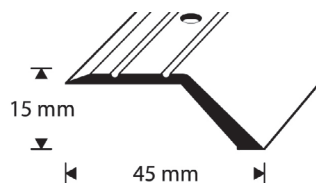

7092904



45 mm H=15 mm Uritettu, metalli | Spårad, metall | Grooved, metal

TUOTENRO PRODUKTNR PRODUCT NO	VÄRI	FÄRG	COLOUR		PITUUS LÄNGD LENGTH	EAN-KOODI EAN-KOD EAN-CODE
7092901 ●	Alumiini	Aluminium	Aluminium		2700	 6 417 083 929014
7092904	Messinki	Mässing	Brass		2700	 6 417 083 929045

● **Poistuva tuote.** Kysy lisää myynnistä / ● **Utgående produkt.** Fråga mer hos försäljningen / ● **Discontinued product.** Contact sales for more information

**ruuvi- tai liimakiinnityksellä**  
med skruv eller lim-montering  
with screw or glue fastening

**ERITASOLISTAT**  
NIVÅLISTER  
EDGE TRIMS

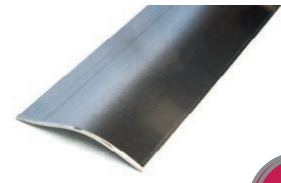
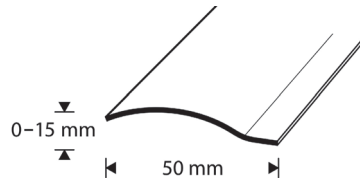

50 mm H=0–15 mm Sileä, RST | Slät, rostfritt stål | Smooth, stainless steel

TUOTENRO PRODUKTNR PRODUCT NO	VÄRI	FÄRG	COLOUR		PITUUS LÄNGD LENGTH	EAN-KOODI EAN-KOD EAN-CODE
7090905-R	RST	Rostfritt stål	Stainless steel		3000	 6 4 17083 909054

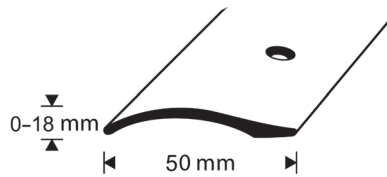

50 mm H=0–18 mm Sileä, metalli | Slät, metall | Smooth, metal

TUOTENRO PRODUKTNR PRODUCT NO	VÄRI	FÄRG	COLOUR		PITUUS LÄNGD LENGTH	EAN-KOODI EAN-KOD EAN-CODE
C7 HE 90 ●	Hopea-anodisoitu	Silver anodiserad	Silver anodized		900	 6 4 17083 020735
C7 HE1	Hopea-anodisoitu	Silver anodiserad	Silver anodized		1000	 6 4 17083 022364
C7 HE2	Hopea-anodisoitu	Silver anodiserad	Silver anodized		2000	 6 4 17083 022371
C7 HE3	Hopea-anodisoitu	Silver anodiserad	Silver anodized		3000	 6 4 17083 026317
C7 KE 90 ●	Kulta-anodisoitu	Guld anodiserad	Gold anodized		900	 6 4 17083 021251
C7 KE1	Kulta-anodisoitu	Guld anodiserad	Gold anodized		1000	 6 4 17083 022333
C7 KE 180 ●	Kulta-anodisoitu	Guld anodiserad	Gold anodized		1800	 6 4 17083 021268
C7 KE2	Kulta-anodisoitu	Guld anodiserad	Gold anodized		2000	 6 4 17083 301322
C7 KE 270 ●	Kulta-anodisoitu	Guld anodiserad	Gold anodized		2700	 6 4 17083 021275
C7 KE3	Kulta-anodisoitu	Guld anodiserad	Gold anodized		3000	 6 4 17083 028809

- **Poistuva tuote.** Kysy lisää myynnistä
- **Utgående produkt.** Fråga mer hos försäljningen
- **Discontinued product.** Contact sales for more information

JATKUU SEURAAVALLA SIVULLA  
FORTSÄTTER PÅ NÄSTA SIDA  
CONTINUED ON THE NEXT PAGE



# ERITASOLISTAT NIVÅLISTER EDGE TRIMS

ruuvi- tai liimakiinnityksellä  
med skruv eller lim-montering  
with screw or glue fastening

JATKOA EDELLISELTÄ SIVULTA  
FORTSÄTTER FRÅN FÖREGÅENDE SIDA  
CONTINUED FROM THE PREVIOUS PAGE

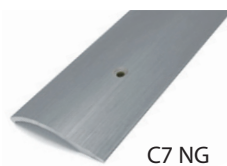
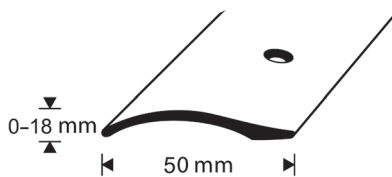

C7 NG



50 mm H=0–18 mm Sileä, metalli | Slät, metall | Smooth, metal

TUOTENRO PRODUKTNR PRODUCT NO	VÄRI	FÄRG	COLOUR		PITUUS LÄNGD LENGTH	EAN-KOODI EAN-KOD EAN-CODE
C7 NG1	Nordic Graphite	Nordic Graphite	Nordic Graphite		1000	 6 417 083 022685
C7 NG2	Nordic Graphite	Nordic Graphite	Nordic Graphite		2000	 6 417 083 022692
C7 NG3	Nordic Graphite	Nordic Graphite	Nordic Graphite		3000	 6 417 083 026898

**Nordic Graphite** -värisävy saattaa vaihdella valmistuksessa käytettävän harjaustekniikan vuoksi.  
Nyanssen **Nordic Graphite** kan variera beroende på den borstningsteknik som används vid tillverknigen.  
The **Nordic Graphite** shade may vary according to the brushing technique used in manufacturing.

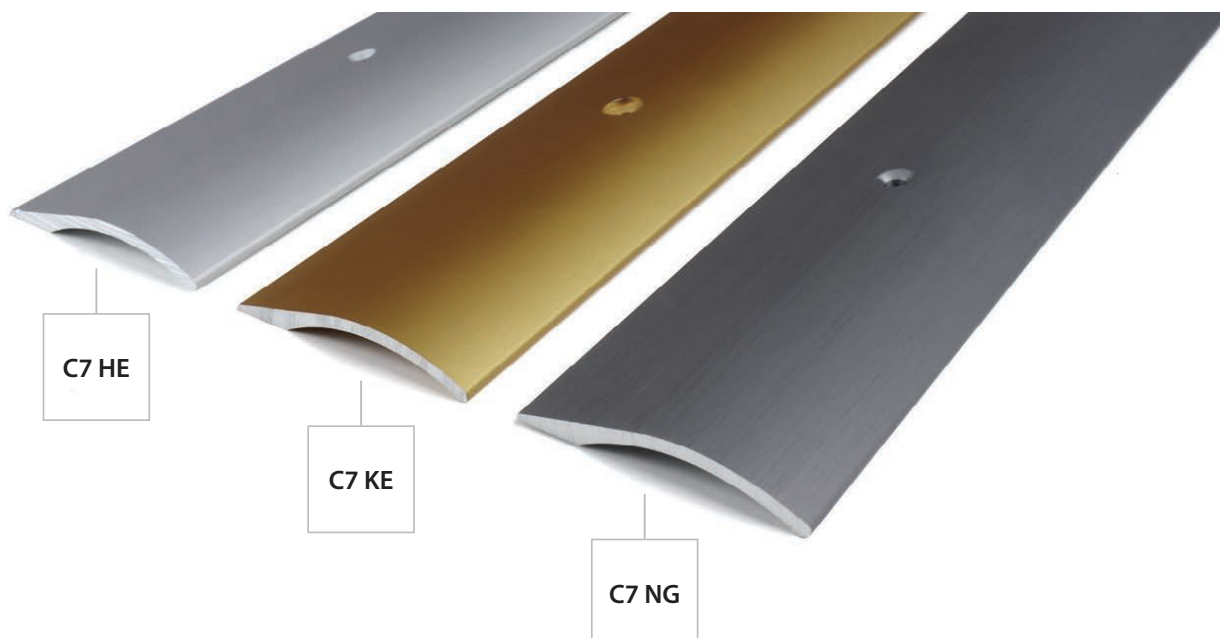

C7 HE

C7 KE

C7 NG

**Elasticfix-kiinnityksellä**  
**med Elasticfix-montering**  
 with Elasticfix fastening

**ERITASOLISTAT**  
**NIVÅLISTER**  
 EDGE TRIMS

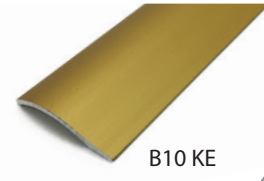

50 mm H=0–18 mm Sileä, metalli | Slät, metall | Smooth, metal | ELASTICFIX

TUOTENRO PRODUKTNR PRODUCT NO	VÄRI	FÄRG	COLOUR		PITUUS LÄNGD LENGTH	EAN-KOODI EAN-KOD EAN-CODE
B10 CBL1	Carbon black	Carbon black	Carbon black		1000	
B10 CBL2	Carbon black	Carbon black	Carbon black		2000	
B10 CBL3	Carbon black	Carbon black	Carbon black		3000	
B10 HE1	Hopea-anodisoitu	Silver anodiserad	Silver anodized		1000	
B10 HE2	Hopea-anodisoitu	Silver anodiserad	Silver anodized		2000	
B10 HE3	Hopea-anodisoitu	Silver anodiserad	Silver anodized		3000	
B10 KE1	Kulta-anodisoitu	Guld anodiserad	Gold anodized		1000	
B10 KE2	Kulta-anodisoitu	Guld anodiserad	Gold anodized		2000	
B10 KE3	Kulta-anodisoitu	Guld anodiserad	Gold anodized		3000	
B10 NG1	Nordic Graphite	Nordic Graphite	Nordic Graphite		1000	
B10 NG2	Nordic Graphite	Nordic Graphite	Nordic Graphite		2000	
B10 NG3	Nordic Graphite	Nordic Graphite	Nordic Graphite		3000	
B10 WH1	Maalattu valkoinen	Vitmålad	Painted white		1000	
B10 WH2	Maalattu valkoinen	Vitmålad	Painted white		2000	
B10 WH3	Maalattu valkoinen	Vitmålad	Painted white		3000	

**Nordic Graphite** -värisävy saattaa vaihdella valmistuksessa käytettävän harjaustekniikan vuoksi.  
 Nyansen **Nordic Graphite** kan variera beroende på den borstningsteknik som används vid tillverkningen.  
 The **Nordic Graphite** shade may vary according to the brushing technique used in manufacturing.

ERITASOLISTAT  
NIVÅLISTER  
EDGE TRIMS

Elasticfix-kiinnityksellä  
med Elasticfix-montering  
with Elasticfix fastening

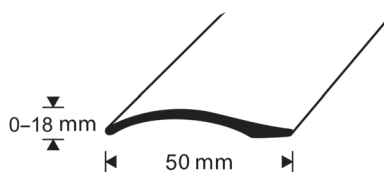

B10 MO



50 mm H=0–18 mm

Sileä, puukuvioitu | Slät, träimitation | Smooth, wood imitation | ELASTICFIX

TUOTENRO PRODUKTNR PRODUCT NO	VÄRI	FÄRG	COLOUR		PITUUS LÄNGD LENGTH	EAN-KOODI EAN-KOD EAN-CODE
B10 CW1	Cotton white	Cotton white	Cotton white		1000	
B10 CW2	Cotton white	Cotton white	Cotton white		2000	
B10 CW 270 ●	Cotton white	Cotton white	Cotton white		2700	
B10 CW3	Cotton white	Cotton white	Cotton white		3000	
B10 LO1	Harmaa tammi	Ljus ek	Light oak		1000	
B10 LO2	Harmaa tammi	Ljus ek	Light oak		2000	
B10 LO 270 ●	Harmaa tammi	Ljus ek	Light oak		2700	
B10 LO3	Harmaa tammi	Ljus ek	Light oak		3000	
B10 MO1	Milky Oak	Milky Oak	Milky Oak		1000	
B10 MO2	Milky Oak	Milky Oak	Milky Oak		2000	
B10 MO3	Milky Oak	Milky Oak	Milky Oak		3000	
B10 NOA1	Natural Oak	Natural Oak	Natural Oak		1000	
B10 NOA2	Natural Oak	Natural Oak	Natural Oak		2000	
B10 NOA3	Natural Oak	Natural Oak	Natural Oak		3000	

- **Poistuva tuote.** Kysy lisää myynnistä
- **Utgående produkt.** Fråga mer hos försäljningen
- **Discontinued product.** Contact sales for more information

JATKUU SEURAAVALLA SIVULLA  
FORTSÄTTER PÅ NÄSTA SIDA  
CONTINUED ON THE NEXT PAGE



**Elasticfix-kiinnityksellä**  
**med Elasticfix-montering**  
 with Elasticfix fastening

**ERITASOLISTAT**  
**NIVÄLISTER**  
 EDGE TRIMS



JATKOA EDELLISELTÄ SIVULTA  
 FORTSÄTTER FRÅN FÖREGÅENDE SIDA  
 CONTINUED FROM THE PREVIOUS PAGE



B10 TA



50 mm H=0–18 mm

Sileä, puukuvioitu | Slät, träimitation | Smooth, wood imitation | ELASTICFIX

TUOTENRO PRODUKTNR PRODUCT NO	VÄRI	FÄRG	COLOUR		PITUUS LÄNGD LENGTH	EAN-KOODI EAN-KOD EAN-CODE
B10 TA 90 ●	Tammi	Ek	Oak		900	 6 4 17083 023668
B10 TA1	Tammi	Ek	Oak		1000	 6 4 17083 026720
B10 TA 180 ●	Tammi	Ek	Oak		1800	 6 4 17083 023644
B10 TA2	Tammi	Ek	Oak		2000	 6 4 17083 026737
B10 TA 270 ●	Tammi	Ek	Oak		2700	 6 4 17083 023651
B10 TA3	Tammi	Ek	Oak		3000	 6 4 17083 026744

- **Poistuva tuote.** Kysy lisää myynnistä
- **Utgående produkt.** Fråga mer hos försäljningen
- **Discontinued product.** Contact sales for more information

ERITASOLISTAT  
NIVÅLISTER  
EDGE TRIMS

ruuvi- tai liimakiinnityksellä  
med skruv eller lim-montering  
with screw or glue fastening

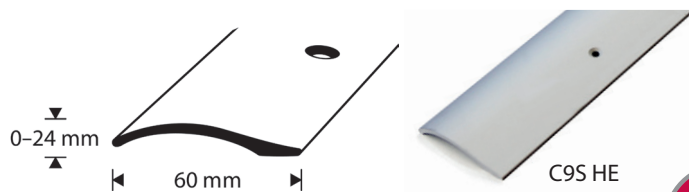

60 mm H=0–24 mm Sileä, metalli | Slät, metall | Smooth, metal

TUOTENRO PRODUKTNR PRODUCT NO	VÄRI	FÄRG	COLOUR		PITUUS LÄNGD LENGTH	EAN-KOODI EAN-KOD EAN-CODE
C9S HE1	Hopea-anodisoitu	Silver anodiserad	Silver anodized		1000	 6 417083 028229
C9S HE2	Hopea-anodisoitu	Silver anodiserad	Silver anodized		2000	 6 417083 028205
C9S HE3	Hopea-anodisoitu	Silver anodiserad	Silver anodized		3000	 6 417083 028212
C9S KE1	Kulta-anodisoitu	Guld anodiserad	Gold anodized		1000	 6 417083 028250
C9S KE2	Kulta-anodisoitu	Guld anodiserad	Gold anodized		2000	 6 417083 028236
C9S KE3	Kulta-anodisoitu	Guld anodiserad	Gold anodized		3000	 6 417083 028243
C9S KR1	Kromi-anodisoitu	Krom anodiserad	Chrome anodized		1000	 6 417083 028281
C9S KR 180 ●	Kromi-anodisoitu	Krom anodiserad	Chrome anodized		1800	 6 417083 021619
C9S KR2	Kromi-anodisoitu	Krom anodiserad	Chrome anodized		2000	 6 417083 028267
C9S KR3	Kromi-anodisoitu	Krom anodiserad	Chrome anodized		3000	 6 417083 028274
C9S PE1	Pronssi-anodisoitu	Brons anodiserad	Bronze anodized		1000	 6 417083 028311
C9S PE2	Pronssi-anodisoitu	Brons anodiserad	Bronze anodized		2000	 6 417083 028298
C9S PE3	Pronssi-anodisoitu	Brons anodiserad	Bronze anodized		3000	 6 417083 028304



- **Poistuva tuote.** Kysy lisää myynnistä
- **Utgående produkt.** Fråga mer hos försäljningen
- **Discontinued product.** Contact sales for more information

**liimakiinnityksellä**  
med lim-montering  
with glue fastening

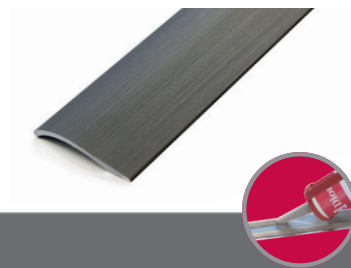
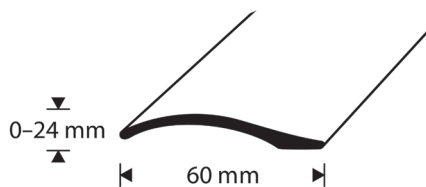
**ERITASOLISTAT**  
NIVÅLISTER  
EDGE TRIMS



60 mm H=0–24 mm Sileä, metalli | Slät, metall | Smooth, metal

TUOTENRO PRODUKTNR PRODUCT NO	VÄRI	FÄRG	COLOUR		PITUUS LÄNGD LENGTH	EAN-KOODI EAN-KOD EAN-CODE
C9 NG1-R	Nordic Graphite	Nordic Graphite	Nordic Graphite		1000	 6 4 17083 026904
C9 NG2-R	Nordic Graphite	Nordic Graphite	Nordic Graphite		2000	 6 4 17083 026911
C9 NG3-R	Nordic Graphite	Nordic Graphite	Nordic Graphite		3000	 6 4 17083 026928

**Nordic Graphite** -värisävy saattaa vaihdella valmistuksessa käytettävän harjaustekniikan vuoksi.  
Nyansen **Nordic Graphite** kan variera beroende på den borstningsteknik som används vid tillverkningen.  
The **Nordic Graphite** shade may vary according to the brushing technique used in manufacturing.



**ERITASOLISTAT**  
**NIVÅLISTER**  
 EDGE TRIMS



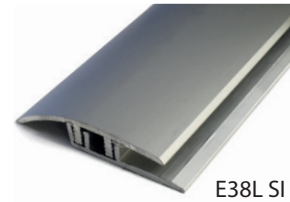
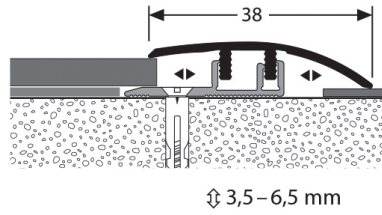















**alakiskokiinnityksellä**  
 med underskena  
 with underrail



E38L SI



38 mm H=3,5–6,5mm Sileä, metalli | Slät, metall | Smooth, metal

TUOTENRO PRODUKTNR PRODUCT NO	VÄRI	FÄRG	COLOUR		PITUUS LÄNGD LENGTH	EAN-KOODI EAN-KOD EAN-CODE
E38L SAND 1	Sand	Sand anodiserad	Sand		1000	 6 417 083 024429
E38L SAND 2	Sand	Sand anodiserad	Sand		2000	 6 417 083 024412
E38L SAND 3	Sand	Sand anodiserad	Sand		3000	 6 417 083 024405
E38L SI 1	Hopea-anodisoitu	Silver anodiserad	Silver anodized		1000	 6 417 083 024450
E38L SI 2	Hopea-anodisoitu	Silver anodiserad	Silver anodized		2000	 6 417 083 024443
E38L SI 3	Hopea-anodisoitu	Silver anodiserad	Silver anodized		3000	 6 417 083 024436
E38L STA 1	RST-anodisoitu	Rostfritt stål anodiserad	Stainless steel anodized		1000	 6 417 083 024481
E38L STA 2	RST-anodisoitu	Rostfritt stål anodiserad	Stainless steel anodized		2000	 6 417 083 024474
E38L STA 3	RST-anodisoitu	Rostfritt stål anodiserad	Stainless steel anodized		3000	 6 417 083 024467

alakiskokiinnityksellä  
med underskena  
with underrail



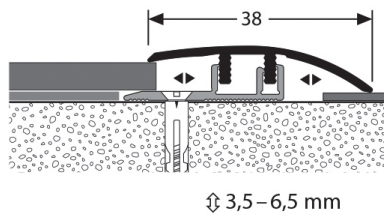













ERITASOLISTAT  
NIVÅLISTER  
EDGE TRIMS



E38L NOA



38 mm H=3,5–6,5mm Sileä, puukuvioitu | Slät, träimitation | Smooth, wood imitation

TUOTENRO PRODUKTNR PRODUCT NO	VÄRI	FÄRG	COLOUR		PITUUS LÄNGD LENGTH	EAN-KOODI EAN-KOD EAN-CODE
E38L CW 3	Cotton white	Cotton white	Cotton white		3000	 6 4 17083 040191
E38L LA 3	Valkaistu saarni	Vitkalkad ask	Limed ash		3000	 6 4 17083 040207
E38L LO 3	Harmaa tammi	Ljus ek	Light oak		3000	 6 4 17083 041044
E38L NOA 3	Natural Oak	Natural Oak	Natural Oak		3000	 6 4 17083 041051
E38L OAK 1	Cream Oak	Cream Oak	Cream Oak		1000	 6 4 17083 024511
E38L OAK 2	Cream Oak	Cream Oak	Cream Oak		2000	 6 4 17083 024504
E38L OAK 3	Cream Oak	Cream Oak	Cream Oak		3000	 6 4 17083 024498
E38L TA 3	Tammi	Ek	Oak		3000	 6 4 17083 041068

**ERITASOLISTAT**  
**NIVÄLISTER**  
 EDGE TRIMS



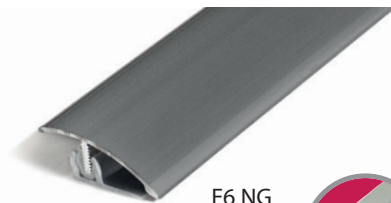
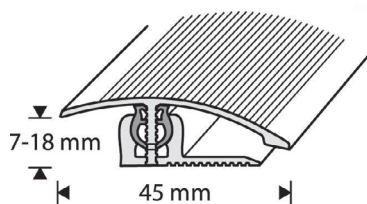











**alakiskokiinnityksellä**  
 med underskena  
 with underrail



E6 NG



45 mm H=7-18 mm Rihlattu, metalli | Räckflad, metall | Ridged, metal

TUOTENRO PRODUKTNR PRODUCT NO	VÄRI	FÄRG	COLOUR		PITUUS LÄNGD LENGTH	EAN-KOODI EAN-KOD EAN-CODE
E6 HE 90	Hopea-anodisoitu	Silver anodiserad	Silver anodized		900	 6 417 083 017 292
E6 HE 180	Hopea-anodisoitu	Silver anodiserad	Silver anodized		1800	 6 417 083 017 216
E6 HE 270	Hopea-anodisoitu	Silver anodiserad	Silver anodized		2700	 6 417 083 017 209
E6 KE 90	Kulta-anodisoitu	Guld anodiserad	Gold anodized		900	 6 417 083 017 391
E6 KE 180	Kulta-anodisoitu	Guld anodiserad	Gold anodized		1800	 6 417 083 017 315
E6 KE 270	Kulta-anodisoitu	Guld anodiserad	Gold anodized		2700	 6 417 083 017 308
E6 NG1	Nordic Graphite	Nordic Graphite	Nordic Graphite		1000	 6 417 083 043 642
E6 NG2	Nordic Graphite	Nordic Graphite	Nordic Graphite		2000	 6 417 083 043 659
E6 NG3	Nordic Graphite	Nordic Graphite	Nordic Graphite		3000	 6 417 083 043 666
E6 PE 90	Pronssi-anodisoitu	Brons anodiserad	Bronze anodized		900	 6 417 083 690 112
E6 PE 180	Pronssi-anodisoitu	Brons anodiserad	Bronze anodized		1800	 6 417 083 618 017
E6 PE 270	Pronssi-anodisoitu	Brons anodiserad	Bronze anodized		2700	 6 417 083 627 019

**Nordic Graphite** -värisävy saattaa vaihdella valmistuksessa käytettävän harjaustekniikan vuoksi.  
 Nyanssen **Nordic Graphite** kan variera beroende på den borstningsteknik som används vid tillverkningen.  
 The **Nordic Graphite** shade may vary according to the brushing technique used in manufacturing.

**alakiskokiinnityksellä**  
med underskena  
with underrail

**ERITASOLISTAT**  
NIVÅLISTER  
EDGE TRIMS

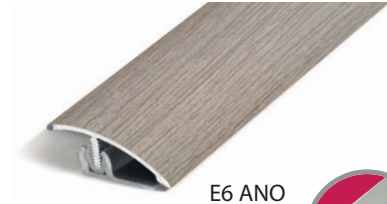
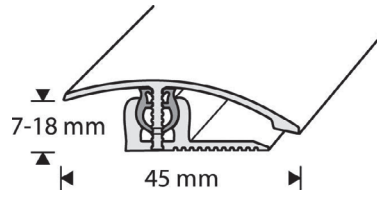

E6 ANO



45 mm H=7-18 mm Sileä, puukuvioitu | Slät, träimitation | Smooth, wood imitation

TUOTENRO PRODUKTNR PRODUCT NO	VÄRI	FÄRG	COLOUR		PITUUS LÄNGD LENGTH	EAN-KOODI EAN-KOD EAN-CODE
E6 ANO1	Aged Nordic Oak	Aged Nordic Oak	Aged Nordic Oak		1000	6 4 17083 043499
E6 ANO2	Aged Nordic Oak	Aged Nordic Oak	Aged Nordic Oak		2000	6 4 17083 043505
E6 ANO3	Aged Nordic Oak	Aged Nordic Oak	Aged Nordic Oak		3000	6 4 17083 043512
E6 CW1	Cotton white	Cotton white	Cotton white		1000	6 4 17083 043529
E6 CW2	Cotton white	Cotton white	Cotton white		2000	6 4 17083 043536
E6 CW3	Cotton white	Cotton white	Cotton white		3000	6 4 17083 043543
E6 KO 90	Koivu	Björk	Birch		900	6 4 17083 017698
E6 KO 180	Koivu	Björk	Birch		1800	6 4 17083 017612
E6 KO 270	Koivu	Björk	Birch		2700	6 4 17083 017605
E6 LA1	Valkaistu saarni	Vitkalkad ask	Limed ash		1000	6 4 17083 043550
E6 LA2	Valkaistu saarni	Vitkalkad ask	Limed ash		2000	6 4 17083 043567
E6 LA3	Valkaistu saarni	Vitkalkad ask	Limed ash		3000	6 4 17083 043574
E6 LO1	Harmaa tammi	Ljus ek	Light oak		1000	6 4 17083 043581
E6 LO2	Harmaa tammi	Ljus ek	Light oak		2000	6 4 17083 043598
E6 LO3	Harmaa tammi	Ljus ek	Light oak		3000	6 4 17083 043604

JATKUU SEURAAVALLA SIVULLA  
FORTSÄTTER PÅ NÄSTA SIDA  
CONTINUED ON THE NEXT PAGE



# ERITASOLISTAT

## NIVÅLISTER

### EDGE TRIMS

alakiskokiinnityksellä  
med underskena  
with underrail

JATKOA EDELLISELTÄ SIVULTA  
FORTSÄTTER FRÅN FÖREGÅENDE SIDA  
CONTINUED FROM THE PREVIOUS PAGE

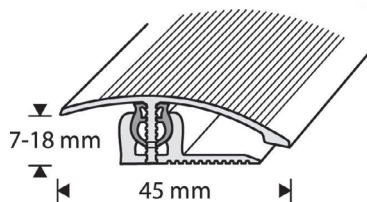

E6 MO



45 mm H=7-18 mm Sileä, puukuvioitu | Slät, träimitation | Smooth, wood imitation

TUOTENRO PRODUKTNR PRODUCT NO	VÄRI	FÄRG	COLOUR		PITUUS LÄNGD LENGTH	EAN-KOODI EAN-KOD EAN-CODE
E6 MO1	Milky Oak	Milky Oak	Milky Oak		1000	6 417 083 043611
E6 MO2	Milky Oak	Milky Oak	Milky Oak		2000	6 417 083 043628
E6 MO3	Milky Oak	Milky Oak	Milky Oak		3000	6 417 083 043635
E6 NOA1	Natural Oak	Natural Oak	Natural Oak		1000	6 417 083 043673
E6 NOA2	Natural Oak	Natural Oak	Natural Oak		2000	6 417 083 043680
E6 NOA3	Natural Oak	Natural Oak	Natural Oak		3000	6 417 083 043697
E6 PH 90 ●	Pähkinä	Valnöt	Walnut		900	6 417 083 017896
E6 PH 180 ●	Pähkinä	Valnöt	Walnut		1800	6 417 083 017810
E6 PH 270 ●	Pähkinä	Valnöt	Walnut		2700	6 417 083 017803
E6 PY 90 ●	Pyökki	Bok	Beech		900	6 417 083 017797
E6 PY 180 ●	Pyökki	Bok	Beech		1800	6 417 083 017711
E6 PY 270 ●	Pyökki	Bok	Beech		2700	6 417 083 017704
E6 ROA1*	Aito tammi	Äkta ek	Real oak		1000	6 417 083 043703
E6 ROA2*	Aito tammi	Äkta ek	Real oak		2000	6 417 083 043710
E6 ROA3*	Aito tammi	Äkta ek	Real oak		3000	6 417 083 043727

\*) E6 ROA aito tammiviilu | äkta ekfaner | real oak veneer

- Poistuva tuote. Kysy lisää myynnistä
- Utgående produkt. Fråga mer hos försäljningen
- Discontinued product. Contact sales for more information

JATKUU SEURAAVALLA SIVULLA  
FORTSÄTTER PÅ NÄSTA SIDA  
CONTINUED ON THE NEXT PAGE









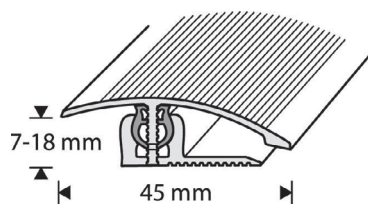

alakiskokiinnityksellä  
med underskena  
with underrail

ERITASOLISTAT  
NIVÅLISTER  
EDGE TRIMS

← JATKOA EDELLISELTÄ SIVULTA  
FORTSÄTTER FRÅN FÖREGÅENDE SIDA  
CONTINUED FROM THE PREVIOUS PAGE

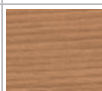

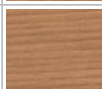
45 mm H=7-18 mm Sileä, puukuvioitu | Slät, träimitation | Smooth, wood imitation

TUOTENRO PRODUKTNR PRODUCT NO	VÄRI	FÄRG	COLOUR		PITUUS LÄNGD LENGTH	EAN-KOODI EAN-KOD EAN-CODE
E6 TA 90 ●	Tammi	Ek	Oak		900	 6 4 17083 017599
E6 TA1	Tammi	Ek	Oak		1000	 6 4 17083 029868
E6 TA2	Tammi	Ek	Oak		2000	 6 4 17083 029875
E6 TA3	Tammi	Ek	Oak		3000	 6 4 17083 029882

- **Poistuva tuote.** Kysy lisää myynnistä
- **Utgående produkt.** Fråga mer hos försäljningen
- **Discontinued product.** Contact sales for more information

FSC®-SERTIFIOIDUT ERITASOLISTAT  
 FSC®-CERTIFIERADE NIVÅLISTER I EK  
 FSC® CERTIFIED OAK EDGE TRIMS

liimakiinnityksellä  
 med lim-montering  
 with glue fastening

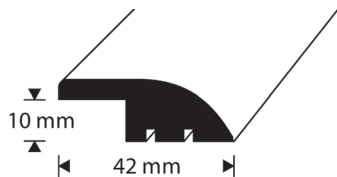

10 x 42 mm Eritasolista, lakattu tammi | Nivålist, lackerad ek | Edge trim, lacquered oak

TUOTENRO PRODUKTNR PRODUCT NO	VÄRI	FÄRG	COLOUR		PITUUS LÄNGD LENGTH	EAN-KOODI EAN-KOD EAN-CODE
WO5 OAK 1	Aito tammi	Äkta ek	Real oak		1000	6 417 083 104 213
WO5 OAK 2	Aito tammi	Äkta ek	Real oak		2000	6 417 083 104 220

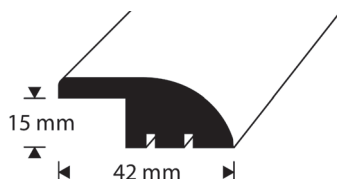

15 x 42 mm Eritasolista, lakattu tammi | Nivålist, lackerad ek | Edge trim, lacquered oak

TUOTENRO PRODUKTNR PRODUCT NO	VÄRI	FÄRG	COLOUR		PITUUS LÄNGD LENGTH	EAN-KOODI EAN-KOD EAN-CODE
WO6 OAK 1	Aito tammi	Äkta ek	Real oak		1000	6 417 083 154 218
WO6 OAK 2	Aito tammi	Äkta ek	Real oak		2000	6 417 083 154 225

# ASKELKULMALISTAT TRAPPKANTLISTER STAIR NOSINGS

## **SUOJAA KULMIA KULUMISELTA JA ESTÄ LIUKASTUMISIA.**

Askelkulmalistat soveltuvat käytettäväksi monenlaisiin askelmiin ja kynnyksiin. Ne suojaavat kulmia kulumiselta ja luovat esimerkiksi portaille huolitellun ilmeen peittämällä pintamateriaalien reunat siististi. Askelkulmalistat ovat myös tehokas keino estää liukastumisia.

Askelkulmalistat voi asentaa joko ruuveilla, liimalla tai Elasticfix-kiinnityksellä portaiden ja askelmien pintamateriaalin mukaan.

## **SKYDDAR KANTERNA MOT SLITAGE OCH MINSKAR HALKRISKEN.**

Trappkantlister passar för många olika slags trappor och trösklar. De skyddar mot slitage och ger till exempel trapporna ett prydligt utseende eftersom de täcker golvmaterialets kant på ett snyggt sätt. Trappkantlister skyddar effektivt mot halkrisk.

Trappkantlisterna kan monteras med skruvar, lim eller Elasticfix, beroende på trappans och trappstegens ytmaterial.

## **PROTECT CORNERS AND PREVENT SLIPPING.**

Stair nosings are suited for many kinds of steps and thresholds. They provide protection from wear and tear and create a tidy finish for your staircase by covering the edges of the surface material. Stair nosings are a great way to prevent slipping.

Depending on the surface material, install stair nosings with screws, glue or self-adhesive Elasticfix fastening.

**ASKELKULMALISTAT**  
TRAPPKANTLISTER  
STAIR NOSINGS

**ruuvi- tai liimakiinnityksellä**  
med skruv eller lim-montering  
with screw or glue fastening

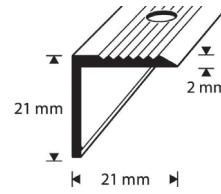

21 x 21 mm Uritettu, messinki | Spårad, mässing | Grooved, brass

TUOTENRO PRODUKTNR PRODUCT NO	VÄRI	FÄRG	COLOUR		PITUUS LÄNGD LENGTH	EAN-KOODI EAN-KOD EAN-CODE
D5 M 90 ●	Messinki	Mässing	Brass		900	6 4 1 7 0 8 3 4 6 1 4 9 1
D5 M1	Messinki	Mässing	Brass		1000	6 4 1 7 0 8 3 0 2 7 0 3 1
D5 M2	Messinki	Mässing	Brass		2000	6 4 1 7 0 8 3 4 6 1 4 2 2
D5 M3	Messinki	Mässing	Brass		3000	6 4 1 7 0 8 3 0 2 7 0 4 8

- **Poistuva tuote.** Kysy lisää myynnistä
- **Utgående produkt.** Fråga mer hos försäljningen
- **Discontinued product.** Contact sales for more information

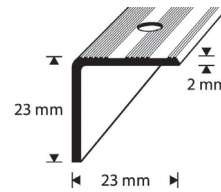

23 x 23 mm Uritettu, alumiini | Spårad, aluminium | Grooved, aluminium

TUOTENRO PRODUKTNR PRODUCT NO	VÄRI	FÄRG	COLOUR		PITUUS LÄNGD LENGTH	EAN-KOODI EAN-KOD EAN-CODE
D5 A 90 ●	Alumiini	Aluminium	Aluminium		900	6 4 1 7 0 8 3 4 6 1 1 9 4
D5 A1	Alumiini	Aluminium	Aluminium		1000	6 4 1 7 0 8 3 0 2 7 0 0 0
D5 A2	Alumiini	Aluminium	Aluminium		2000	6 4 1 7 0 8 3 0 2 7 0 1 7
D5 A3	Alumiini	Aluminium	Aluminium		3000	6 4 1 7 0 8 3 0 2 7 0 2 4

- **Poistuva tuote.** Kysy lisää myynnistä
- **Utgående produkt.** Fråga mer hos försäljningen
- **Discontinued product.** Contact sales for more information

**ruuvi- tai liimakiinnityksellä**  
**med skruv eller lim-montering**  
 with screw or glue fastening

**ASKELKULMALISTAT**  
**TRAPPKANTLISTER**  
 STAIR NOSINGS

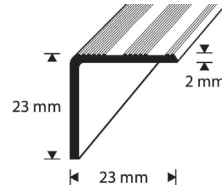

23 x 23 mm Uritettu, alumiini | Spårad, aluminium | Grooved, aluminium

TUOTENRO PRODUKTNR PRODUCT NO	VÄRI	FÄRG	COLOUR		PITUUS LÄNGD LENGTH	EAN-KOODI EAN-KOD EAN-CODE
7092601-R	Alumiini	Aluminium	Aluminium		2700	 6 4 17083 926914

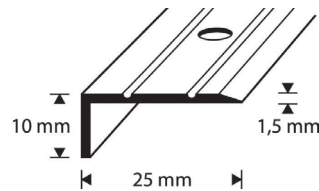

25 x 10 mm Uritettu, metalliväri | Spårad, metallfärg | Grooved, metal colour

TUOTENRO PRODUKTNR PRODUCT NO	VÄRI	FÄRG	COLOUR		PITUUS LÄNGD LENGTH	EAN-KOODI EAN-KOD EAN-CODE
D1 HE1	Hopea-anodisoitu	Silver anodiserad	Silver anodized		1000	 6 4 17083 030987
D1 HE2	Hopea-anodisoitu	Silver anodiserad	Silver anodized		2000	 6 4 17083 028328
D1 HE3	Hopea-anodisoitu	Silver anodiserad	Silver anodized		3000	 6 4 17083 030970
D1 KE1	Kulta-anodisoitu	Guld anodiserad	Gold anodized		1000	 6 4 17083 411113
D1 KE2	Kulta-anodisoitu	Guld anodiserad	Gold anodized		2000	 6 4 17083 411328
D1 KE3	Kulta-anodisoitu	Guld anodiserad	Gold anodized		3000	 6 4 17083 030994
D1 PE1	Pronssi-anodisoitu	Brons anodiserad	Bronze anodized		1000	 6 4 17083 028342
D1 PE2	Pronssi-anodisoitu	Brons anodiserad	Bronze anodized		2000	 6 4 17083 028335
D1 PE3	Pronssi-anodisoitu	Brons anodiserad	Bronze anodized		3000	 6 4 17083 031007

**ASKELKULMALISTAT**  
**TRAPPKANTLISTER**  
**STAIR NOSINGS**

**ruuvi- tai liimakiinnityksellä**  
**med skruv eller lim-montering**  
**with screw or glue fastening**

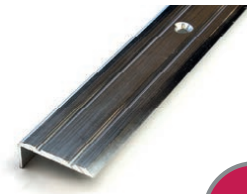
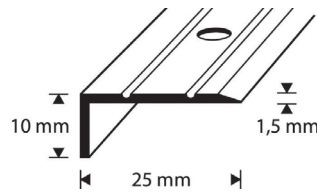

25 x 10 mm Uritettu, alumiini | Spårad, aluminium | Grooved, aluminium

TUOTENRO PRODUKTNR PRODUCT NO	VÄRI	FÄRG	COLOUR		PITUUS LÄNGD LENGTH	EAN-KOODI EAN-KOD EAN-CODE
7523601	Alumiini	Aluminium	Aluminium		2700	 6 417083 236013

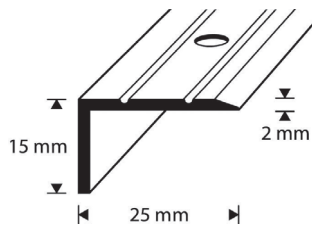

25 x 15 mm Uritettu, metalliväri | Spårad, metallfärg | Grooved, metal colour

TUOTENRO PRODUKTNR PRODUCT NO	VÄRI	FÄRG	COLOUR		PITUUS LÄNGD LENGTH	EAN-KOODI EAN-KOD EAN-CODE
D2 HE1	Hopea-anodisoitu	Silver anodiserad	Silver anodized		1000	 6 417083 421235
D2 HE2	Hopea-anodisoitu	Silver anodiserad	Silver anodized		2000	 6 417083 421228
D2 KE 90 ●	Kulta-anodisoitu	Guld anodiserad	Gold anodized		900	 6 417083 421396
D2 KE1	Kulta-anodisoitu	Guld anodiserad	Gold anodized		1000	 6 417083 421303
D2 KE2	Kulta-anodisoitu	Guld anodiserad	Gold anodized		2000	 6 417083 421327
D2 KE3	Kulta-anodisoitu	Guld anodiserad	Gold anodized		3000	 6 417083 028359
D2 M 90 ●	Messinki	Mässing	Brass		900	 6 417083 421495
D2 M1	Messinki	Mässing	Brass		1000	 6 417083 421402

JATKUU SEURAAVALLA SIVULLA  
 FORTSÄTTER PÅ NÄSTA SIDA  
 CONTINUED ON THE NEXT PAGE



**ruuvi- tai liimakiinnityksellä**  
**med skruv eller lim-montering**  
 with screw or glue fastening



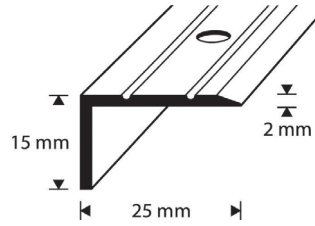





**ASKELKULMALISTAT**  
**TRAPPKANTLISTER**  
 STAIR NOSINGS



D2 M



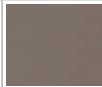

25 x 15 mm Uritettu, metalliväri | Spårad, metallfärg | Grooved, metal colour

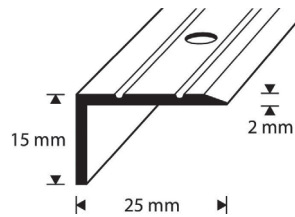
TUOTENRO PRODUKTNR PRODUCT NO	VÄRI	FÄRG	COLOUR		PITUUS LÄNGD LENGTH	EAN-KOODI EAN-KOD EAN-CODE
D2 M2	Messinki	Mässing	Brass		2000	 6 4 17083 421426
D2 M3	Messinki	Mässing	Brass		3000	 6 4 17083 026935
D2 PE1	Pronssi-anodisoitu	Brons anodiserad	Bronze anodized		1000	 6 4 17083 028373
D2 PE2	Pronssi-anodisoitu	Brons anodiserad	Bronze anodized		2000	 6 4 17083 028366



25 mm x 15 mm Uritettu, alumiini | Spårad, aluminium | Grooved, aluminium

TUOTENRO PRODUKTNR PRODUCT NO	VÄRI	FÄRG	COLOUR		PITUUS LÄNGD LENGTH	EAN-KOODI EAN-KOD EAN-CODE
7094301	Alumiini	Aluminium	Aluminium		2700	 6 4 17083 943010

**ASKELKULMALISTAT**  
**TRAPPKANTLISTER**  
**STAIR NOSINGS**

**ruuvi- tai liimakiinnityksellä**  
**med skruv eller lim-montering**  
**with screw or glue fastening**

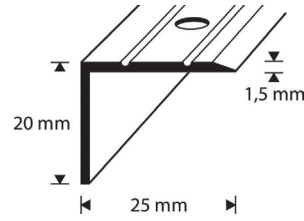

25 x 20 mm Uritettu, metalliväri | Spårad, metallfärg | Grooved, metal colour

TUOTENRO PRODUKTNR PRODUCT NO	VÄRI	FÄRG	COLOUR		PITUUS LÄNGD LENGTH	EAN-KOODI EAN-KOD EAN-CODE
D3 BL1	Musta-anodisoitu	Svart anodiserad	Black anodized		1000	 6 417 083 022821
D3 BL2	Musta-anodisoitu	Svart anodiserad	Black anodized		2000	 6 417 083 022838
D3 BL3	Musta-anodisoitu	Svart anodiserad	Black anodized		3000	 6 417 083 031014
D3 HE1	Hopea-anodisoitu	Silver anodiserad	Silver anodized		1000	 6 417 083 022388
D3 HE2	Hopea-anodisoitu	Silver anodiserad	Silver anodized		2000	 6 417 083 022395
D3 HE3	Hopea-anodisoitu	Silver anodiserad	Silver anodized		3000	 6 417 083 031021
D3 KE1	Kulta-anodisoitu	Guld anodiserad	Gold anodized		1000	 6 417 083 015120
D3 KE2	Kulta-anodisoitu	Guld anodiserad	Gold anodized		2000	 6 417 083 431326
D3 KE3	Kulta-anodisoitu	Guld anodiserad	Gold anodized		3000	 6 417 083 031038
D3 KR1	Kromi-anodisoitu	Krom anodiserad	Chrome anodized		1000	 6 417 083 026942
D3 KR2	Kromi-anodisoitu	Krom anodiserad	Chrome anodized		2000	 6 417 083 026959
D3 KR3	Kromi-anodisoitu	Krom anodiserad	Chrome anodized		3000	 6 417 083 026966
D3 PE1	Pronssi-anodisoitu	Brons anodiserad	Bronze anodized		1000	 6 417 083 022401
D3 PE2	Pronssi-anodisoitu	Brons anodiserad	Bronze anodized		2000	 6 417 083 022418
D3 PE3	Pronssi-anodisoitu	Brons anodiserad	Bronze anodized		3000	 6 417 083 031052

**ruuvi- tai liimakiinnityksellä**  
**med skruv eller lim-montering**  
 with screw or glue fastening

**ASKELKULMALISTAT**  
**TRAPPKANTLISTER**  
 STAIR NOSINGS

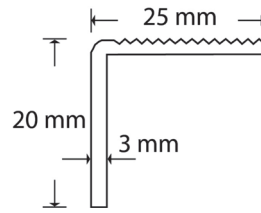

25 x 20 mm Rihlattu, RST | Räckflad, rostfritt stål | Ridged, stainless steel

TUOTENRO PRODUKTNR PRODUCT NO	VÄRI	FÄRG	COLOUR		PITUUS LÄNGD LENGTH	EAN-KOODI EAN-KOD EAN-CODE
D3 RST3	RST	Rostfritt stål	Stainless steel		3000	 6 4 17083 038655

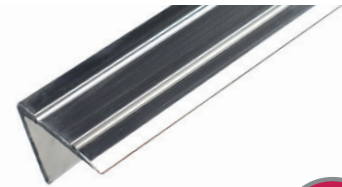
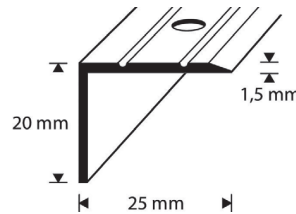

25 x 20 mm Uritettu, alumiini | Spårad, aluminium | Grooved, aluminium

TUOTENRO PRODUKTNR PRODUCT NO	VÄRI	FÄRG	COLOUR		PITUUS LÄNGD LENGTH	EAN-KOODI EAN-KOD EAN-CODE
7523501	Alumiini	Aluminium	Aluminium		3000	 6 4 17083 235016

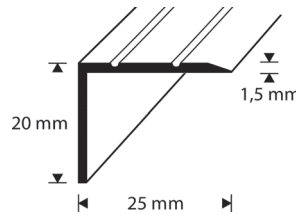

D3 NG-R



25 x 20 mm Uritettu, metalliväri | Spårad, metallfärg | Grooved, metal colour

TUOTENRO PRODUKTNR PRODUCT NO	VÄRI	FÄRG	COLOUR		PITUUS LÄNGD LENGTH	EAN-KOODI EAN-KOD EAN-CODE
D3 NG1-R	Nordic Graphite	Nordic Graphite	Nordic Graphite		1000	 6 4 17083 026324
D3 NG2-R	Nordic Graphite	Nordic Graphite	Nordic Graphite		2000	 6 4 17083 026331
7523503-R	Kulta-anodisoitu	Guld anodiserad	Gold anodized		2700	 6 4 17083 235931

**Nordic Graphite** -värisävy saattaa vaihdella valmistuksessa käytettävän harjaustekniikan vuoksi.  
 Nyansen **Nordic Graphite** kan variera beroende på den borstningsteknik som används vid tillverkningen.  
 The **Nordic Graphite** shade may vary according to the brushing technique used in manufacturing.

**ASKELKULMALISTAT**  
**TRAPPKANTLISTER**  
**STAIR NOSINGS**

**teippikiinnityksellä**  
**med tejpmontering**  
**with tape fastening**

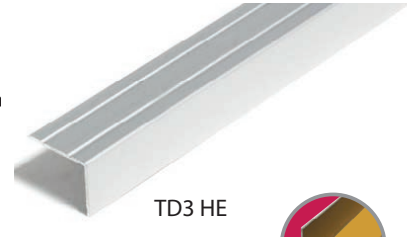
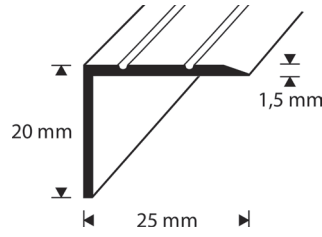

25 x 20 mm Uritettu, metalliväri | Spårad, metallfärg | Grooved, metal colour

TUOTENRO PRODUKTI PRODUCT NO	VÄRI	FÄRG	COLOUR		PITUUS LÄNGD LENGTH	EAN-KOODI EAN-KOD EAN-CODE
TD3 HE1	Hopea-anodisoitu	Silver anodiserad	Silver anodized		1000	
TD3 HE2	Hopea-anodisoitu	Silver anodiserad	Silver anodized		2000	
TD3 HE3	Hopea-anodisoitu	Silver anodiserad	Silver anodized		3000	
TD3 NG1	Nordic Graphite	Nordic Graphite	Nordic Graphite		1000	
TD3 NG2	Nordic Graphite	Nordic Graphite	Nordic Graphite		2000	
TD3 NG3	Nordic Graphite	Nordic Graphite	Nordic Graphite		3000	

**Nordic Graphite** -värisävy saattaa vaihdella valmistuksessa käytettävän harjaustekniikan vuoksi.  
 Nyansen **Nordic Graphite** kan variera beroende på den borstningsteknik som används vid tillverkningen.  
 The **Nordic Graphite** shade may vary according to the brushing technique used in manufacturing.

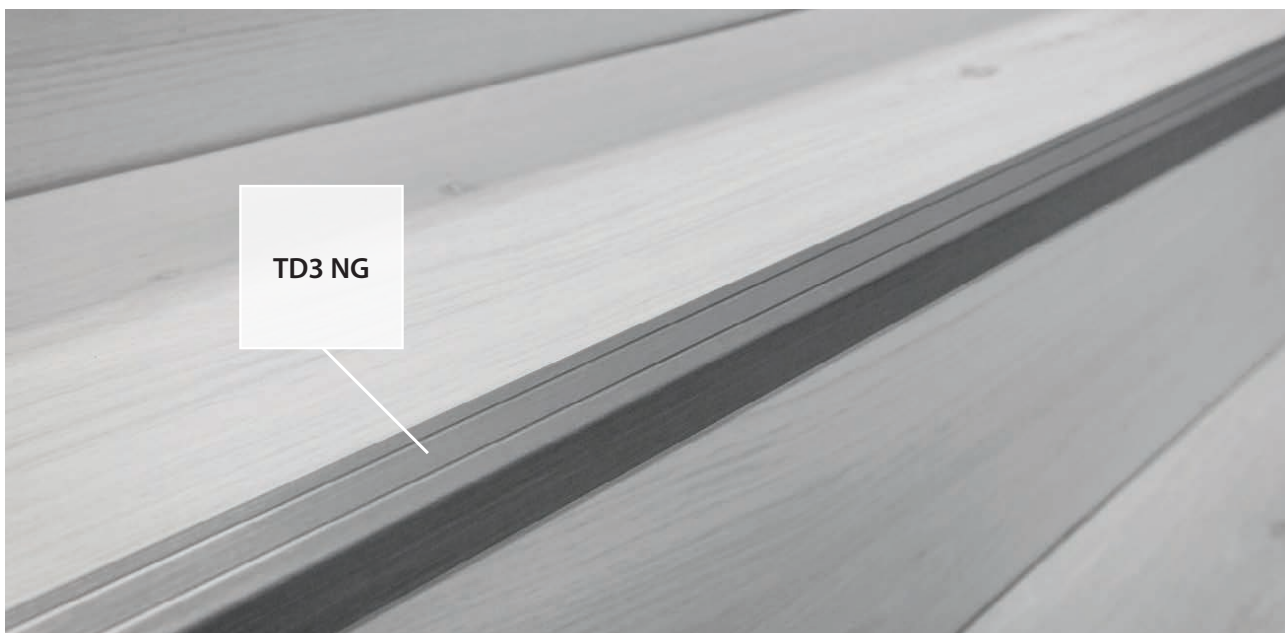

TD3 NG

**teippikiinnityksellä**  
med tejpmontering  
with tape fastening

**ASKELKULMALISTAT**  
TRAPPKANTLISTER  
STAIR NOSINGS

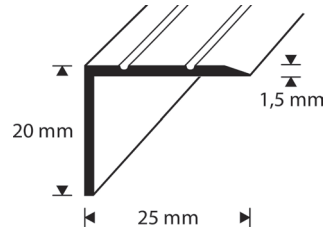

25 x 20 mm Uritettu, puukuviointu | Spårad, träimitation | Grooved, wood imitation

TUOTENRO PRODUKTNR PRODUCT NO	VÄRI	FÄRG	COLOUR		PITUUS LÄNGD LENGTH	EAN-KOODI EAN-KOD EAN-CODE
TD3 CW1	Cotton white	Cotton white	Cotton white		1000	
TD3 CW 180 ●	Cotton white	Cotton white	Cotton white		1800	
TD3 CW2	Cotton white	Cotton white	Cotton white		2000	
TD3 CW 270 ●	Cotton white	Cotton white	Cotton white		2700	
TD3 CW3	Cotton white	Cotton white	Cotton white		3000	
TD3 LO1	Harmaa tammi	Ljus ek	Light oak		1000	
TD3 LO2	Harmaa tammi	Ljus ek	Light oak		2000	
TD3 LO 270 ●	Harmaa tammi	Ljus ek	Light oak		2700	
TD3 LO3	Harmaa tammi	Ljus ek	Light oak		3000	
TD3 MO1	Milky Oak	Milky Oak	Milky Oak		1000	
TD3 MO2	Milky Oak	Milky Oak	Milky Oak		2000	
TD3 MO3	Milky Oak	Milky Oak	Milky Oak		3000	
TD3 NOA1	Natural Oak	Natural Oak	Natural Oak		1000	
TD3 NOA2	Natural Oak	Natural Oak	Natural Oak		2000	
TD3 NOA3	Natural Oak	Natural Oak	Natural Oak		3000	

- **Poistuva tuote.** Kysy lisää myynnistä
- **Utgående produkt.** Fråga mer hos försäljningen
- **Discontinued product.** Contact sales for more information

JATKUU SEURAAVALLA SIVULLA  
FORTSÄTTER PÅ NÄSTA SIDA  
CONTINUED ON THE NEXT PAGE



**ASKELKULMALISTAT**  
**TRAPPKANTLISTER**  
 STAIR NOSINGS



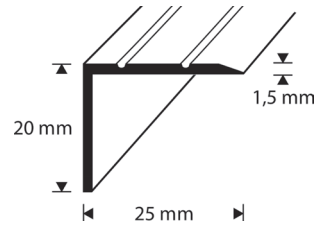



**teippi- tai liimakiinnityksellä**  
 med tejp eller lim-montering  
 with tape or glue fastening



TD3 TA



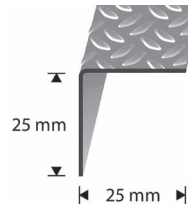

← JATKOA EDELLISELTÄ SIVULTA  
 FORTSÄTTER FRÅN FÖREGÅENDE SIDA  
 CONTINUED FROM THE PREVIOUS PAGE

25 x 20 mm Uritettu, puukuvioitu | Spårad, träimitation | Grooved, wood imitation

TUOTENRO PRODUKTNR PRODUCT NO	VÄRI	FÄRG	COLOUR		PITUUS LÄNGD LENGTH	EAN-KOODI EAN-KOD EAN-CODE
TD3 TA1	Tammi	Ek	Oak		1000	 6 417083 027628
TD3 TA2	Tammi	Ek	Oak		2000	 6 417083 027635
TD3 TA3	Tammi	Ek	Oak		3000	 6 417083 027642



25 x 25 mm Jyväalu | Durkplåt mini | Grain surface

TUOTENRO PRODUKTNR PRODUCT NO	VÄRI	FÄRG	COLOUR		PITUUS LÄNGD LENGTH	EAN-KOODI EAN-KOD EAN-CODE
D11 JVA1	Alumiini	Aluminium	Aluminium		1000	 6 417083 017834
D11 JVA2	Alumiini	Aluminium	Aluminium		2000	 6 417083 017841

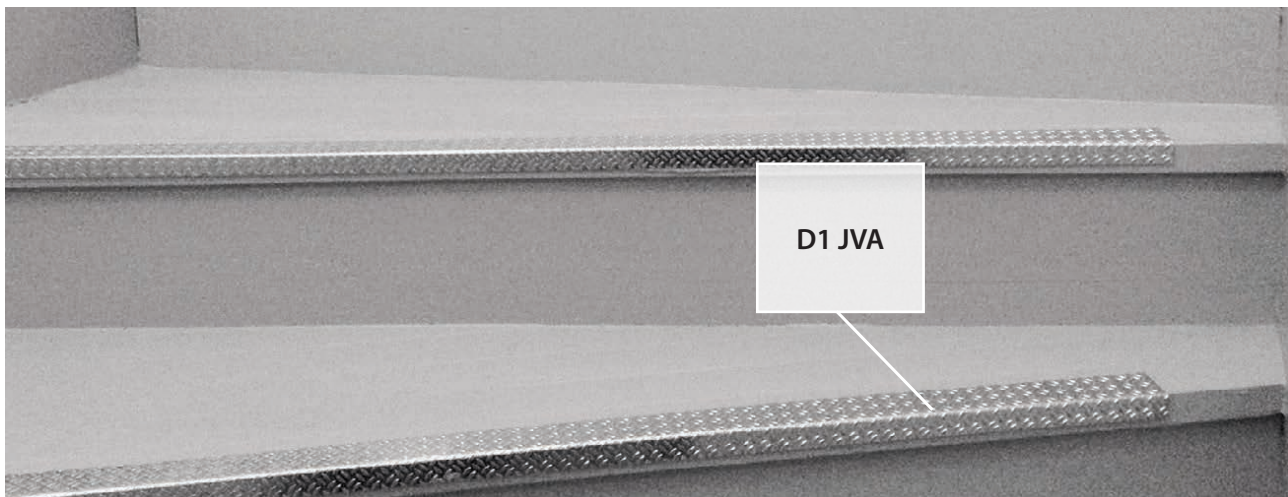

**Elasticfix-kiinnityksellä**  
 med Elasticfix-montering  
 with Elasticfix fastening

**ASKELKULMALISTAT**  
 TRAPPKANTLISTER  
 STAIR NOSINGS

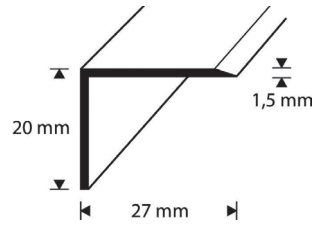

27 x 20 mm Sileä, RST | Slät, rostfritt stål | Smooth, stainless steel | ELASTICFIX

TUOTENRO PRODUKTNR PRODUCT NO	VÄRI	FÄRG	COLOUR		PITUUS LÄNGD LENGTH	EAN-KOODI EAN-KOD EAN-CODE
B7 RST 1	RST	Rostfritt stål	Stainless steel		1000	 6 4 17083 027932
B7 RST 2	RST	Rostfritt stål	Stainless steel		2000	 6 4 17083 027918
B7 RST 3	RST	Rostfritt stål	Stainless steel		3000	 6 4 17083 027925



**ASKELKULMALISTAT**  
**TRAPPKANTLISTER**  
**STAIR NOSINGS**

**ruuvi- tai liimakiinnityksellä**  
**med skruv eller lim-montering**  
**with screw or glue fastening**

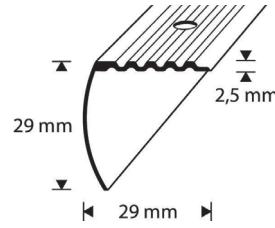

D4 HE



29 x 29 mm Uritettu, metalliväri | Spårad, metallfärg | Grooved, metal colour

TUOTENRO PRODUKTNR PRODUCT NO	VÄRI	FÄRG	COLOUR		PITUUS LÄNGD LENGTH	EAN-KOODI EAN-KOD EAN-CODE
D4 BL 90 ●	Musta-anodisoitu	Svart anodiserad	Black anodized		900	 6 417083 441592
D4 BL1	Musta-anodisoitu	Svart anodiserad	Black anodized		1000	 6 417083 031076
D4 BL2	Musta-anodisoitu	Svart anodiserad	Black anodized		2000	 6 417083 028380
D4 BL3	Musta-anodisoitu	Svart anodiserad	Black anodized		3000	 6 417083 031069
D4 HE1	Hopea-anodisoitu	Silver anodiserad	Silver anodized		1000	 6 417083 441202
D4 HE2	Hopea-anodisoitu	Silver anodiserad	Silver anodized		2000	 6 417083 929236
D4 HE3	Hopea-anodisoitu	Silver anodiserad	Silver anodized		3000	 6 417083 028397
D4 KE1	Kulta-anodisoitu	Guld anodiserad	Gold anodized		1000	 6 417083 441332
D4 KE2	Kulta-anodisoitu	Guld anodiserad	Gold anodized		2000	 6 417083 441325
D4 KE3	Kulta-anodisoitu	Guld anodiserad	Gold anodized		3000	 6 417083 628627
D4 PE1	Pronssi-anodisoitu	Brons anodiserad	Bronze anodized		1000	 6 417083 628634
D4 PE2	Pronssi-anodisoitu	Brons anodiserad	Bronze anodized		2000	 6 417083 031083
D4 PE3	Pronssi-anodisoitu	Brons anodiserad	Bronze anodized		3000	 6 417083 031090
7291401	Alumiini	Aluminium	Aluminium		2700	 6 417083 914010







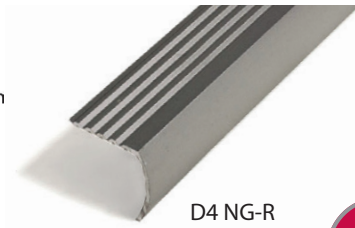
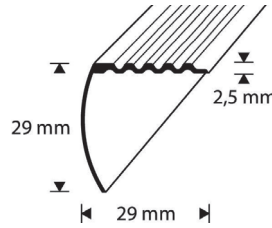







- **Poistuva tuote.** Kysy lisää myynnistä
- **Utgående produkt.** Fråga mer hos försäljningen
- **Discontinued product.** Contact sales for more information

**ruuvi- tai liimakiinnityksellä**  
**med skruv eller lim-montering**  
 with screw or glue fastening

**ASKELKULMALISTAT**  
**TRAPPKANTLISTER**  
 STAIR NOSINGS

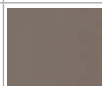

29 x 29 mm Uritettu, metalliväri | Spårad, metallfärg | Grooved, metal colour

TUOTENRO PRODUKTNR PRODUCT NO	VÄRI	FÄRG	COLOUR		PITUUS LÄNGD LENGTH	EAN-KOODI EAN-KOD EAN-CODE
D4 NG1-R	Nordic Graphite	Nordic Graphite	Nordic Graphite		1000	
D4 NG2-R	Nordic Graphite	Nordic Graphite	Nordic Graphite		2000	
D4 NG3-R	Nordic Graphite	Nordic Graphite	Nordic Graphite		3000	
7291401-R	Alumiini	Aluminium	Aluminium		2700	
7291402-R	Hopea-anodisoitu	Silver anodiserad	Silver anodized		3000	
7291403-R	Kulta-anodisoitu	Guld anodiserad	Gold anodized		2700	
7291406-R	Pronssi-anodisoitu	Brons anodiserad	Bronze anodized		3000	

**Nordic Graphite** -värisävy saattaa vaihdella valmistuksessa käytettävän harjaustekniikan vuoksi.  
 Nyansen **Nordic Graphite** kan variera beroende på den borstningsteknik som används vid tillverkningen.  
 The **Nordic Graphite** shade may vary according to the brushing technique used in manufacturing.

**ASKELKULMALISTAT**  
**TRAPPKANTLISTER**  
**STAIR NOSINGS**

**ruuvi- tai liimakiinnityksellä**  
**med skruv eller lim-montering**  
**with screw or glue fastening**

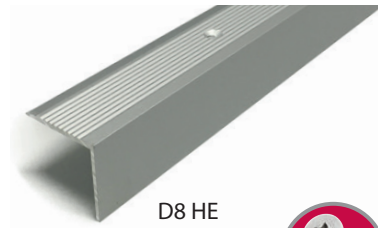
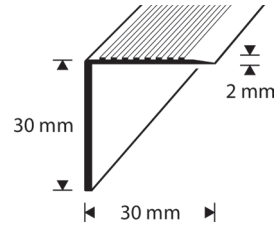

D8 HE



30 x 30 mm Uritettu, metalliväri | Spårad, metallfärg | Grooved, metal colour

TUOTENRO PRODUKTNR PRODUCT NO	VÄRI	FÄRG	COLOUR		PITUUS LÄNGD LENGTH	EAN-KOODI EAN-KOD EAN-CODE
D8 HE 90 ●	Hopea-anodisoitu	Silver anodiserad	Silver anodized		900	 6 417 083 0217 01
D8 HE1	Hopea-anodisoitu	Silver anodiserad	Silver anodized		1000	 6 417 083 0271 16
D8 HE 180 ●	Hopea-anodisoitu	Silver anodiserad	Silver anodized		1800	 6 417 083 0217 18
D8 HE2	Hopea-anodisoitu	Silver anodiserad	Silver anodized		2000	 6 417 083 0271 23
D8 HE3	Hopea-anodisoitu	Silver anodiserad	Silver anodized		3000	 6 417 083 0271 30
D8 KE 90 ●	Kulta-anodisoitu	Guld anodiserad	Gold anodized		900	 6 417 083 0216 71
D8 KE1	Kulta-anodisoitu	Guld anodiserad	Gold anodized		1000	 6 417 083 0271 78
D8 KE 180 ●	Kulta-anodisoitu	Guld anodiserad	Gold anodized		1800	 6 417 083 0216 88
D8 KE2	Kulta-anodisoitu	Guld anodiserad	Gold anodized		1000	 6 417 083 0271 85
D8 KE3	Kulta-anodisoitu	Guld anodiserad	Gold anodized		3000	 6 417 083 0271 92
D8 PE 90 ●	Pronssi-anodisoitu	Brons anodiserad	Bronze anodized		900	 6 417 083 0216 40
D8 PE1	Pronssi-anodisoitu	Brons anodiserad	Bronze anodized		1000	 6 417 083 0272 39
D8 PE2	Pronssi-anodisoitu	Brons anodiserad	Bronze anodized		2000	 6 417 083 0272 46
D8 PE3	Pronssi-anodisoitu	Brons anodiserad	Bronze anodized		3000	 6 417 083 0272 53

- **Poistuva tuote.** Kysy lisää myynnistä
- **Utgående produkt.** Fråga mer hos försäljningen
- **Discontinued product.** Contact sales for more information

**ruuvi- tai liimakiinnityksellä**  
**med skruv eller lim-montering**  
 with screw or glue fastening

**ASKELKULMALISTAT**  
**TRAPPKANTLISTER**  
 STAIR NOSINGS

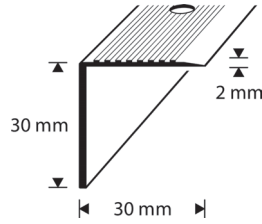

30 x 30 mm Uritettu, messinki | Spårad, mässing | Grooved, brass

TUOTENRO PRODUKTNR PRODUCT NO	VÄRI	FÄRG	COLOUR		PITUUS LÄNGD LENGTH	EAN-KOODI EAN-KOD EAN-CODE
7094704	Messinki	Mässing	Brass		3000	 6 4 17083 94704 9

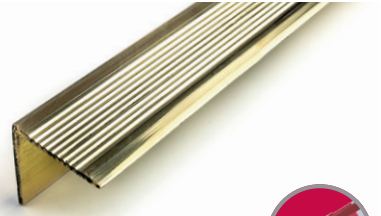
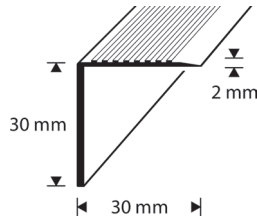

30 x 30 mm Uritettu, messinki | Spårad, mässing | Grooved, brass

TUOTENRO PRODUKTNR PRODUCT NO	VÄRI	FÄRG	COLOUR		PITUUS LÄNGD LENGTH	EAN-KOODI EAN-KOD EAN-CODE
7094704-R	Messinki	Mässing	Brass		3000	 6 4 17083 94794 0

# ASKELKULMALISTAT TRAPPKANTLISTER STAIR NOSINGS

ruuvi- tai liimakiinnityksellä  
med skruv eller lim-montering  
with screw or glue fastening

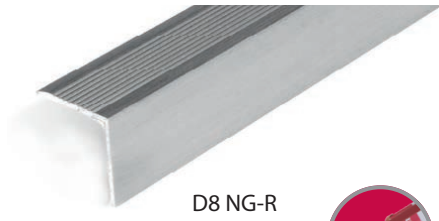
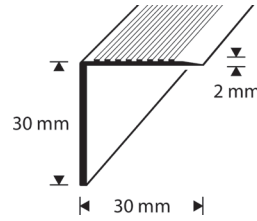

D8 NG-R



30 x 30 mm Uritettu, metalliväri | Spårad, metallfärg | Grooved, metal colour

TUOTENRO PRODUKTNR PRODUCT NO	VÄRI	FÄRG	COLOUR		PITUUS LÄNGD LENGTH	EAN-KOODI EAN-KOD EAN-CODE
D8 HE 90-R ●	Hopea-anodisoitu	Silver anodiserad	Silver anodized		900	 6 417 083 0217 32
D8 HE1-R	Hopea-anodisoitu	Silver anodiserad	Silver anodized		1000	 6 417 083 0271 47
D8 HE2-R	Hopea-anodisoitu	Silver anodiserad	Silver anodized		2000	 6 417 083 0271 54
D8 HE3-R	Hopea-anodisoitu	Silver anodiserad	Silver anodized		3000	 6 417 083 0271 61
D8 NG1-R	Nordic Graphite	Nordic Graphite	Nordic Graphite		1000	 6 417 083 0272 08
D8 NG2-R	Nordic Graphite	Nordic Graphite	Nordic Graphite		2000	 6 417 083 0272 15
D8 NG3-R	Nordic Graphite	Nordic Graphite	Nordic Graphite		3000	 6 417 083 0272 22
7094703-R	Kulta-anodisoitu	Guld anodiserad	Gold anodized		3000	 6 417 083 9470 32

- **Poistuva tuote.** Kysy lisää myynnistä
- **Utgående produkt.** Fråga mer hos försäljningen
- **Discontinued product.** Contact sales for more information



**Nordic Graphite** -värisävy saattaa vaihdella valmistuksessa käytettävän harjaustekniikan vuoksi.  
Nyansen **Nordic Graphite** kan variera beroende på den borstningsteknik som används vid tillverkningen.  
The **Nordic Graphite** shade may vary according to the brushing technique used in manufacturing.

**ruuvi- tai liimakiinnityksellä**  
**med skruv eller lim-montering**  
**with screw or glue fastening**

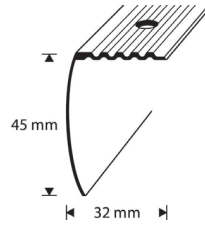
**ASKELKULMALISTAT**  
**TRAPPKANTLISTER**  
**STAIR NOSINGS**



32 x 45 mm Uritettu, alumiini | Spårad, aluminium | Grooved, aluminium



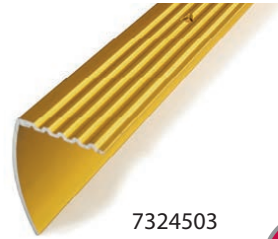
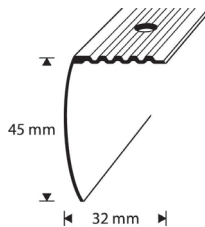

TUOTENRO PRODUKTNR PRODUCT NO	VÄRI	FÄRG	COLOUR		PITUUS LÄNGD LENGTH	EAN-KOODI EAN-KOD EAN-CODE
7324501	Alumiini, kiillotettu	Aluminium, polerad	Aluminium, polished		3000	 6 4 17083 24 5015



7324503



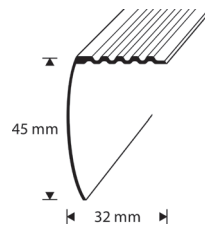

32 x 45 mm Uritettu, metalliväri | Spårad, metallfärg | Grooved, metal colour

TUOTENRO PRODUKTNR PRODUCT NO	VÄRI	FÄRG	COLOUR		PITUUS LÄNGD LENGTH	EAN-KOODI EAN-KOD EAN-CODE
7324503	Kulta-anodisoitu	Guld anodiserad	Gold anodized		3000	 6 4 17083 24 5039
7324506	Pronssi-anodisoitu	Brons anodiserad	Bronze anodized		3000	 6 4 17083 24 5060



32 x 45 mm Uritettu, alumiini | Spårad, aluminium | Grooved, aluminium

TUOTENRO PRODUKTNR PRODUCT NO	VÄRI	FÄRG	COLOUR		PITUUS LÄNGD LENGTH	EAN-KOODI EAN-KOD EAN-CODE
7324501-R	Alumiini, kiillotettu	Aluminium, polerad	Aluminium, polished		3000	 6 4 17083 24 5916

**ASKELKULMALISTAT**  
**TRAPPKANTLISTER**  
**STAIR NOSINGS**

**liimakiinnityksellä**  
**med lim-montering**  
**with glue fastening**

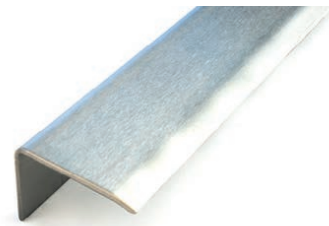
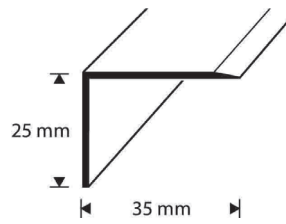

35 x 25 mm Sileä, RST | Slät, rostfritt stål | Smooth, stainless steel

TUOTENRO PRODUKTNR PRODUCT NO	VÄRI	FÄRG	COLOUR		PITUUS LÄNGD LENGTH	EAN-KOODI EAN-KOD EAN-CODE
7352505-R	RST	Rostfritt stål	Stainless steel		3000	 6 417083 525056

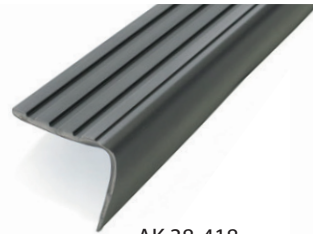
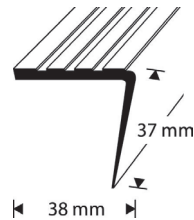



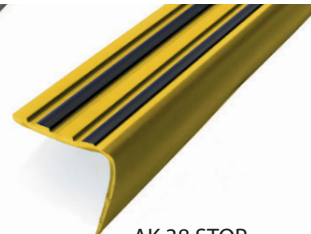









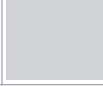



AK 38-418



AK 38 STOP



38 x 37 mm Uritettu, pehmeä muovi | Spårad, mjuk PVC | Grooved, soft PVC

TUOTENRO PRODUKTNR PRODUCT NO	VÄRI	FÄRG	COLOUR		PITUUS LÄNGD LENGTH	EAN-KOODI EAN-KOD EAN-CODE
AK 38-103	Tummanruskea	Mörk brun	Dark brown		2500	 6 417083 381034
AK 38-412	Vaalean harmaa	Ljus grå	Light grey		2500	 6 417083 384127
AK 38-414	Keskiharmaa	Grå	Grey		2500	 6 417083 384141
AK 38-418	Tummanharmaa	Mörk grå	Dark grey		2500	 6 417083 384189
AK 38-420	Beige	Beige	Beige		2500	 6 417083 384202
AK 38-422	Vaalea beige	Ljus beige	Light beige		2500	 6 417083 384226
AK 38-470	Musta	Svart	Black		2500	 6 417083 384707
AK 38 STOP	Keltamusta	Gul svart	Yellow black		2500	 6 417083 042492

**liimakiinnityksellä**  
med lim-montering  
with glue fastening

**ASKELKULMALISTAT**  
TRAPPKANTLISTER  
STAIR NOSINGS

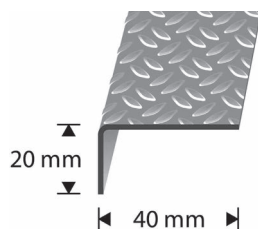

40 x 20 mm Jyväalu | Durkplåt mini | Grain surface

TUOTENRO PRODUKTNR PRODUCT NO	VÄRI	FÄRG	COLOUR		PITUUS LÄNGD LENGTH	EAN-KOODI EAN-KOD EAN-CODE
D10 JVA1	Alumiini	Aluminium	Aluminium		1000	 6 4 17083 017766
D10 JVA2	Alumiini	Aluminium	Aluminium		2000	 6 4 17083 017773

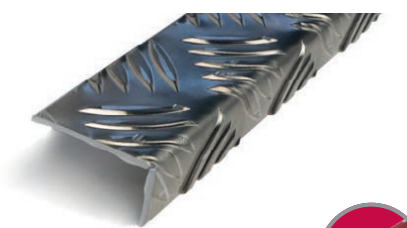
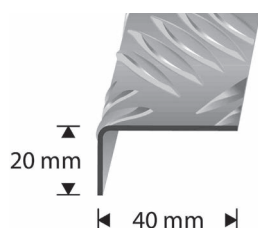

40 x 20 mm Turkkialu | Durkplåt maxi | Tear surface

TUOTENRO PRODUKTNR PRODUCT NO	VÄRI	FÄRG	COLOUR		PITUUS LÄNGD LENGTH	EAN-KOODI EAN-KOD EAN-CODE
D10 TLA1	Alumiini	Aluminium	Aluminium		1000	 6 4 17083 017780
D10 TLA2	Alumiini	Aluminium	Aluminium		2000	 6 4 17083 017827

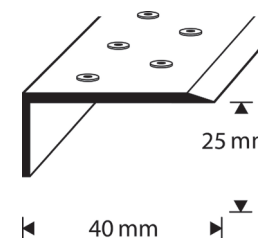

40 x 20 mm Kohopinta, RST | Reliefyta, rostfritt stål | Embossed surface, stainless steel

TUOTENRO PRODUKTNR PRODUCT NO	VÄRI	FÄRG	COLOUR		PITUUS LÄNGD LENGTH	EAN-KOODI EAN-KOD EAN-CODE
7352605-R	RST, hiottu	Rostfritt stål, borstat	Stainless steel, brushed		3000	 6 4 17083 526053

**ASKELKULMALISTAT**  
**TRAPPKANTLISTER**  
**STAIR NOSINGS**

**ruuvi- tai liimakiinnityksellä**  
**med skruv eller lim-montering**  
**with screw or glue fastening**

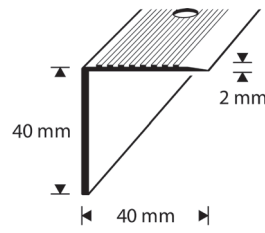

40 x 40 mm Uritettu, metalliväri | Spårad, metallfärg | Grooved, metal colour

TUOTENRO PRODUKTI PRODUCT NO	VÄRI	FÄRG	COLOUR		PITUUS LÄNGD LENGTH	EAN-KOODI EAN-KOD EAN-CODE
D9 HE 90 ●	Hopea-anodisoitu	Silver anodiserad	Silver anodized		900	6 4 1 7 0 8 3 0 2 1 8 2 4
D9 HE1	Hopea-anodisoitu	Silver anodiserad	Silver anodized		1000	6 4 1 7 0 8 3 0 2 7 2 6 0
D9 HE2	Hopea-anodisoitu	Silver anodiserad	Silver anodized		2000	6 4 1 7 0 8 3 0 2 7 2 7 7
D9 HE3	Hopea-anodisoitu	Silver anodiserad	Silver anodized		3000	6 4 1 7 0 8 3 0 2 7 2 8 4
D9 KE 90 ●	Kulta-anodisoitu	Guld anodiserad	Gold anodized		900	6 4 1 7 0 8 3 0 2 1 7 9 4
D9 KE1	Kulta-anodisoitu	Guld anodiserad	Gold anodized		1000	6 4 1 7 0 8 3 0 2 7 3 2 1
D9 KE 180 ●	Kulta-anodisoitu	Guld anodiserad	Gold anodized		1800	6 4 1 7 0 8 3 0 2 1 8 0 0
D9 KE2	Kulta-anodisoitu	Guld anodiserad	Gold anodized		2000	6 4 1 7 0 8 3 0 2 7 3 3 8
D9 KE3	Kulta-anodisoitu	Guld anodiserad	Gold anodized		3000	6 4 1 7 0 8 3 0 2 7 3 4 5
D9 PE 90 ●	Pronssi-anodisoitu	Brons anodiserad	Bronze anodized		900	6 4 1 7 0 8 3 0 2 1 7 6 3
D9 PE1	Pronssi-anodisoitu	Brons anodiserad	Bronze anodized		1000	6 4 1 7 0 8 3 0 2 7 3 8 3
D9 PE2	Pronssi-anodisoitu	Brons anodiserad	Bronze anodized		2000	6 4 1 7 0 8 3 0 2 7 3 9 0
D9 PE3	Pronssi-anodisoitu	Brons anodiserad	Bronze anodized		3000	6 4 1 7 0 8 3 0 2 7 4 0 6

- **Poistuva tuote.** Kysy lisää myynnistä
- **Utgående produkt.** Fråga mer hos försäljningen
- **Discontinued product.** Contact sales for more information

**liimakiinnityksellä**  
med lim-montering  
with glue fastening

**ASKELKULMALISTAT**  
TRAPPKANTLISTER  
STAIR NOSINGS

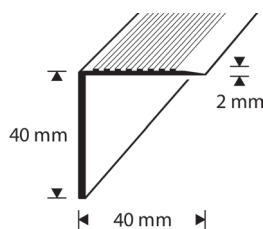

D9 HE-R



40 x 40 mm Uritettu, metalliväri | Spårad, metallfärg | Grooved, metal colour

TUOTENRO PRODUKTNR PRODUCT NO	VÄRI	FÄRG	COLOUR		PITUUS LÄNGD LENGTH	EAN-KOODI EAN-KOD EAN-CODE
D9 HE 90-R ●	Hopea-anodisoitu	Silver anodiserad	Silver anodized		900	 6 4 17083 021855
D9 HE1-R	Hopea-anodisoitu	Silver anodiserad	Silver anodized		1000	 6 4 17083 027291
D9 HE2-R	Hopea-anodisoitu	Silver anodiserad	Silver anodized		2000	 6 4 17083 027307
D9 HE3-R	Hopea-anodisoitu	Silver anodiserad	Silver anodized		3000	 6 4 17083 027314
D9 NG 90-R ●	Nordic Graphite	Nordic Graphite	Nordic Graphite		900	 6 4 17083 021886
D9 NG1-R	Nordic Graphite	Nordic Graphite	Nordic Graphite		1000	 6 4 17083 027352
D9 NG2-R	Nordic Graphite	Nordic Graphite	Nordic Graphite		2000	 6 4 17083 027369
D9 NG3-R	Nordic Graphite	Nordic Graphite	Nordic Graphite		3000	 6 4 17083 027376

- **Poistuva tuote.** Kysy lisää myynnistä
- **Utgående produkt.** Fråga mer hos försäljningen
- **Discontinued product.** Contact sales for more information



**Nordic Graphite** -värisävy saattaa vaihdella valmistuksessa käytettävän harjaustekniikan vuoksi.  
Nyansen **Nordic Graphite** kan variera beroende på den borstningsteknik som används vid tillverkningen.  
The **Nordic Graphite** shade may vary according to the brushing technique used in manufacturing.

**ASKELKULMALISTAT**  
**TRAPPKANTLISTER**  
**STAIR NOSINGS**



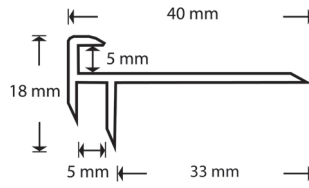









**ruuvi- tai liimakiinnityksellä**  
**med skruv eller lim-montering**  
**with screw or glue fastening**



DV5 HE



18 x 40 x 5 mm Askelkulma LVT, metallväri | Trappkantlist LVT, metallfärg  
 Stair nosing LVT, metal colour

TUOTENRO PRODUKTNR PRODUCT NO	VÄRI	FÄRG	COLOUR		PITUUS LÄNGD LENGTH	EAN-KOODI EAN-KOD EAN-CODE
DV5 HE1	Hopea-anodisoitu	Silver anodiserad	Silver anodized		1000	 6 4 1 7 0 8 3 0 3 5 9 7 5
DV5 HE2	Hopea-anodisoitu	Silver anodiserad	Silver anodized		2000	 6 4 1 7 0 8 3 0 3 5 9 8 2
DV5 HE3	Hopea-anodisoitu	Silver anodiserad	Silver anodized		3000	 6 4 1 7 0 8 3 0 3 5 9 9 9
DV5 NG1	Nordic Graphite	Nordic Graphite	Nordic Graphite		1000	 6 4 1 7 0 8 3 0 3 5 9 4 4
DV5 NG2	Nordic Graphite	Nordic Graphite	Nordic Graphite		2000	 6 4 1 7 0 8 3 0 3 5 9 5 1
DV5 NG3	Nordic Graphite	Nordic Graphite	Nordic Graphite		3000	 6 4 1 7 0 8 3 0 3 5 9 6 8

**Nordic Graphite** -värisävy saattaa vaihdella valmistuksessa käytettävän harjaustekniikan vuoksi.  
 Nyansen **Nordic Graphite** kan variera beroende på den borstningsteknik som används vid tillverkningen.  
 The **Nordic Graphite** shade may vary according to the brushing technique used in manufacturing.

**ruuvi- tai liimakiinnityksellä**  
**med skruv eller lim-montering**  
 with screw or glue fastening

**ASKELKULMALISTAT**  
**TRAPPKANTLISTER**  
 STAIR NOSINGS

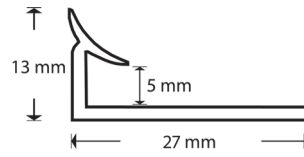

DIV5 NG



13,5 x 27 x 5 mm Portaan sisäkulmalista LVT, metalliväri | Innerhörn för trappa LVT, metallfärg  
 Inner corner for stairs LVT, metal colour

TUOTENRO PRODUKTI PRODUCT NO	VÄRI	FÄRG	COLOUR		PITUUS LÄNGD LENGTH	EAN-KOODI EAN-KOD EAN-CODE
DIV5 HE1	Hopea-anodisoitu	Silver anodiserad	Silver anodized		1000	6 4 1 7 0 8 3 0 3 6 0 3 3
DIV5 HE2	Hopea-anodisoitu	Silver anodiserad	Silver anodized		2000	6 4 1 7 0 8 3 0 3 6 0 4 0
DIV5 HE3	Hopea-anodisoitu	Silver anodiserad	Silver anodized		3000	6 4 1 7 0 8 3 0 3 6 0 5 7
DIV5 NG1	Nordic Graphite	Nordic Graphite	Nordic Graphite		1000	6 4 1 7 0 8 3 0 3 6 0 0 2
DIV5 NG2	Nordic Graphite	Nordic Graphite	Nordic Graphite		2000	6 4 1 7 0 8 3 0 3 6 0 1 9
DIV5 NG3	Nordic Graphite	Nordic Graphite	Nordic Graphite		3000	6 4 1 7 0 8 3 0 3 6 0 2 6

**Nordic Graphite** -värisävy saattaa vaihdella valmistuksessa käytettävän harjaustekniikan vuoksi.  
 Nyansen **Nordic Graphite** kan variera beroende på den borstningsteknik som används vid tillverkningen.  
 The **Nordic Graphite** shade may vary according to the brushing technique used in manufacturing.

**ASKELKULMALISTAT**  
**TRAPPKANTLISTER**  
**STAIR NOSINGS**

**ruuvi- tai liimakiinnityksellä**  
**med skruv eller lim-montering**  
**with screw or glue fastening**

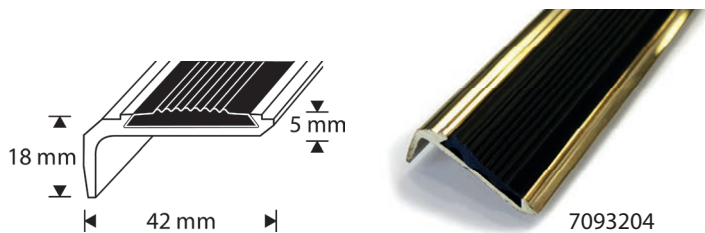

42 x 18 mm Metalli + rihlattu PVC-liukeste  
 Metall, med räfflad PVC-halkskyddsinnlägg  
 Metal, with ridged PVC anti-slip insert

TUOTENRO PRODUKTNR PRODUCT NO	VÄRI	FÄRG	COLOUR		PITUUS LÄNGD LENGTH	EAN-KOODI EAN-KOD EAN-CODE
7093201	Alumiini	Aluminium	Aluminium		2700	 6 4 17083 932113
7093203	Kulta-anodisoitu	Guld anodiserad	Gold anodized		2700	 6 4 17083 932038
7093203-GLOW	Kulta-anodisoitu, keltainen hohto	Guld anodiserad, lysande gul	Gold anodized, yellow glow		2700	 6 4 17083 040627
7093204	Messinki	Mässing	Brass		2700	 6 4 17083 932045

Katso myös **liukesteet** sivu 120 | Se också **halkskyddsinnläggen** på sidan 120 | See also **anti-slip inserts** on page 120

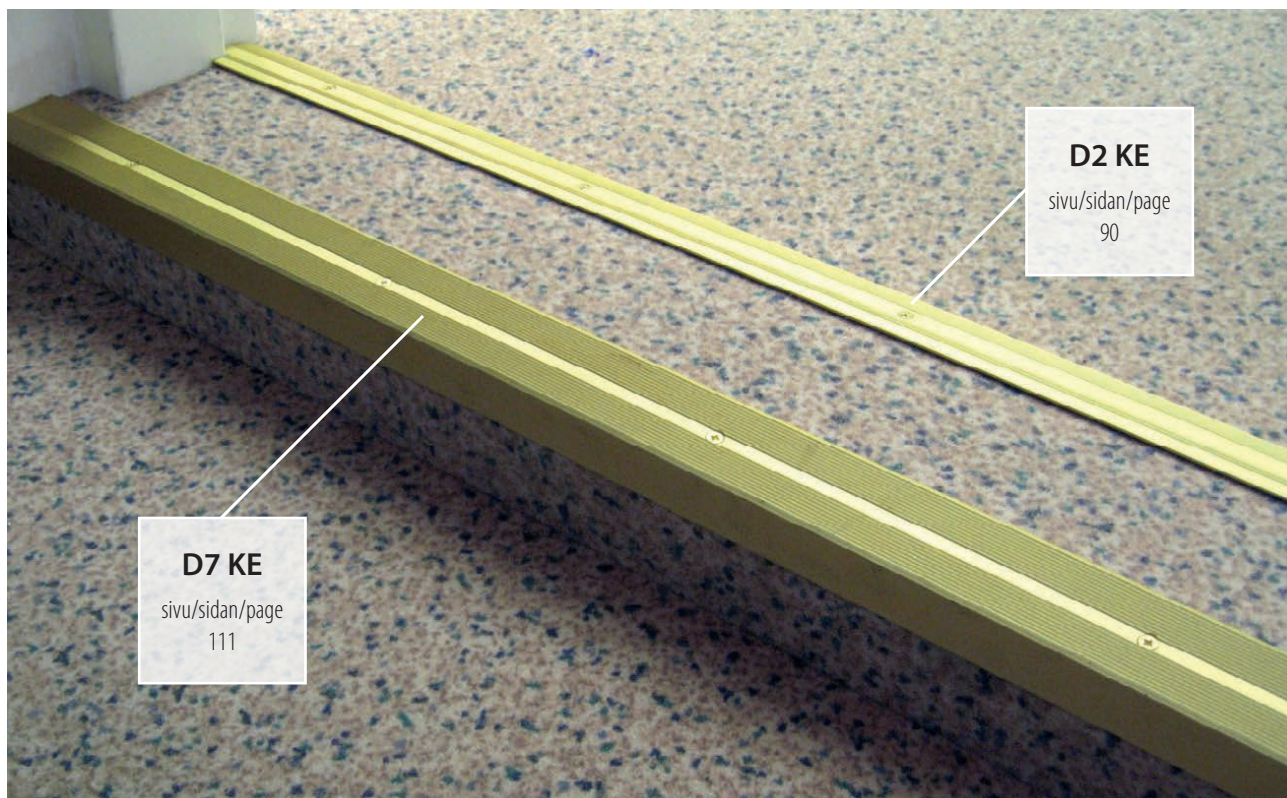

**ruuvi- tai liimakiinnityksellä**  
**med skruv eller lim-montering**  
**with screw or glue fastening**

**ASKELKULMALISTAT**  
**TRAPPKANTLISTER**  
**STAIR NOSINGS**

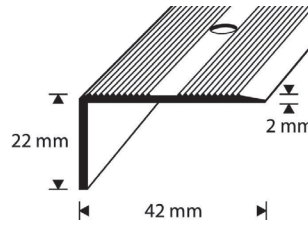

42 x 22 mm Uritettu, metalliväri | Spårad, metallfärg | Grooved, metal colour

TUOTENRO PRODUKTNR PRODUCT NO	VÄRI	FÄRG	COLOUR		PITUUS LÄNGD LENGTH	EAN-KOODI EAN-KOD EAN-CODE
D7 KE1	Kulta-anodisoitu	Guld anodiserad	Gold anodized		1000	
D7 KE2	Kulta-anodisoitu	Guld anodiserad	Gold anodized		2000	
D7 KE3	Kulta-anodisoitu	Guld anodiserad	Gold anodized		3000	
D7 KR 90 ●	Kromi-anodisoitu	Krom anodiserad	Chrome anodized		900	
D7 KR1	Kromi-anodisoitu	Krom anodiserad	Chrome anodized		1000	
D7 KR2	Kromi-anodisoitu	Krom anodiserad	Chrome anodized		2000	
D7 KR3	Kromi-anodisoitu	Krom anodiserad	Chrome anodized		3000	
D7 PE1	Pronssi-anodisoitu	Brons anodiserad	Bronze anodized		1000	
D7 PE2	Pronssi-anodisoitu	Brons anodiserad	Bronze anodized		2000	
D7 PE3	Pronssi-anodisoitu	Brons anodiserad	Bronze anodized		3000	

- **Poistuva tuote.** Kysy lisää myynnistä
- **Utgående produkt.** Fråga mer hos försäljningen
- **Discontinued product.** Contact sales for more information

**ASKELKULMALISTAT**  
**TRAPPKANTLISTER**  
**STAIR NOSINGS**

**ruuvi- tai liimakiinnityksellä**  
**med skruv eller lim-montering**  
**with screw or glue fastening**

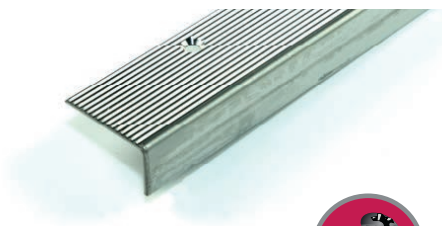
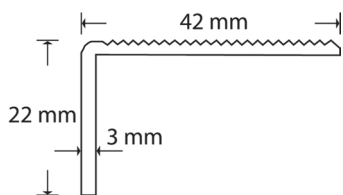

42 x 22 mm Uritettu, RST | Spårad, rostfritt stål | Grooved, stainless steel



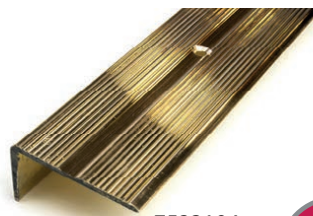
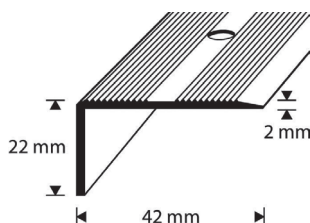

TUOTENRO PRODUKTNR PRODUCT NO	VÄRI	FÄRG	COLOUR		PITUUS LÄNGD LENGTH	EAN-KOODI EAN-KOD EAN-CODE
D7 RST3	RST	Rostfritt stål	Stainless steel		3000	 6 417083 038662



7523104



42 x 22 mm Uritettu, metalli | Spårad, metall | Grooved, metal

TUOTENRO PRODUKTNR PRODUCT NO	VÄRI	FÄRG	COLOUR		PITUUS LÄNGD LENGTH	EAN-KOODI EAN-KOD EAN-CODE
7523101	Alumiini	Aluminium	Aluminium		3000	 6 417083 231018
7523104	Messinki	Mässing	Brass		3000	 6 417083 231049

**liimakiinnityksellä**  
med lim-montering  
with glue fastening

**ASKELKULMALISTAT**  
TRAPPKANTLISTER  
STAIR NOSINGS

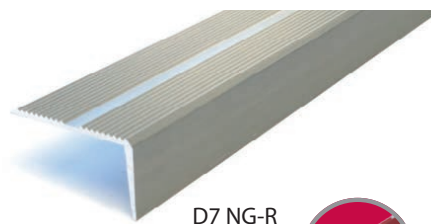
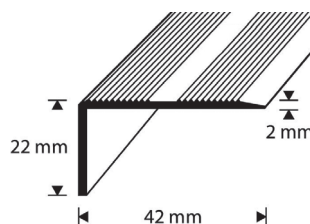

42 x 22 mm Uritettu, metalliväri | Spårad, metallfärg | Grooved, metal colour

TUOTENRO PRODUKTNR PRODUCT NO	VÄRI	FÄRG	COLOUR		PITUUS LÄNGD LENGTH	EAN-KOODI EAN-KOD EAN-CODE
7523101-R	Alumiini	Aluminium	Aluminium		3000	6 4 17083 231919
7523104-R	Messinki	Mässing	Brass		3000	6 4 17083 231940
7523106-R	Pronssi-anodisoitu	Brons anodiserad	Bronze anodized		3000	6 4 17083 231964
7523109-R	Kromi-anodisoitu	Krom anodiserad	Chrome anodized		3000	6 4 17083 231995
D7 NG1-R	Nordic Graphite	Nordic Graphite	Nordic Graphite		1000	6 4 17083 027086
D7 NG2-R	Nordic Graphite	Nordic Graphite	Nordic Graphite		2000	6 4 17083 027093
D7 NG3-R	Nordic Graphite	Nordic Graphite	Nordic Graphite		3000	6 4 17083 027109

**Nordic Graphite** -värisävy saattaa vaihdella valmistuksessa käytettävän harjaustekniikan vuoksi.  
Nyansen **Nordic Graphite** kan variera beroende på den borstningsteknik som används vid tillverkningen.  
The **Nordic Graphite** shade may vary according to the brushing technique used in manufacturing.

Askelkulmalistat  
Trappkantlister  
Stair nosings

**ASKELKULMALISTAT**  
**TRAPPKANTLISTER**  
 STAIR NOSINGS

**ruuvi- tai liimakiinnityksellä**  
 med skruv eller lim-montering  
 with screw or glue fastening

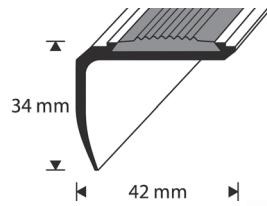

42 x 34 mm Alumiini + rihlattu PVC-liukueste | Aluminium, med räfflad PVC-halkskyddsinnlägg | Aluminium, with ridged PVC anti-slip insert

TUOTENRO PRODUKTNR PRODUCT NO	VÄRI	FÄRG	COLOUR		PITUUS LÄNGD LENGTH	EAN-KOODI EAN-KOD EAN-CODE
7092701	Alumiini	Aluminium	Aluminium		2700	 6417083927010

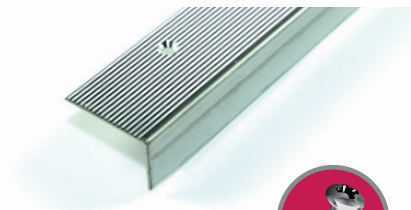
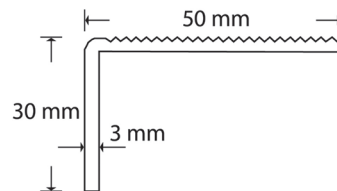

50 x 30 mm Uritettu, RST | Spårad, rostfritt stål | Grooved, stainless steel

TUOTENRO PRODUKTNR PRODUCT NO	VÄRI	FÄRG	COLOUR		PITUUS LÄNGD LENGTH	EAN-KOODI EAN-KOD EAN-CODE
70950305	RST	Rostfritt stål	Stainless steel		3000	 6417083038310

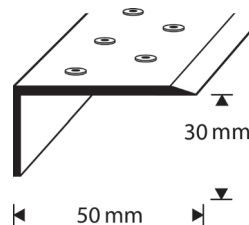

50 x 30 mm Kohopinta, RST | Reliefyta, rostfritt stål | Embossed surface, stainless steel



TUOTENRO PRODUKTNR PRODUCT NO	VÄRI	FÄRG	COLOUR		PITUUS LÄNGD LENGTH	EAN-KOODI EAN-KOD EAN-CODE
7352705-R	RST	Rostfritt stål	Stainless steel		3000	 6417083527050

**ruuvi- tai liimakiinnityksellä**  
**med skruv eller lim-montering**  
 with screw or glue fastening

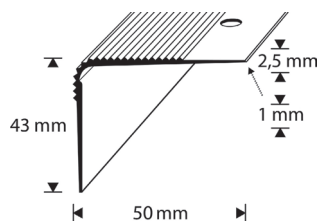
**ASKELKULMALISTAT**  
**TRAPPKANTLISTER**  
 STAIR NOSINGS



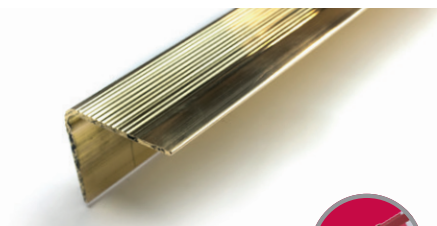
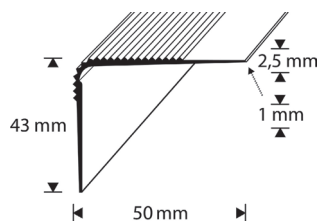

50 x 43 mm Uritettu, metalli | Spårad, metall | Grooved, metal

TUOTENRO PRODUKTNR PRODUCT NO	VÄRI	FÄRG	COLOUR		PITUUS LÄNGD LENGTH	EAN-KOODI EAN-KOD EAN-CODE
7095554	Messinki	Mässing	Brass		5000	 6 4 17083 95554 9



50 x 43 mm Uritettu, metalli | Spårad, metall | Grooved, metal

TUOTENRO PRODUKTNR PRODUCT NO	VÄRI	FÄRG	COLOUR		PITUUS LÄNGD LENGTH	EAN-KOODI EAN-KOD EAN-CODE
7095554-R	Messinki	Mässing	Brass		5000	 6 4 17083 95550 1

**ASKELKULMALISTAT**  
**TRAPPKANTLISTER**  
**STAIR NOSINGS**



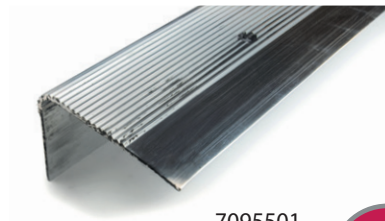
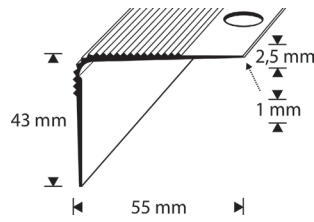

**ruuvi- tai liimakiinnityksellä**  
**med skruv eller lim-montering**  
**with screw or glue fastening**



7095501



55 x 43 mm Uritettu, metalli | Spårad, metall | Grooved, metal



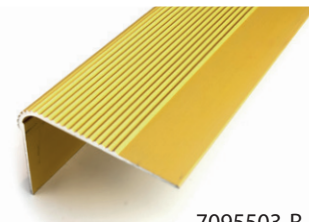
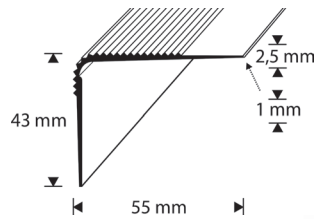

TUOTENRO PRODUKTNR PRODUCT NO	VÄRI	FÄRG	COLOUR		PITUUS LÄNGD LENGTH	EAN-KOODI EAN-KOD EAN-CODE
7095501	Alumiini	Aluminium	Aluminium		2700	 6 417083 955013
7095503	Kulta-anodisoitu	Guld anodiserad	Gold anodized		2700	 6 417083 955037



7095503-R



55 x 43 mm Uritettu, metalli | Spårad, metall | Grooved, metal



TUOTENRO PRODUKTNR PRODUCT NO	VÄRI	FÄRG	COLOUR		PITUUS LÄNGD LENGTH	EAN-KOODI EAN-KOD EAN-CODE
7095501-R	Alumiini	Aluminium	Aluminium		2700	 6 417083 905018
7095503-R	Kulta-anodisoitu	Guld anodiserad	Gold anodized		2700	 6 417083 955303

**ruuvi- tai liimakiinnityksellä**  
**med skruv eller lim-montering**  
**with screw or glue fastening**

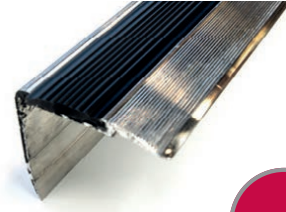
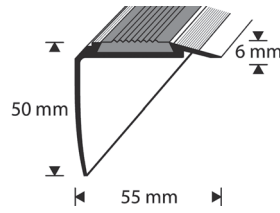
**ASKELKULMALISTAT**  
**TRAPPKANTLISTER**  
**STAIR NOSINGS**



55 x 50 mm Alumiini + rihlattu PVC-liukeste | Aluminium, med räfflad  
 PVC-halkskyddsinnlägg | Aluminium, with ridged PVC anti-slip insert

TUOTENRO PRODUKTNR PRODUCT NO	VÄRI	FÄRG	COLOUR		PITUUS LÄNGD LENGTH	EAN-KOODI EAN-KOD EAN-CODE
7555001	Alumiini	Aluminium	Aluminium		3200	 6 4 17083 550010
7555001 GLOW	Kulta-anodisoitu, keltainen hohto	Guld anodiserad, lysande gul	Gold anodized, yellow glow		3200	 6 4 17083 041716

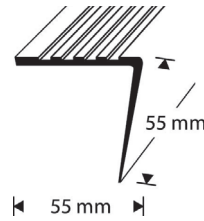

Katso myös **liukesteet** sivu 120 | Se också **halkskyddsinnläggen** på sidan 120 | See also **anti-slip inserts** on page 120



AK 55-412



55 x 55 mm Uritettu, pehmeä muovi | Spårad, mjuk PVC | Grooved, soft PVC

TUOTENRO PRODUKTNR PRODUCT NO	VÄRI	FÄRG	COLOUR		PITUUS LÄNGD LENGTH	EAN-KOODI EAN-KOD EAN-CODE
AK 55-412	Vaalean harmaa	Ljus grå	Light grey		2500	 6 4 17083 554124
AK 55-470	Musta	Svart	Black		2500	 6 4 17083 554704

**ASKELKULMALISTAT**  
**TRAPPKANTLISTER**  
**STAIR NOSINGS**

**ruuvi- tai liimakiinnityksellä**  
**med skruv eller lim-montering**  
**with screw or glue fastening**

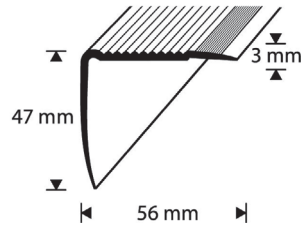

56 x 47 mm Uritettu, metalliväri | Spårad, metallfärg | Grooved, metal colour

TUOTENRO PRODUKTNR PRODUCT NO	VÄRI	FÄRG	COLOUR		PITUUS LÄNGD LENGTH	EAN-KOODI EAN-KOD EAN-CODE
7564702	Hopea-anodisoitu	Silver anodiserad	Silver anodized		3200	 6 417083 647024
7564703	Kulta-anodisoitu	Guld anodiserad	Gold anodized		3200	 6 417083 647031

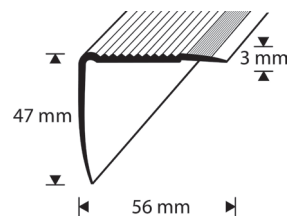

56 x 47 mm Uritettu, metalliväri | Spårad, metallfärg | Grooved, metal colour

TUOTENRO PRODUKTNR PRODUCT NO	VÄRI	FÄRG	COLOUR		PITUUS LÄNGD LENGTH	EAN-KOODI EAN-KOD EAN-CODE
7564702-R	Hopea-anodisoitu	Silver anodiserad	Silver anodized		3200	 6 417083 647123
7564703-R	Kulta-anodisoitu	Guld anodiserad	Gold anodized		3200	 6 417083 647130

**ruuvi- tai liimakiinnityksellä**  
**med skruv eller lim-montering**  
 with screw or glue fastening

**ASKELKULMALISTAT**  
**TRAPPKANTLISTER**  
 STAIR NOSINGS

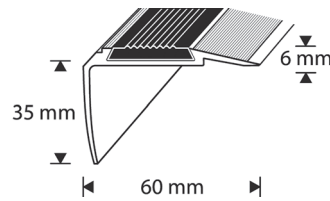

60 x 35 mm Alumiini + rihlattu PVC-liukeste | Aluminium, med räfflad  
 PVC-halkskyddsinnlägg | Aluminium, with ridged PVC anti-slip insert

TUOTENRO PRODUKTNR PRODUCT NO	VÄRI	FÄRG	COLOUR		PITUUS LÄNGD LENGTH	EAN-KOODI EAN-KOD EAN-CODE
7603501	Alumiini	Aluminium	Aluminium		3200	6 4 17083 028472

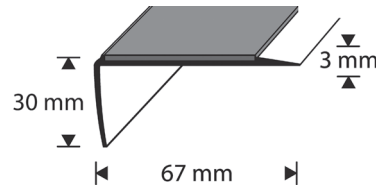

67 x 30 mm Alumiini + PVC-liukeste  
 Aluminium med PVC-halkskyddsinnlägg | Aluminium with PVC anti-slip insert

TUOTENRO PRODUKTNR PRODUCT NO	VÄRI	FÄRG	COLOUR		PITUUS LÄNGD LENGTH	EAN-KOODI EAN-KOD EAN-CODE
7093301	Alumiini	Aluminium	Aluminium		3200	6 4 17083 933011

Katso myös **liukesteet** sivu 120 | Se också **halkskyddsinnläggen** på sidan 120 | See also **anti-slip inserts** on page 120

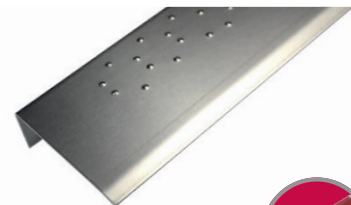
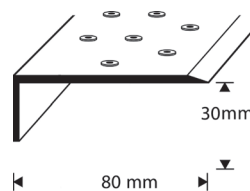

80 x 30 mm Kohopinta, RST | Reliefyta, rostfritt stål | Embossed surface, stainless steel



TUOTENRO PRODUKTNR PRODUCT NO	VÄRI	FÄRG	COLOUR		PITUUS LÄNGD LENGTH	EAN-KOODI EAN-KOD EAN-CODE
7352805-R	RST	Rostfritt stål	Stainless steel		3000	6 4 17083 528057

**ASKELKULMALISTAT**  
**TRAPPKANTLISTER**  
 STAIR NOSINGS

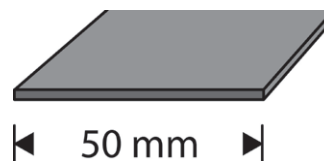
**liukuesteet**  
 hallskydd  
 anti-slip





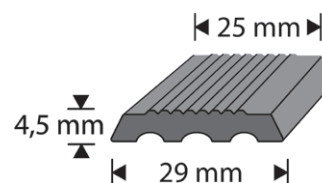

50 mm Liukueste, sileä | Halkskyddsinnlägg, slät | Anti-slip insert, smooth  
 Askelkulmalle 7093301 | För trappkant 7093301 | For stair nosing 7093301

TUOTENRO PRODUKTNR PRODUCT NO	VÄRI	FÄRG	COLOUR		PITUUS LÄNGD LENGTH	EAN-KOODI EAN-KOD EAN-CODE
7093301-1	Musta	Svart	Black		25 m	 6 417083 933073





28 mm Liukueste, rihlattu | Halkskyddsinnlägg, räfflad | Anti-slip insert, ridged  
 Askelkulmalle 7093203/7093204 | För trappkant 7093203/7093204 | For stair nosing 7093203/7093204

TUOTENRO PRODUKTNR PRODUCT NO	VÄRI	FÄRG	COLOUR		PITUUS LÄNGD LENGTH	EAN-KOODI EAN-KOD EAN-CODE
7093204-001	Musta	Svart	Black		25 m	 6 417083 932144
7093204-005	Keltainen, hohto	Gul, lysande	Yellow, glow		25 m	 6 417083 041693





30 x 3 mm Liukuestelista, rihlattu | Halkskyddslist, räfflad | Anti-slip strip, ridged

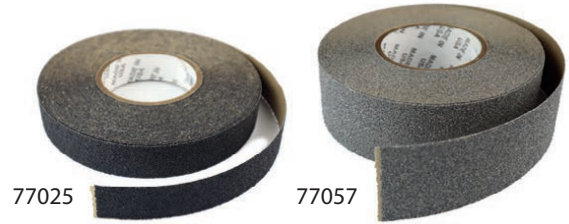





TUOTENRO PRODUKTNR PRODUCT NO	VÄRI	FÄRG	COLOUR		PITUUS LÄNGD LENGTH	EAN-KOODI EAN-KOD EAN-CODE
7096004	Messinki	Mässing	Brass		2500	 6 417083 960048











21 mm Liukuesteteippi | Hallskydds tejp | Anti-slip tape

TUOTENRO PRODUKTNR PRODUCT NO	VÄRI	FÄRG	COLOUR		PITUUS LÄNGD LENGTH	EAN-KOODI EAN-KOD EAN-CODE
77023	Musta	Svart	Black		18,3 m	 6 4 17083 770234



25 mm Liukuesteteippi | Hallskydds tejp | Anti-slip tape

TUOTENRO PRODUKTNR PRODUCT NO	VÄRI	FÄRG	COLOUR		PITUUS LÄNGD LENGTH	EAN-KOODI EAN-KOD EAN-CODE
77025	Musta	Svart	Black		18,3 m	 6 4 17083 770258
77027	Harmaa	Grå	Grey		18,3 m	 6 4 17083 770258
77030	Väritön	Transparent	Transparent		18,3 m	 6 4 17083 770302

50 mm Liukuesteteippi | Hallskydds tejp | Anti-slip tape

TUOTENRO PRODUKTNR PRODUCT NO	VÄRI	FÄRG	COLOUR		PITUUS LÄNGD LENGTH	EAN-KOODI EAN-KOD EAN-CODE
77050	Musta	Svart	Black		18,3 m	 6 4 17083 770500
77057	Harmaa	Grå	Grey		18,3 m	 6 4 17083 770579
77056	Valkoinen	Vit	White		18,3 m	 6 4 17083 770562
77060	Väritön	Transparent	Transparent		18,3 m	 6 4 17083 770609

102 mm Liukuesteteippi | Hallskydds tejp | Anti-slip tape

TUOTENRO PRODUKTNR PRODUCT NO	VÄRI	FÄRG	COLOUR		PITUUS LÄNGD LENGTH	EAN-KOODI EAN-KOD EAN-CODE
77051	Musta	Svart	Black		18,3 m	 6 4 17083 770517

**ASKELKULMALISTAT**  
**TRAPPKANTLISTER**  
**STAIR NOSINGS**



**porraskonsolit**  
**trappkonsoler**  
**stair consoles**





Ø 9 mm Porrasputki | Trapprör | Stair tube

TUOTENRO PRODUKTNR PRODUCT NO	VÄRI	FÄRG	COLOUR		PITUUS LÄNGD LENGTH	EAN-KOODI EAN-KOD EAN-CODE
70474	Käsitlemätön messinki	Mässing	Brass		5 m	 6 417083 70474 1

Porrasputken päätykappale | Ändplugg | End plug

70475	Messinki	Mässing	Brass		–	 6 417083 70475 8
-------	----------	---------	-------	--	---	---

Porraskonsoli | Konsol | Console

70476	Messinki	Mässing	Brass		30 mm	 6 417083 70476 5
-------	----------	---------	-------	--	-------	---

# PÄÄTELISTAT AVSLUTNINGSLISTER FINISHING PROFILES

## LIITÄ LATTIA KYNNYKSEEN.

Päätelistoja käytetään siellä, missä uiva lattia yhdistyy kynnykseen. Listan käyttäminen mahdollistaa parketti- tai laminaattipäällysteen jatkamisen kynnykselle asti. Päätelistat soveltuvat myös uivan lattian tasanteiden reunoihin. Dione-valikoimaan kuuluvat myös erilliset kokolattiamatoille soveltuvat päätelistat.

## FOGA IHOP GOLVET MED TRÖSKELN.

Avslutningslister används där flytande golv möter en tröskel. Med hjälp av listen kan parkett- eller laminatgolvet nå ända in till tröskeln. Avslutningslisterna passar även för flytande golv i dörröppningar.

I Dione-sortimentet finns det även separata avslutningslister för mattor.

## LINK FLOOR TO THRESHOLD.

Finishing profiles are used where a floating floor meets a threshold. The use of the profile allows the parquet or laminate flooring to be installed against a threshold. The finishing profiles are also suitable for the edges of the floating floor.

The Dione assortment includes finishing profiles also for carpeting.

**PÄÄTELISTAT**  
**AVSLUTNINGSLISTER**  
 FINISHING PROFILES

**teippi- tai alakiskokiinnityksellä**  
 med tejpmontering eller underskena  
 with tape fastening or underrail

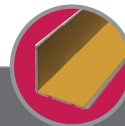
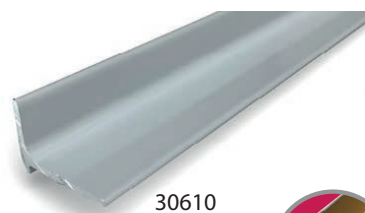
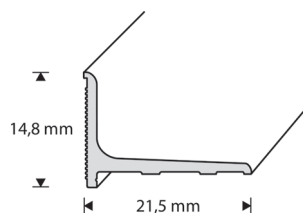

21,5 x 14,8 mm Tarrapäätelista kynnyksen ja parketin liikuntasamaan  
 Avslutningsprofiler för trösklar och parkett  
 Finishing profiles for thresholds and parquet

TUOTENRO PRODUKTNR PRODUCT NO	VÄRI	FÄRG	COLOUR		PITUUS LÄNGD LENGTH	EAN-KOODI EAN-KOD EAN-CODE
30615	Maalattu valkoinen	Vitmålad	Painted white		2700	6 417083 021213
30610	Hopea-anodisoitu	Silver anodiserad	Silver anodized		2700	6 417083 021220

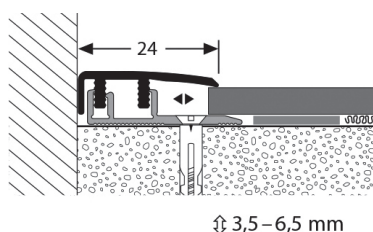

24 x 3,5–6,5 mm Päätelista alakiskokiinnityksellä vinylille | Puukuvioitu  
 Avslutningsprofil med underskena för vinyl | Träimitation  
 Finishing profile with underrail for vinyl | Wood imitation

TUOTENRO PRODUKTNR PRODUCT NO	VÄRI	FÄRG	COLOUR		PITUUS LÄNGD LENGTH	EAN-KOODI EAN-KOD EAN-CODE
E24L CW 1	Cotton white	Cotton white	Cotton white		1000	6 417083 043246
E24L CW2	Cotton white	Cotton white	Cotton white		2000	6 417083 043253
E24L CW 3	Cotton white	Cotton white	Cotton white		3000	6 417083 041075
E24L LA 1	Valkaistu saarni	Vitkalkad ask	Limed ash		1000	6 417083 043321
E24L LA2	Valkaistu saarni	Vitkalkad ask	Limed ash		2000	6 417083 043338
E24L LA 3	Valkaistu saarni	Vitkalkad ask	Limed ash		3000	6 417083 041082

JATKUU SEURAAVALLA SIVULLA  
 FORTSÄTTER PÅ NÄSTA SIDA  
 CONTINUED ON THE NEXT PAGE



**alakiskokiinnityksellä**  
med underskena  
with underrail

**PÄÄTELISTAT**  
AVSLUTNINGSLISTER  
FINISHING PROFILES

← JATKOVA EDELLISELTÄ SIVULTA  
FORTSÄTTER FRÅN FÖREGÅENDE SIDA  
CONTINUED FROM THE PREVIOUS PAGE

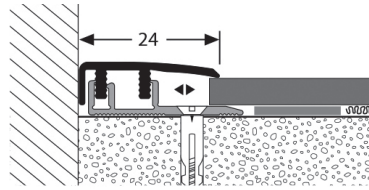

























↑ 3,5–6,5 mm



E24L NOA



24 x 3,5–6,5 mm Päätelista alakiskokiinnityksellä vinylille | Puukuvioitu  
Avslutningsprofil med underskena för vinyl | Träimitation  
Finishing profile with underrail for vinyl | Wood imitation

TUOTENRO PRODUKTNR PRODUCT NO	VÄRI	FÄRG	COLOUR		PITUUS LÄNGD LENGTH	EAN-KOODI EAN-KOD EAN-CODE
E24L LO 1	Harmaa tammi	Ljus ek	Light oak		1000	 6 4 17083 043345
E24L LO2	Harmaa tammi	Ljus ek	Light oak		2000	 6 4 17083 043352
E24L LO 3	Harmaa tammi	Ljus ek	Light oak		3000	 6 4 17083 041099
E24L NOA 1	Natural Oak	Natural Oak	Natural Oak		1000	 6 4 17083 043390
E24L NOA 2	Natural Oak	Natural Oak	Natural Oak		2000	 6 4 17083 043406
E24L NOA 3	Natural Oak	Natural Oak	Natural Oak		3000	 6 4 17083 041105
E24L OAK 1	Cream Oak	Cream Oak	Cream Oak		1000	 6 4 17083 024634
E24L OAK 2	Cream Oak	Cream Oak	Cream Oak		2000	 6 4 17083 024627
E24L OAK 3	Cream Oak	Cream Oak	Cream Oak		3000	 6 4 17083 024610
E24L TA 1	Tammi	Ek	Oak		1000	 6 4 17083 043444
E24L TA2	Tammi	Ek	Oak		2000	 6 4 17083 043451
E24L TA 3	Tammi	Ek	Oak		3000	 6 4 17083 041112

**PÄÄTELISTAT**  
**AVSLUTNINGSLISTER**  
**FINISHING PROFILES**



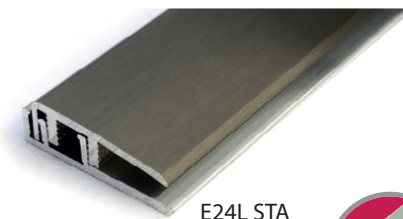
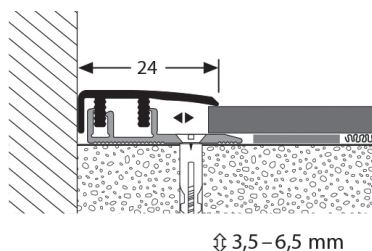







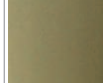

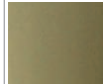

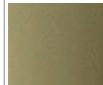



**alakiskokiinnityksellä**  
**med underskena**  
**with underrail**



E24L STA

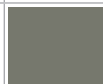

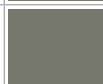
24 mm H=3,5–6,5 mm Päätelista alakiskokiinnityksellä vinyylille  
 Avslutningsprofil med underskena för vinyl  
 Finishing profile with underrail for vinyl







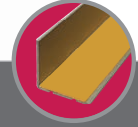
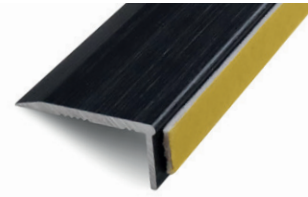
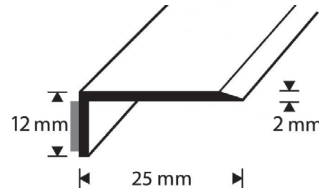











TUOTENRO PRODUKTNR PRODUCT NO	VÄRI	FÄRG	COLOUR		PITUUS LÄNGD LENGTH	EAN-KOODI EAN-KOD EAN-CODE
E24L SAND 1	Sand	Sand anodiserad	Sand		1000	 6 4 170 83 0 245 4 2
E24L SAND 2	Sand	Sand anodiserad	Sand		2000	 6 4 170 83 0 245 3 3
E24L SAND 3	Sand	Sand anodiserad	Sand		3000	 6 4 170 83 0 245 2 8
E24L SI 1	Hopea-anodisoitu	Silver anodiserad	Silver anodized		1000	 6 4 170 83 0 245 7 3
E24L SI 2	Hopea-anodisoitu	Silver anodiserad	Silver anodized		2000	 6 4 170 83 0 245 6 6
E24L SI 3	Hopea-anodisoitu	Silver anodiserad	Silver anodized		3000	 6 4 170 83 0 245 5 9
E24L STA 1	RST-anodisoitu	Rostfritt stål anodiserad	Stainless steel anodized		1000	 6 4 170 83 0 246 0 3
E24L STA 2	RST-anodisoitu	Rostfritt stål anodiserad	Stainless steel anodized		2000	 6 4 170 83 0 245 9 7
E24L STA 3	RST-anodisoitu	Rostfritt stål anodiserad	Stainless steel anodized		3000	 6 4 170 83 0 245 8 0

**teippikiinnityksellä**  
med tejpmontering  
with tape fastening

**PÄÄTELISTAT**  
AVSLUTNINGSLISTER  
FINISHING PROFILES



25 x 12 mm Tarrapäätelista esimerkiksi kynnyksen ja parketin liikuntasamaan  
Avslutningsprofiler för trösklar och parkett  
Finishing profiles for thresholds and parquet

TUOTENRO PRODUKTNR PRODUCT NO	VÄRI	FÄRG	COLOUR		PITUUS LÄNGD LENGTH	EAN-KOODI EAN-KOD EAN-CODE
E35 CBL1	Carbon black	Carbon black	Carbon black		1000	 6 4 17083 03 1373
E35 CBL2	Carbon black	Carbon black	Carbon black		2000	 6 4 17083 03 1380
E35 CBL3	Carbon black	Carbon black	Carbon black		3000	 6 4 17083 03 1397
E35 HE1	Hopea-anodisoitu	Silver anodiserad	Silver anodized		1000	 6 4 17083 02 2982
E35 HE2	Hopea-anodisoitu	Silver anodiserad	Silver anodized		2000	 6 4 17083 02 2999
E35 HE3	Hopea-anodisoitu	Silver anodiserad	Silver anodized		3000	 6 4 17083 03 1410
E35 NG1	Nordic Graphite	Nordic Graphite	Nordic Graphite		1000	 6 4 17083 03 1342
E35 NG2	Nordic Graphite	Nordic Graphite	Nordic Graphite		2000	 6 4 17083 03 1359
E35 NG3	Nordic Graphite	Nordic Graphite	Nordic Graphite		3000	 6 4 17083 03 1366

 **Nordic Graphite** -värisävy saattaa vaihdella valmistuksessa käytettävän harjaustekniikan vuoksi.  
Nyansen **Nordic Graphite** kan variera beroende på den borstningsteknik som används vid tillverkningen.  
The **Nordic Graphite** shade may vary according to the brushing technique used in manufacturing.

**PÄÄTELISTAT**  
**AVSLUTNINGSLISTER**  
 FINISHING PROFILES

**teippikiinnityksellä**  
**med tejpmontering**  
 with tape fastening

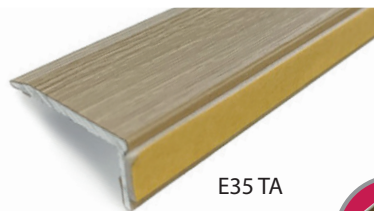
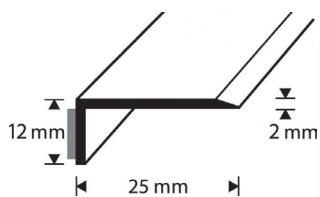

E35 TA

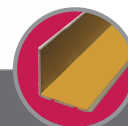

25 x 12 mm Tarrapäätelista kynnyksen ja parketin liikuntasamaan | Puukuvioitu  
 Avslutningsprofiler för trösklar och parkett | Träimitation  
 Finishing profiles for thresholds and parquet | Wood imitation

TUOTENRO PRODUKTNR PRODUCT NO	VÄRI	FÄRG	COLOUR		PITUUS LÄNGD LENGTH	EAN-KOODI EAN-KOD EAN-CODE
E35 ANO1	Aged Nordic Oak	Aged Nordic Oak	Aged Nordic Oak		1000	6 417083 043765
E35 ANO2	Aged Nordic Oak	Aged Nordic Oak	Aged Nordic Oak		2000	6 417083 043772
E35 ANO3	Aged Nordic Oak	Aged Nordic Oak	Aged Nordic Oak		3000	6 417083 043789
E35 NOA1	Natural Oak	Natural Oak	Natural Oak		1000	6 417083 043796
E35 NOA2	Natural Oak	Natural Oak	Natural Oak		2000	6 417083 043802
E35 NOA3	Natural Oak	Natural Oak	Natural Oak		3000	6 417083 042867
E35 TA1	Tammi	Ek	Oak		1000	6 417083 023422
E35 TA2	Tammi	Ek	Oak		2000	6 417083 023439
E35 TA3	Tammi	Ek	Oak		3000	6 417083 026379

**teippikiinnityksellä**  
med tejpmontering  
with tape fastening

**PÄÄTELISTAT**  
AVSLUTNINGSLISTER  
FINISHING PROFILES

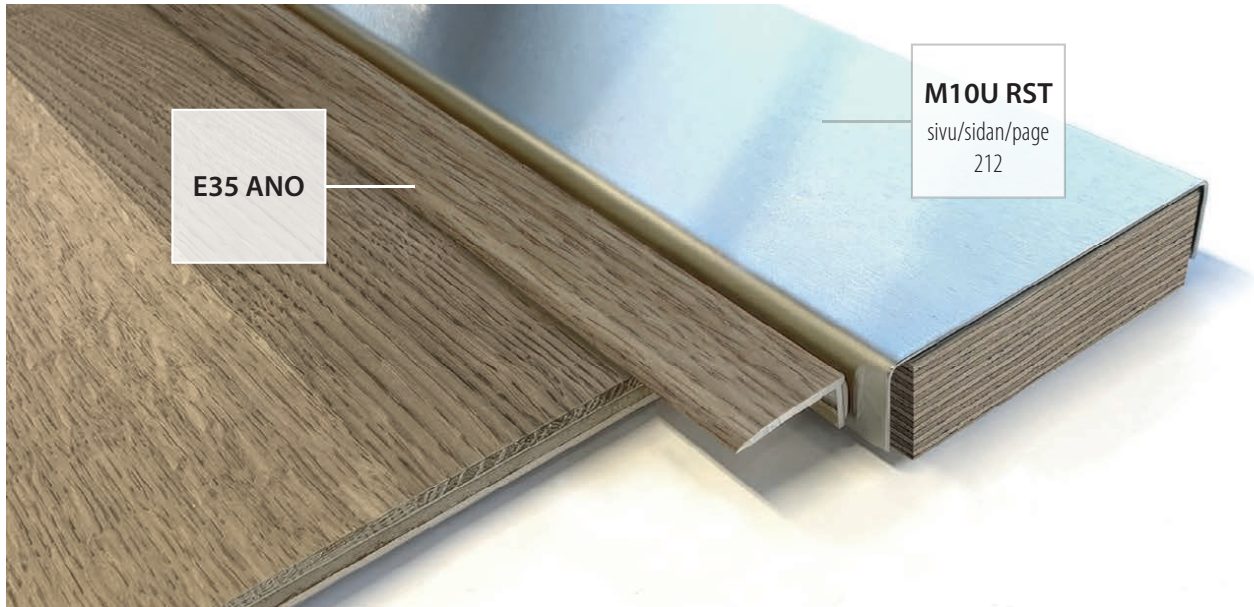

**Dione E35-tarrapäätelista** on helppo ja käytännöllinen ratkaisu kynnyksen ja lattian liitokseen. Metallisävyiset ja puukuosiset päätelistat asennetaan kynnyksen reunaan kaksipuoleisella teippikiinnityksellä, jolloin lattiamateriaaleille jää liikuntavaraa.



**Dione E35 självhäftande avslutningsprofil** är en enkel och praktisk lösning för övergången mellan tröskel och golv. Avslutningsprofiler i metallfärger och träimitation monteras på tröskelkanten med dubbelhäftande tejp, vilket ger golvmaterialen nödvändig rörelsefrihet.



**Dione E35 self-adhesive finishing profile** is an easy and practical solution for connecting thresholds and floor surfaces. Available in metallic finishes and wood imitations, the finishing profiles are installed on the edge of the threshold using double-sided tape, which allows sufficient movement space for the flooring materials.

**PÄÄTELISTAT**  
**AVSLUTNINGSLISTER**  
 FINISHING PROFILES



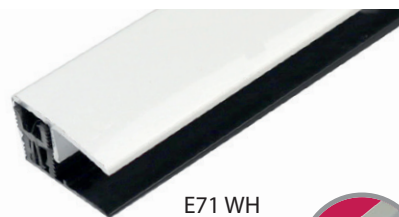
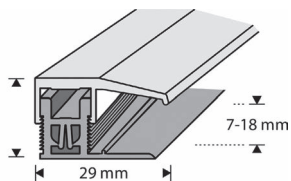



**alakiskokiinnityksellä**  
 med underskena  
 with underrail



E71 WH



29 x 7–18 mm Päätelista alakiskokiinnityksellä laminaatille ja parketille  
 Avslutningsprofil med underskena för träsklar och parkett  
 Finishing profile with underrail for laminate and parquet



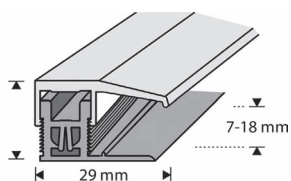

TUOTENRO PRODUKTNR PRODUCT NO	VÄRI	FÄRG	COLOUR		PITUUS LÄNGD LENGTH	EAN-KOODI EAN-KOD EAN-CODE
E71 NG 270	Nordic Graphite	Nordic Graphite	Nordic Graphite		2700	 6 417 083 022548
E71 SI 270	Hopea-anodisoitu	Silver anodiserad	Silver anodized		2700	 6 417 083 021206
E71 WH 270	Maalattu valkoinen	Vitmålad	Painted white		2700	 6 417 083 022555



E71 CW



29 x 7–18 mm Päätelista alakiskokiinnityksellä laminaatille ja parketille | Puukuvioitu  
 Avslutningsprofil med underskena för träsklar och parkett | Träimitation  
 Finishing profile with underrail for laminate and parquet | Wood imitation



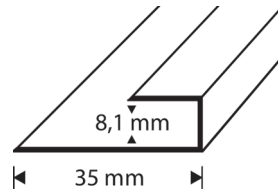

TUOTENRO PRODUKTNR PRODUCT NO	VÄRI	FÄRG	COLOUR		PITUUS LÄNGD LENGTH	EAN-KOODI EAN-KOD EAN-CODE
E71 CW 270	Cotton white	Cotton white	Cotton white		2700	 6 417 083 022562
E71 LO 270	Harmaa tammi	Ljus ek	Light oak		2700	 6 417 083 022579
E71 TA 270	Tammi	Ek	Oak		2700	 6 417 083 022586

**ruuvikiinnityksellä**  
med skruvmontering  
with screw fastening

**PÄÄTELISTAT**  
AVSLUTNINGSLISTER  
FINISHING PROFILES



35 x 8,1 mm Päätelista laminaatille | Avslutningsprofil för laminat  
Finishing profile for laminate

TUOTENRO PRODUKTNR PRODUCT NO	VÄRI	FÄRG	COLOUR		PITUUS LÄNGD LENGTH	EAN-KOODI EAN-KOD EAN-CODE
C5 PE1	Pronssi-anodisoitu	Brons anodiserad	Bronze anodized		1000	 6 4 17083 351631
C5 PE2	Pronssi-anodisoitu	Brons anodiserad	Bronze anodizevd		2000	 6 4 17083 351624

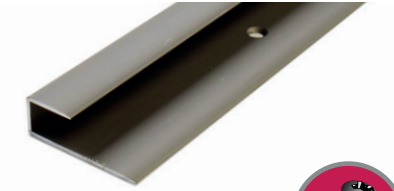
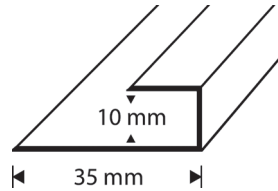

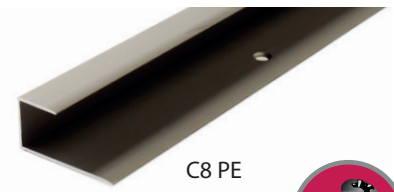
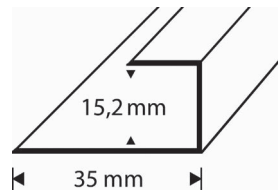

35 x 10 mm Päätelista laminaatille | Avslutningsprofil för laminat  
Finishing profile for laminate

TUOTENRO PRODUKTNR PRODUCT NO	VÄRI	FÄRG	COLOUR		PITUUS LÄNGD LENGTH	EAN-KOODI EAN-KOD EAN-CODE
C6 PE2	Pronssi-anodisoitu	Brons anodiserad	Bronze anodized		2000	 6 4 17083 361623



35x 15,2 mm Päätelista laminaatille | Avslutningsprofil för laminat  
Finishing profile for laminate

TUOTENRO PRODUKTNR PRODUCT NO	VÄRI	FÄRG	COLOUR		PITUUS LÄNGD LENGTH	EAN-KOODI EAN-KOD EAN-CODE
C8 HE2	Hopea-anodisoitu	Silver anodiserad	Silver anodized		2000	 6 4 17083 381324
C8 PE1	Pronssi-anodisoitu	Brons anodiserad	Bronze anodized		1000	 6 4 17083 381638
C8 PE2	Pronssi-anodisoitu	Brons anodiserad	Bronze anodized		2000	 6 4 17083 381621

**PÄÄTELISTAT**  
**AVSLUTNINGSLISTER**  
**FINISHING PROFILES**

**ruuvi- tai liimakiinnityksellä**  
**med skruv eller lim-montering**  
**with screw or glue fastening**

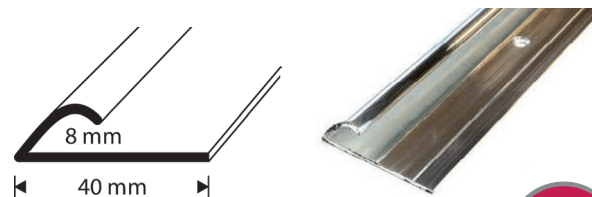

40 x 8 mm Tekstiliimatoille | För mattor | For carpets



TUOTENRO PRODUKTNR PRODUCT NO	VÄRI	FÄRG	COLOUR		PITUUS LÄNGD LENGTH	EAN-KOODI EAN-KOD EAN-CODE
7791501	Alumiini	Aluminium	Aluminium		2700	6 417083 915017

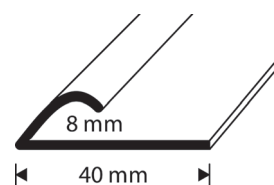

40 x 8 mm Tekstiliimatoille | För mattor | For carpets

TUOTENRO PRODUKTNR PRODUCT NO	VÄRI	FÄRG	COLOUR		PITUUS LÄNGD LENGTH	EAN-KOODI EAN-KOD EAN-CODE
7791502-R	Hopea-anodisoitu	Silver anodiserad	Silver anodized		2700	6 417083 019814

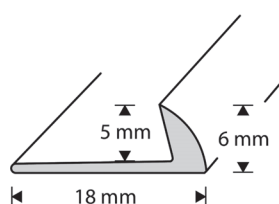

H=5 mm Päätelista vinyylilankuille | Avslutningsprofil för vinyl | Finishing profile for vinyl

TUOTENRO PRODUKTNR PRODUCT NO	VÄRI	FÄRG	COLOUR		PITUUS LÄNGD LENGTH	EAN-KOODI EAN-KOD EAN-CODE
P5 HE	Hopea-anodisoitu	Silver anodiserad	Silver anodized		2700	6 417083 020865
P5 KR	Kromi-anodisoitu	Krom anodiserad	Chrome anodized		2700	6 417083 020858

# JALKALISTAT SOCKLAR SKIRTINGS

## ANNA SISUSTUKSELLE HUOLITeltu JA RYHDIKÄS ILME.

Lisää lattioille viehättävä loppusilaus jalkalistoilla. Kestävät ja kevyet alumiiniset jalkalistat istuvat modernin sisustustyyliin ja RST-jalkalistat kestävät kovaakin kulutusta. Laadukkaat Dione-jalkalistat ovat pitkäikäisiä eivätkä kaipaa ylläpitoa.

Muovisten jalkalistojen valikoimassamme on tuotteita, jotka on suunniteltu niin suojaamaan askelkulumia ja seinien ulkokulmia kuin yhdistämään erilaisia lattiamateriaaleja ja viimeistelemään suihkutiloja. Liimakiinnitteisten listojen asentaminen on nopeaa ja helppoa.

## GER INREDNINGEN ETT VÅRDAT OCH GEDIGET UTSEENDE.

Socklar ger golven en tilltalande slutfinish. Hållbara och lätta aluminiumsocklar passar särskilt bra i moderna inredningar och RST-socklarna är mycket slitagestarka. De högkvalitativa Dione-socklarna har lång hållbarhet och är underhållsfria.

Vårt sortiment med plastsocklar innefattar produkter som är särskilt avsedda för att skydda trappkanter och yttre vägghörn samt för att kombinera olika golvmaterial och ge duschrum en slutlig finish. Listerna monteras snabbt och enkelt med lim.

## ADD AN APPEALING FINISHING TOUCH TO YOUR FLOORING.

Skirtings are an easy way to add character to your floor. Durable and light weight aluminium skirtings are well suited for a modern decor and stainless steel skirtings offer exceptional durability. High-quality Dione skirtings are long lasting and maintenance free.

Our assortment of plastic skirtings includes products designed to protect stair nosings and external corners in walls as well as join together different flooring materials and give a stylish finish to wet rooms. The profiles are quick and easy to install with glue.

# JALKALISTAT SOCKLAR SKIRTINGS

metalliset  
av metall  
metal

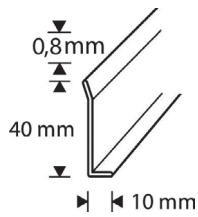

JLRST 40 HI 0,8

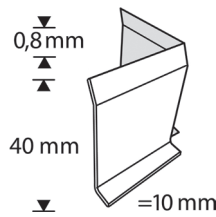

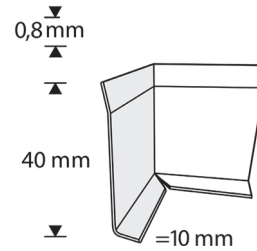

JL40EC RST



JL40IC RST



## 40 x 10 mm RST | Rostfritt stål | Stainless steel

TUOTENRO PRODUKTNR PRODUCT NO	TUOTE PRODUKT PRODUCT	VÄRI	FÄRG	COLOUR		PITUUS LÄNGD LENGTH	EAN-KOODI EAN-KOD EAN-CODE
JLRST 40 HI 0,8	Jalkalista Golvsockel Skirting	RST	Rostfritt stål	Stainless steel		3000	 6 417 083 040085
JL40EC RST	Ulkokulma Ytterhörn Outer corner	RST	Rostfritt stål	Stainless steel		-	 6 417 083 060786
JL40IC RST	Sisäkulma Innerhörn Inner corner	RST	Rostfritt stål	Stainless steel		-	 6 417 083 060793

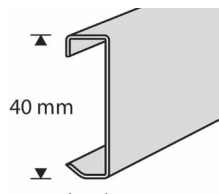

JLRST 40-JOHTO

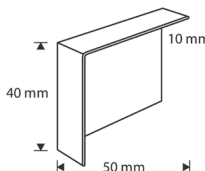

RST-JOHTO O

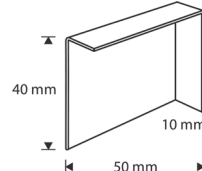



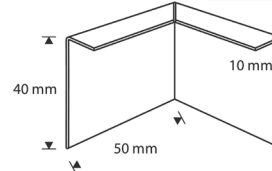





RST-JOHTO V



RST-JOHTO U



## 40 mm Johtojalkalista, RST | Kabel golvsockel, rostfritt stål | Cable skirting, stainless steel Klipsikiinnitys | Clip montering | Clip fastening

TUOTENRO PRODUKTNR PRODUCT NO	TUOTE PRODUKT PRODUCT	VÄRI	FÄRG	COLOUR		PITUUS LÄNGD LENGTH	EAN-KOODI EAN-KOD EAN-CODE
JLRST 40-JOHTO	Jalkalista Golvsockel Skirting	RST	Rostfritt stål	Stainless steel		3000	 6 417 083 042089
RST-JOHTO O	Oikea päättyala Ändstycke höger Right end piece	RST	Rostfritt stål	Stainless steel		-	 6 417 083 042058
RST-JOHTO V	Vasen päättyala Ändstycke vänster Left end piece	RST	Rostfritt stål	Stainless steel		-	 6 417 083 042065
RST-JOHTO U	Ulkokulma Hörnstycke Outer corner	RST	Rostfritt stål	Stainless steel		-	 6 417 083 042072

**metalliset**  
av metall  
metal

**JALKALISTAT**  
SOCKLAR  
SKIRTINGS

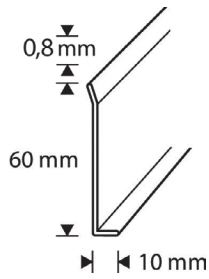

JLRST 60 HI 0,8

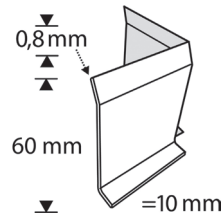

JL60EC RST

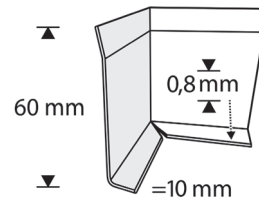

JL60IC RST



60 x 10 mm RST | Rostfritt stål | Stainless steel

TUOTENRO PRODUKTNR PRODUCT NO	TUOTE PRODUKT PRODUCT	VÄRI	FÄRG	COLOUR		PITUUS LÄNGD LENGTH	EAN-KOODI EAN-KOD EAN-CODE
JLRST 60 HI 0,8	Jalkalista Golvsockel Skirting	RST	Rostfritt stål	Stainless steel		3000	 6 4 17083 060083
JL60EC RST	Ulkokulma Ytterhörn Outer corner	RST	Rostfritt stål	Stainless steel		-	 6 4 17083 060762
JL60IC RST	Sisäkulma Innerhörn Inner corner	RST	Rostfritt stål	Stainless steel		-	 6 4 17083 060779

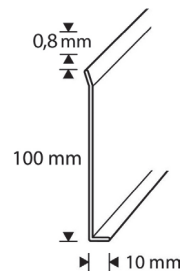

100 x 10 mm RST | Rostfritt stål | Stainless steel

TUOTENRO PRODUKTNR PRODUCT NO	VÄRI	FÄRG	COLOUR		PITUUS LÄNGD LENGTH	EAN-KOODI EAN-KOD EAN-CODE
JLRST 100 HI 0,8	RST	Rostfritt stål	Stainless steel		3000	 6 4 17083 060090



**MITTATILAUSTRUOTTEET**

Jalkalistat tilauksesta myös messinkisenä



**MÅTTBESTÄLLDA PRODUKTER**

Golvsocklar på beställning även i mässing



**CUSTOM-MADE PRODUCTS**

Skirtings available to order also in brass

# JALKALISTAT

## SOCKLAR

### SKIRTINGS

metalliset  
av metall  
metal

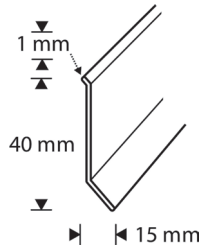
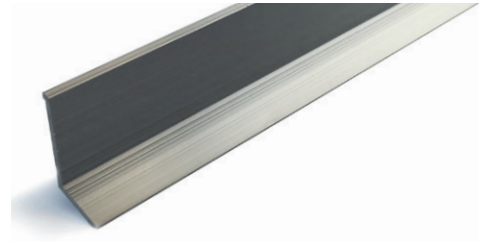

JL AS 40

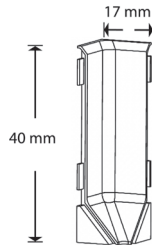

IC-40 AS

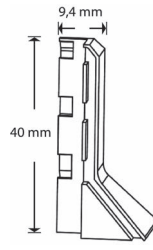

OC-40 AS

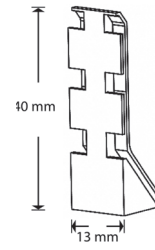



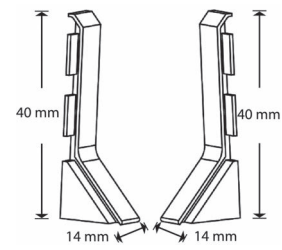



JP-40 AS



EC-40 AS L / EC-40 AS R

#### 40 x 15 mm Alumiini | Aluminium | Aluminium



TUOTENRO PRODUKTNR PRODUCT NO	TUOTE PRODUKT PRODUCT	VÄRI	FÄRG	COLOUR		PITUUS LÄNGD LENGTH	EAN-KOODI EAN-KOD EAN-CODE
JL AS 40	Jalkalista Golvsockel Skirting	RST- anodisoitu	Rostfritt stål anodiserad	Stainless steel anodized		3000	 6 417 083 040034
IC-40 AS	Sisäkulma Innerhorn Inner corner	RST- anodisoitu	Rostfritt stål anodiserad	Stainless steel anodized		-	 6 417 083 038914
OC-40 AS	Ulkukulma Ytterhorn Outer corner	RST- anodisoitu	Rostfritt stål anodiserad	Stainless steel anodized		-	 6 417 083 039409
JP-40 AS	Jatkokappale Fortsättningsstycke Joint piece	RST- anodisoitu	Rostfritt stål anodiserad	Stainless steel anodized		-	 6 417 083 039096
EC-40 AS L	Päätypala vasen Ändstycke vänster Endcap left	RST- anodisoitu	Rostfritt stål anodiserad	Stainless steel anodized		-	 6 417 083 039669
EC-40 AS R	Päätypala oikea Ändstycke höger Endcap right	RST- anodisoitu	Rostfritt stål anodiserad	Stainless steel anodized		-	 6 417 083 039690

metalliset  
av metall  
metal

JALKALISTAT  
SOCKLAR  
SKIRTINGS

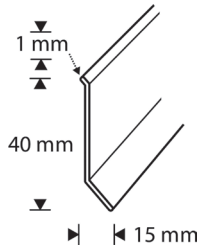

JL NG 40

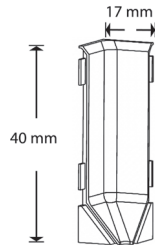

IC-40 NG

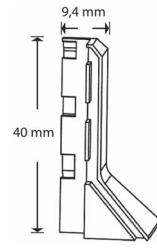

OC-40 NG

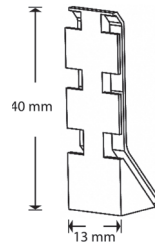



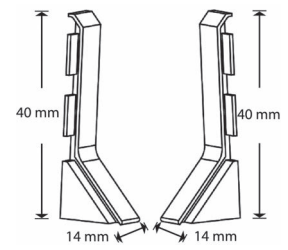



JP-40 NG



EC-40 NG L / EC-40 NG R



40 x 15 mm Alumiini | Aluminium | Aluminium

TUOTENRO PRODUKTNR PRODUCT NO	TUOTE PRODUKT PRODUCT	VÄRI	FÄRG	COLOUR		PITUUS LÄNGD LENGTH	EAN-KOODI EAN-KOD EAN-CODE
JL NG 40	Jalkalista Golvsockel Skirting	Nordic Graphite	Nordic Graphite	Nordic Graphite		3000	 6 4 17083 040078
IC-40 NG	Sisäkulma Innerhörn Inner corner	Nordic Graphite	Nordic Graphite	Nordic Graphite		-	 6 4 17083 038921
OC-40 NG	Ulkukulma Ytterhörn Outer corner	Nordic Graphite	Nordic Graphite	Nordic Graphite		-	 6 4 17083 039416
JP-40 NG	Jatkokappale Fortsättningsstycke Joint piece	Nordic Graphite	Nordic Graphite	Nordic Graphite		-	 6 4 17083 039102
EC-40 NG L	Päätypala vasen Ändstycke vänster Endcap left	Nordic Graphite	Nordic Graphite	Nordic Graphite		-	 6 4 17083 039676
EC-40 NG R	Päätypala oikea Ändstycke höger Endcap right	Nordic Graphite	Nordic Graphite	Nordic Graphite		-	 6 4 17083 039706

**Nordic Graphite** -värisävy saattaa vaihdella valmistuksessa käytettävän harjaustekniikan vuoksi.  
Nyansen **Nordic Graphite** kan variera beroende på den borstningsteknik som används vid tillverkningen.  
The **Nordic Graphite** shade may vary according to the brushing technique used in manufacturing.

# JALKALISTAT

## SOCKLAR

### SKIRTINGS

metalliset  
av metall  
metal

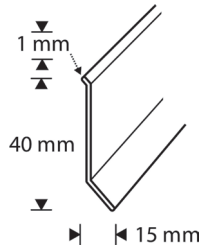

JL SI 40

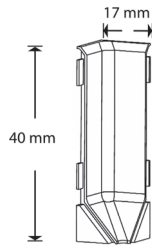

IC-40 SI

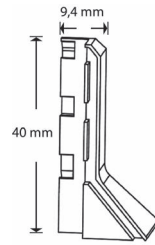

OC-40 SI

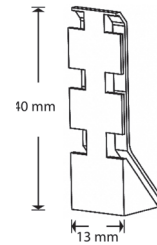



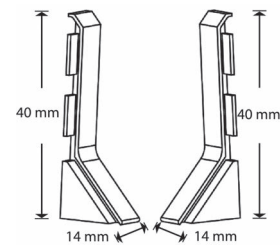



JP-40 SI



EC-40 SI L / EC-40 SI R



#### 40 x 15 mm Alumiini | Aluminium | Aluminium

TUOTENRO PRODUKTNR PRODUCT NO	TUOTE PRODUKT PRODUCT	VÄRI	FÄRG	COLOUR		PITUUS LÄNGD LENGTH	EAN-KOODI EAN-KOD EAN-CODE
JL SI 40	Jalkalista Golvsockel Skirting	Hopea- anodisoitu	Silver anodiserad	Silver anodized		3000	 6 417 083 040023
IC-40 SI	Sisäkulma Innerhörn Inner corner	Hopea- anodisoitu	Silver anodiserad	Silver anodized		-	 6 417 083 038938
OC-40 SI	Ulkukulma Ytterhörn Outer corner	Hopea- anodisoitu	Silver anodiserad	Silver anodized		-	 6 417 083 039423
JP-40 SI	Jatkokappale Fortsättningsstycke Joint piece	Hopea- anodisoitu	Silver anodiserad	Silver anodized		-	 6 417 083 039119
EC-40 SI L	Päätypala vasen Ändstycke vänster Endcap left	Hopea- anodisoitu	Silver anodiserad	Silver anodized		-	 6 417 083 039683
EC-40 SI R	Päätypala oikea Ändstycke höger Endcap right	Hopea- anodisoitu	Silver anodiserad	Silver anodized		-	 6 417 083 039713

metalliset  
av metall  
metal

JALKALISTAT  
SOCKLAR  
SKIRTINGS

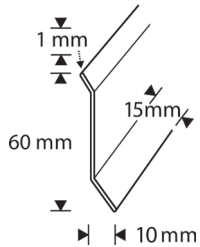

JL AS 60

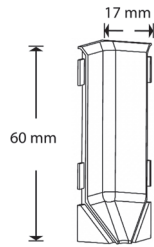

IC-60 AS

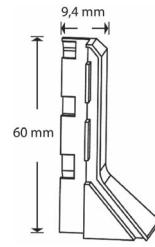

OC-60 AS

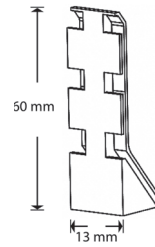



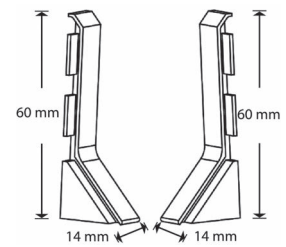



JP-60 AS



EC-60 AS L / EC-60 AS R



60 x 15 mm Alumiini | Aluminium | Aluminium

TUOTENRO PRODUKTNR PRODUCT NO	TUOTE PRODUKT PRODUCT	VÄRI	FÄRG	COLOUR		PITUUS LÄNGD LENGTH	EAN-KOODI EAN-KOD EAN-CODE
JL AS 60	Jalkalista Golvsockel Skirting	RST- anodisoitu	Rostfritt stål anodiserad	Stainless steel anodized		3000	 6 4 17083 060052
IC-60 AS	Sisäkulma Innerhörn Inner corner	RST- anodisoitu	Rostfritt stål anodiserad	Stainless steel anodized		-	 6 4 17083 038945
OC-60 AS	Ulkukulma Ytterhörn Outer corner	RST- anodisoitu	Rostfritt stål anodiserad	Stainless steel anodized		-	 6 4 17083 039430
JP-60 AS	Jatkokappale Fortsättningsstycke Joint piece	RST- anodisoitu	Rostfritt stål anodiserad	Stainless steel anodized		-	 6 4 17083 039126
EC-60 AS L	Päätypala vasen Ändstycke vänster Endcap left	RST- anodisoitu	Rostfritt stål anodiserad	Stainless steel anodized		-	 6 4 17083 039720
EC-60 AS R	Päätypala oikea Ändstycke höger Endcap right	RST- anodisoitu	Rostfritt stål anodiserad	Stainless steel anodized		-	 6 4 17083 039645

# JALKALISTAT SOCKLAR SKIRTINGS

metalliset  
av metall  
metal

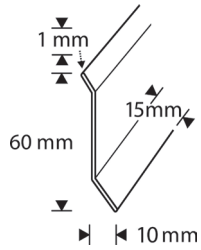
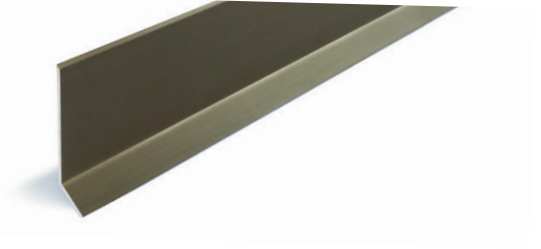

JL NG 60

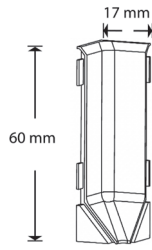

IC-60 NG

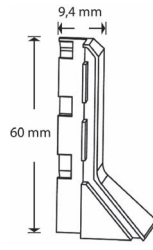

OC-60 NG

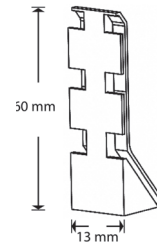

JP-60 NG

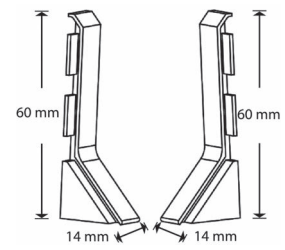

EC-60 NG L / EC-60 NG R

## 60 x 15 mm Alumiini | Aluminium | Aluminium



TUOTENRO PRODUKTNR PRODUCT NO	TUOTE PRODUKT PRODUCT	VÄRI	FÄRG	COLOUR		PITUUS LÄNGD LENGTH	EAN-KOODI EAN-KOD EAN-CODE
JL NG 60	Jalkalista Golvsockel Skirting	Nordic Graphite	Nordic Graphite	Nordic Graphite		3000	6 417 083 060076
IC-60 NG	Sisäkulma Innerhörn Inner corner	Nordic Graphite	Nordic Graphite	Nordic Graphite		-	6 417 083 038952
OC-60 NG	Ulkukulma Ytterhörn Outer corner	Nordic Graphite	Nordic Graphite	Nordic Graphite		-	6 417 083 039447
JP-60 NG	Jatkokappale Fortsättningsstycke Joint piece	Nordic Graphite	Nordic Graphite	Nordic Graphite		-	6 417 083 039133
EC-60 NG L	Päätypala vasen Ändstycke vänster Endcap left	Nordic Graphite	Nordic Graphite	Nordic Graphite		-	6 417 083 039133
EC-60 NG R	Päätypala oikea Ändstycke höger Endcap right	Nordic Graphite	Nordic Graphite	Nordic Graphite		-	6 417 083 039645

**Nordic Graphite** -värisävy saattaa vaihdella valmistuksessa käytettävän harjaustekniikan vuoksi.  
Nyansen **Nordic Graphite** kan variera beroende på den borstningsteknik som används vid tillverkningen.  
The **Nordic Graphite** shade may vary according to the brushing technique used in manufacturing.

metalliset  
av metall  
metal

JALKALISTAT  
SOCKLAR  
SKIRTINGS

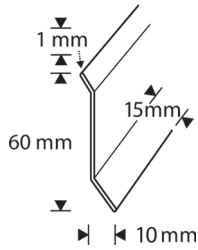

JL SI 60

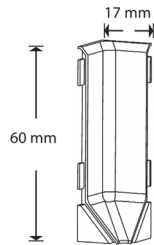

IC-60 SI

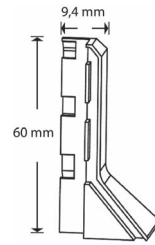

OC-60 SI

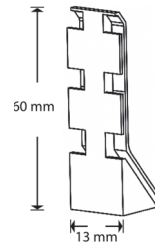



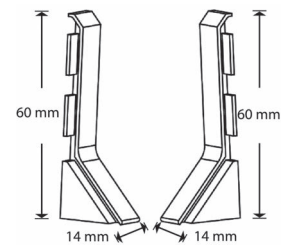



JP-60 SI



EC-60 SI L / EC-60 SI R



60 x 15 mm Alumiini | Aluminium | Aluminium

TUOTENRO PRODUKTNR PRODUCT NO	TUOTE PRODUKT PRODUCT	VÄRI	FÄRG	COLOUR		PITUUS LÄNGD LENGTH	EAN-KOODI EAN-KOD EAN-CODE
JL SI 60	Jalkalista Golvsockel Skirting	Hopea- anodisoitu	Silver anodiserad	Silver anodized		3000	 6 4 17083 060021
IC-60 SI	Sisäkulma Innerhörn Inner corner	Hopea- anodisoitu	Silver anodiserad	Silver anodized		-	 6 4 17083 038969
OC-60 SI	Ulkukulma Ytterhörn Outer corner	Hopea- anodisoitu	Silver anodiserad	Silver anodized		-	 6 4 17083 039454
JP-60 SI	Jatkokappale Fortsättningsstycke Joint piece	Hopea- anodisoitu	Silver anodiserad	Silver anodized		-	 6 4 17083 039140
EC-60 SI L	Päätypala vasen Ändstycke vänster Endcap left	Hopea- anodisoitu	Silver anodiserad	Silver anodized		-	 6 4 17083 039638
EC-60 SI R	Päätypala oikea Ändstycke höger Endcap right	Hopea- anodisoitu	Silver anodiserad	Silver anodized		-	 6 4 17083 040153

**JALKALISTAT**  
SOCKLAR  
SKIRTINGS

**muoviset**  
av plast  
plastic

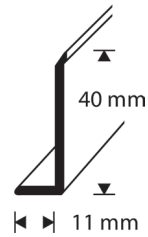

JL 40-470



40 mm Muovi | Plast | Plastic

TUOTENRO PRODUKTNR PRODUCT NO	VÄRI	FÄRG	COLOUR		PITUUS LÄNGD LENGTH	EAN-KOODI EAN-KOD EAN-CODE
JL 40-103	Tummanruskea	Mörk brun	Dark brown		50 m	 6 417 083 041037
JL 40-410	Valkoinen	Vit	White		50 m	 6 417 083 044106
JL 40-411	Valkoharmaa	Vitgrå	White grey		50 m	 6 417 083 042478
JL 40-412	Vaaleanharmaa	Ljus grå	Light grey		50 m	 6 417 083 044120
JL 40-414	Keskiharmaa	Grå	Grey		50 m	 6 417 083 044144
JL 40-418	Tummanharmaa	Mörk grå	Dark grey		50 m	 6 417 083 044182
JL 40-420	Beige	Beige	Beige		50 m	 6 417 083 044205
JL 40-470	Musta	Svart	Black		50 m	 6 417 083 044700

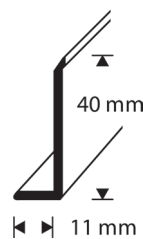

JL 40T-412

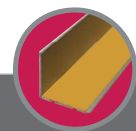

40 mm Muovi, teippikiinnitys | Plast, tejp montering | Plastic, tape fastening

TUOTENRO PRODUKTNR PRODUCT NO	VÄRI	FÄRG	COLOUR		PITUUS LÄNGD LENGTH	EAN-KOODI EAN-KOD EAN-CODE
JL 40T-410	Valkoinen	Vit	White		50 m	 6 417 083 042553
JL 40T-412	Vaaleanharmaa	Ljus grå	Light grey		50 m	 6 417 083 042546
JL 40T-418	Tummanharmaa	Mörk grå	Dark grey		50 m	 6 417 083 042539
JL 40T-470	Musta	Svart	Black		50 m	 6 417 083 042522

**muoviset**  
av plast  
plastic



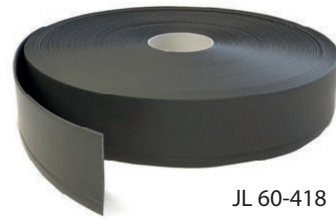
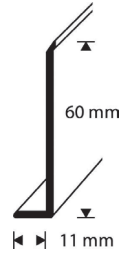













**JALKALISTAT**  
**SOCKLAR**  
**SKIRTINGS**



JL 60-418



60 mm Muovi | Plast | Plastic



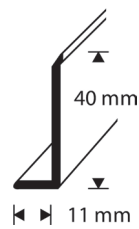



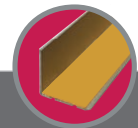

TUOTENRO PRODUKTNR PRODUCT NO	VÄRI	FÄRG	COLOUR		PITUUS LÄNGD LENGTH	EAN-KOODI EAN-KOD EAN-CODE
JL 60-103	Tummanruskea	Mörk brun	Dark brown		50 m	 6 4 17083 061035
JL 60-410	Valkoinen	Vit	White		50 m	 6 4 17083 064104
JL 60-411	Valkoharmaa	Vitgrå	White grey		50 m	 6 4 17083 042485
JL 60-412	Vaaleanharmaa	Ljus grå	Light grey		50 m	 6 4 17083 064128
JL 60-414	Keskiharmaa	Grå	Grey		50 m	 6 4 17083 064142
JL 60-418	Tummanharmaa	Mörk grå	Dark grey		50 m	 6 4 17083 064180
JL 60-420	Beige	Beige	Beige		50 m	 6 4 17083 064203
JL 60-470	Musta	Svart	Black		50 m	 6 4 17083 064708



JL 60T-410



60 mm Muovi, teippikiinnitys | Plast, tejp montering | Plastic, tape fastening

TUOTENRO PRODUKTNR PRODUCT NO	VÄRI	FÄRG	COLOUR		PITUUS LÄNGD LENGTH	EAN-KOODI EAN-KOD EAN-CODE
JL 60T-410	Valkoinen	Vit	White		50 m	 6 4 17083 042591
JL 60T-412	Vaaleanharmaa	Ljus grå	Light grey		50 m	 6 4 17083 042584
JL 60T-418	Tummanharmaa	Mörk grå	Dark grey		50 m	 6 4 17083 042577
JL 60T-470	Musta	Svart	Black		50 m	 6 4 17083 042560

**JALKALISTAT**  
SOCKLAR  
SKIRTINGS

**muoviset**  
av plast  
plastic

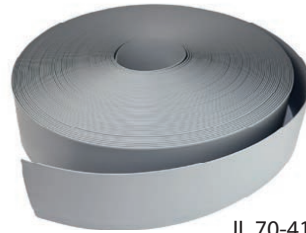
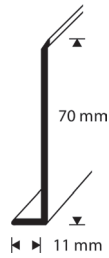

JL 70-412



70 mm Muovi | Plast | Plastic

TUOTENRO PRODUKTNR PRODUCT NO	VÄRI	FÄRG	COLOUR		PITUUS LÄNGD LENGTH	EAN-KOODI EAN-KOD EAN-CODE
JL 70-410	Valkoinen	Vit	White		50 m	6 417083 074707
JL 70-412	Vaaleanharmaa	Ljus grå	Light grey		50 m	6 417083 074103
JL 70-470	Musta	Svart	Black		50 m	6 417083 074127



JL 100-470



100 mm Muovi | Plast | Plastic

**TILAUSTUOTE | BESTÄLLNINGSVARA | ORDER ONLY PRODUCT**

TUOTENRO PRODUKTNR PRODUCT NO	VÄRI	FÄRG	COLOUR		PITUUS LÄNGD LENGTH	EAN-KOODI EAN-KOD EAN-CODE
JL 100-410	Valkoinen	Vit	White		50 m	6 417083 104107
JL 100-412	Vaaleanharmaa	Ljus grå	Light grey		50 m	6 417083 104121
JL 100-470	Musta	Svart	Black		50 m	6 417083 104701

Listateippi, kaksipuolinen | Golvsockel tejp, dubbelsidig  
Skirting adhesive, double sided

TUOTENRO PRODUKTNR PRODUCT NO	PITUUS/rII LÄNGD/rII LENGTH/roll	LEVEYS BREDD WIDTH	EAN-KOODI EAN-KOD EAN-CODE
JLT 35	51 m	35 mm	6 417083 020315
JLT 55	51 m	55 mm	6 417083 020322



**muoviset**  
av plast  
plastic

**JALKALISTAT**  
**SOCKLAR**  
**SKIRTINGS**



JLP 40-410



40 mm x 10 mm Muovi | Plast | Plastic

TUOTENRO PRODUKTNR PRODUCT NO	VÄRI	FÄRG	COLOUR		PITUUS LÄNGD LENGTH	EAN-KOODI EAN-KOD EAN-CODE
JLP 40-410	Valkoinen	Vit	White		2750	 6 4 17083 024269
JLP 40-411	Valkoharmaa	Vitgrå	White grey		2750	 6 4 17083 042430
JLP 40-412	Vaaleanharmaa	Ljus grå	Light grey		2750	 6 4 17083 024276
JLP 40-418	Tummanharmaa	Mörk grå	Dark grey		2750	 6 4 17083 024283
JLP 40-470	Musta	Svart	Black		2750	 6 4 17083 024290



JLP 60-411



60 mm x 12 mm Muovi | Plast | Plastic

TUOTENRO PRODUKTNR PRODUCT NO	VÄRI	FÄRG	COLOUR		PITUUS LÄNGD LENGTH	EAN-KOODI EAN-KOD EAN-CODE
JLP 60-410	Valkoinen	Vit	White		2750	 6 4 17083 024306
JLP 60-411	Valkoharmaa	Vitgrå	White grey		2750	 6 4 17083 042447
JLP 60-412	Vaalean harmaa	Ljus grå	Light grey		2750	 6 4 17083 024313
JLP 60-418	Tummanharmaa	Mörk grå	Dark grey		2750	 6 4 17083 024320
JLP 60-470	Musta	Svart	Black		2750	 6 4 17083 024337

# KÄSIJOHDELISTAT

## LEDSTÅNGSPROFILER

### HAND RAIL PROFILES

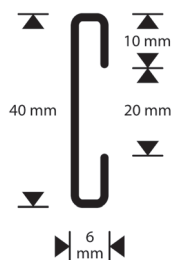

40 x 6 mm Käsi johdelista, muovia | Ledstångsprofil, av plast | Hand rail profile, plastic

TUOTENRO PRODUKTNR PRODUCT NO	VÄRI	FÄRG	COLOUR	PITUUS LÄNGD LENGTH	EAN-KOODI EAN-KOD EAN-CODE
KL 21-470	Musta	Svart	Black	30 m	 6 4 1 7 0 8 3 2 1 4 7 0 7

## PILARINKAULUKSET

### GOLVSOCKLAR FÖR PELARE

#### COLUMN COLLARS



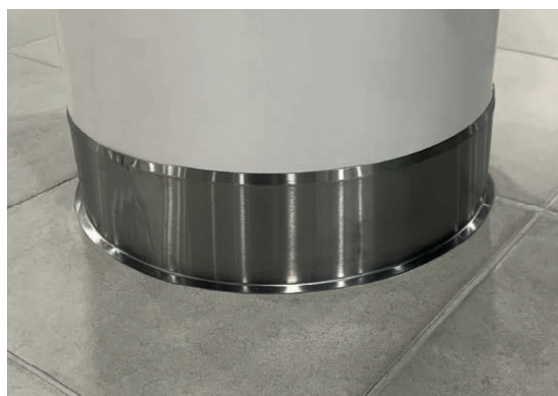

 Pilarinkaulukset valmistetaan julkisiin tiloihin soveltuvasta ruostumattomasta teräksestä tai messingistä. Nykyään niitä käytetään myös yhä enemmän yksityisasunnoissa. Valmistetaan aina tilauksesta ilmoitetun halkaisijan mukaan.

 Golvsocklar för pelare är tillverkad av rostfritt stål eller mässing som är anpassad för offentliga miljöer. Utöver flitig användning i offentliga miljöer används numera golvsocklar även i hemmiljöer. Tillverkas alltid på beställning enligt den angivna diametern.

 Column collars are made of stainless steel or brass suitable for public premises. In addition to public premises, column collars are nowadays also often used at home. Always manufactured on order in accordance with the diameter.



Pilarinkaulukset | Golvsocklar för pelare | Column collars

TUOTENRO PRODUKTNR PRODUCT NO	MITAT MÅTT MEASUREMENTS	EAN-KOODI EAN-KOD EAN CODE
JLRST 300	yli Ø 200 mm, korkeudet 40–150 mm, hiottu RST, 2-osainen över Ø 200 mm, höjd 40–150 mm, slipat rostfritt stål, 2 delar more than Ø 200 mm, height 40–150 mm, ground stainless steel, 2-part	 6 4 1 7 0 8 3 0 1 8 5 7 2
JLMS 300	yli Ø 200 mm, korkeudet 40–150 mm, hiottu messinki, 2-osainen över Ø 200 mm, höjd 40–150 mm, slipat mässing 2 delar more than Ø 200 mm, height 40–150 mm, ground brass, 2-part	 6 4 1 7 0 8 3 0 1 8 5 8 9
JLRST 200	yli Ø 200 mm, korkeudet 40–150 mm, hiottu RST, 4-osainen över Ø 200 mm, höjd 40–150 mm, slipat rostfritt stål, 4 delar more than Ø 200 mm, height 40–150 mm, ground stainless steel, 4-part	 6 4 1 7 0 8 3 0 1 8 5 9 6
JLMS 200	yli Ø 200 mm, korkeudet 40–150 mm, hiottu messinki, 4-osainen över Ø 200 mm, höjd 40–150 mm, slipat mässing, 4 delar more than Ø 200 mm, height 40–150 mm, ground brass, 4-part	 6 4 1 7 0 8 3 0 1 8 6 0 2

# KULMASUOJALISTAT HÖRNSKYDDSPROFILER CORNER PROTECTION

## TUO TYYLIÄ JA SUOJAA SEINIEN ULKOKULMIIN.

Metalliset kulmasuojalistat ovat tärkeä osa julkisten tilojen sisustusta ja niille on paikkansa myös yksityisasunnoissa. Listat ovat kestävä ratkaisu kovaan kulutukseen joutuvien kulmien suojaukseen.

Metalliset Dione-kulmasuojalistat valmistetaan kevyestä alumiinista tai RST:stä, ja ne on helppo asentaa tarrasaumatulla Elasticfix-kiinnityksellä.

Seinien ulkokulmien suojaaminen muovisilla kulmasuojalistoilla on tyylikäs tapa varjella asuntoa jokapäiväiseltä kulumiselta. Kovasta muovista valmistettuja listoja on saatavana keveissä, nykytrendien mukaisissa väreissä.

## FINESS OCH SKYDD FÖR YTTRE VÄGGHÖRN.

Hörnskyddsprofiler i metall är en viktig del av inredningen i offentliga utrymmen och används numera även i privata bostäder. De är en slittålig lösning för att täcka hörn som utsätts för kraftigt slitage i vardagen.

Dione-hörnskyddsprofiler i metall är tillverkade av lätt aluminium eller rostfritt stål och är enkla att montera med självhäftande Elasticfix.

Att täcka de yttre vägghörnen med hörnskyddsprofiler i plast är ett elegant sätt att skydda dem mot dagligt slitage. Listerna tillverkas i hård plast och finns i ljusa, moderna färger.

## GIVE STYLE AND PROTECTION TO EXTERNAL CORNERS.

In addition to being a staple at public premises, metal corner protection profiles have their place in private homes too. The profiles offer durable protection for corners that face a lot of daily wear and tear. Dione metal corner protection profiles are made of lightweight aluminium or stainless steel and they are easily installed with self-adhesive Elasticfix fastening.

Covering external wall corners with our plastic profiles is an easy way to stylishly guard against signs of wear. Made of hard PVC plastic, the profiles are available in light, modern colours.

**KULMASUOJALISTAT**  
**HÖRNSKYDDSPROFILER**  
 CORNER PROTECTION

**metalliset**  
 av metall  
 metal

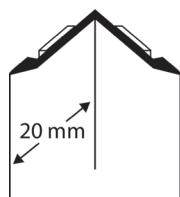

20 x 20 mm Sisäkulmasuojalista | Innerhörnlist | Inside corner trim | ELASTICFIX

TUOTENRO PRODUKTNR PRODUCT NO	VÄRI	FÄRG	COLOUR		PITUUS LÄNGD LENGTH	EAN-KOODI EAN-KOD EAN-CODE
7433032	Hopea-anodisoitu	Silver anodiserad	Silver anodized		2700	 6 417 083 743306

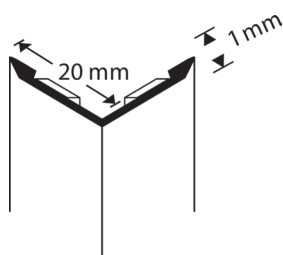

20 x 20 mm Kulmasuojalista | Hörnskyddsprofil | Corner protection | ELASTICFIX

TUOTENRO PRODUKTNR PRODUCT NO	VÄRI	FÄRG	COLOUR		PITUUS LÄNGD LENGTH	EAN-KOODI EAN-KOD EAN-CODE
7333032	Hopea-anodisoitu	Silver anodiserad	Silver anodized		3000	 6 417 083 333033
B20 NG3	Nordic Graphite	Nordic Graphite	Nordic Graphite		3000	 6 417 083 031403
B20 RST 3	RST	Rostfritt stål	Stainless steel		3000	 6 417 083 027871
7300135	RST, kiiltohehkutettu	Rostfritt stål	Stainless steel, brilliant		3000	 6 417 083 001352

**Nordic Graphite** -värisävy saattaa vaihdella valmistuksessa käytettävän harjaustekniikan vuoksi.  
 Nyanssen **Nordic Graphite** kan variera beroende på den borstningsteknik som används vid tillverkningen.  
 The **Nordic Graphite** shade may vary according to the brushing technique used in manufacturing.

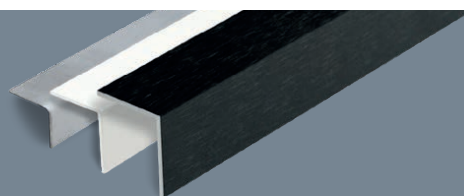



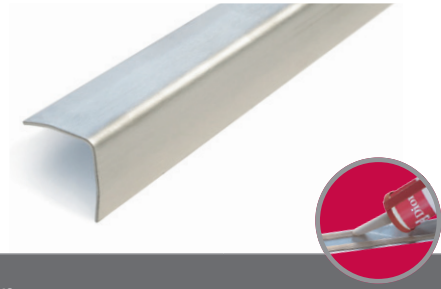
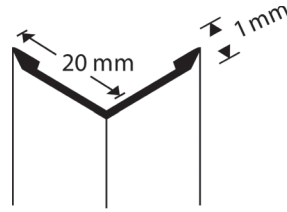

**Katso myös Hobby L-listat** sivu 235  
**Se också Hobby L-profiler** sidan 235  
**See also Hobby L profiles** page 235

metalliset  
av metall  
metal

KULMASUOJALISTAT  
HÖRNSKYDDSPROFILER  
CORNER PROTECTION



20 x 20 mm Kulmasuojalista | Hörnskyddsprofil | Corner protection

TUOTENRO PRODUKTNR PRODUCT NO	VÄRI	FÄRG	COLOUR		PITUUS LÄNGD LENGTH	EAN-KOODI EAN-KOD EAN-CODE
L20 RST2	RST	Rostfritt stål	Stainless steel		2000	 6 4 17083 021152
L20 RST 3	RST	Rostfritt stål	Stainless steel		3000	 6 4 17083 027987

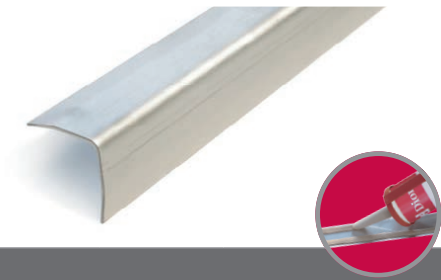
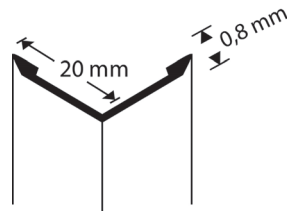

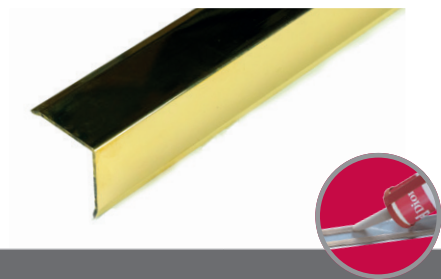
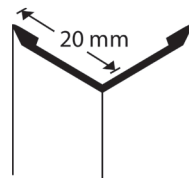

20 x 20 mm Kulmasuojalista | Hörnskyddsprofil | Corner protection

TUOTENRO PRODUKTNR PRODUCT NO	VÄRI	FÄRG	COLOUR		PITUUS LÄNGD LENGTH	EAN-KOODI EAN-KOD EAN-CODE
L2020 KSL3	RST	Rostfritt stål	Stainless steel		3000	 6 4 17083 028816



20 x 20 mm Kulmasuojalista | Hörnskyddsprofil | Corner protection

TUOTENRO PRODUKTNR PRODUCT NO	VÄRI	FÄRG	COLOUR		PITUUS LÄNGD LENGTH	EAN-KOODI EAN-KOD EAN-CODE
7333034	Messinki	Mässing	Brass		3000	 6 4 17083 028823

**KULMASUOJALISTAT**  
**HÖRNSKYDDSPROFILER**  
 CORNER PROTECTION

**metalliset**  
 av metall  
 metal

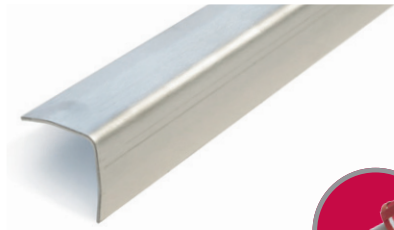
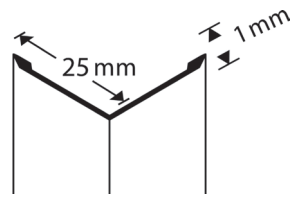

25 x 25 mm Kulmasuojalista | Hörnskyddsprofil | Corner protection

TUOTENRO PRODUKTNR PRODUCT NO	VÄRI	FÄRG	COLOUR		PITUUS LÄNGD LENGTH	EAN-KOODI EAN-KOD EAN-CODE
L25 RST2	RST	Rostfritt stål	Stainless steel		2000	 6 417083 021145

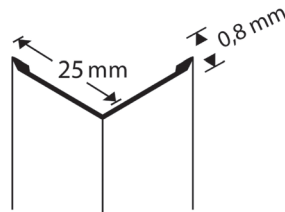

25 x 25 mm Kulmasuojalista | Hörnskyddsprofil | Corner protection

TUOTENRO PRODUKTNR PRODUCT NO	VÄRI	FÄRG	COLOUR		PITUUS LÄNGD LENGTH	EAN-KOODI EAN-KOD EAN-CODE
L2525 KSL3	RST	Rostfritt stål	Stainless steel		3000	 6 417083 028823



**B8 RST CU**  
 sivu/sidan/page  
 151

metalliset  
av metall  
metal

KULMASUOJALISTAT  
HÖRNSKYDDSPROFILER  
CORNER PROTECTION

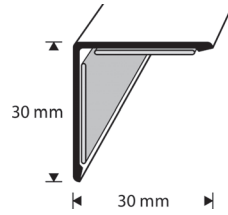

7303031-BL



30 x 30 mm Kulmasuojalista | Hörnskyddsprofil | Corner protection | ELASTICFIX

TUOTENRO PRODUKTNR PRODUCT NO	VÄRI	FÄRG	COLOUR		PITUUS LÄNGD LENGTH	EAN-KOODI EAN-KOD EAN-CODE
7303032	Hopea-anodisoitu	Silver anodiserad	Silver anodized		3000	
7303031-W	Maalattu valkoinen	Vitmålad	Painted white		3000	
7303031-BL	Maalattu musta	Svart målad	Painted black		3000	
B8 CBL3	Carbon black	Carbon black	Carbon black		3000	
B8 NG3	Nordic Graphite	Nordic Graphite	Nordic Graphite		3000	

**Nordic Graphite** -värisävy saattaa vaihdella valmistuksessa käytettävän harjaustekniikan vuoksi. Nyanssen **Nordic Graphite** kan variera beroende på den borstningsteknik som används vid tillverkningen. The **Nordic Graphite** shade may vary according to the brushing technique used in manufacturing.

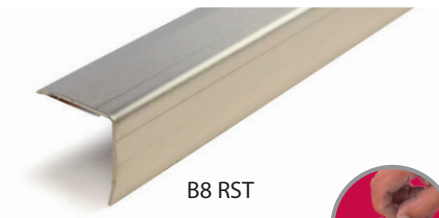
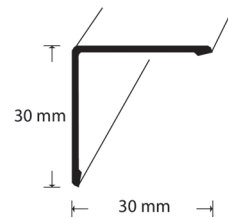

B8 RST



30 x 30 mm Kulmasuojalista | Hörnskyddsprofil | Corner protection | ELASTICFIX







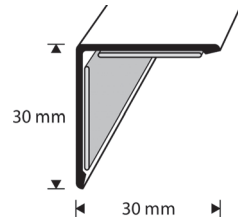





TUOTENRO PRODUKTNR PRODUCT NO	VÄRI	FÄRG	COLOUR		PITUUS LÄNGD LENGTH	EAN-KOODI EAN-KOD EAN-CODE
B8 RST 1	RST	Rostfritt stål	Stainless steel		1000	
B8 RST 150	RST	Rostfritt stål	Stainless steel		1500	
B8 RST 3	RST	Rostfritt stål	Stainless steel		3000	
B8 RST BL3	Bright black	Bright black	Bright black		3000	
B8 RST CU3	Bright copper	Bright copper	Bright copper		3000	
7301135	RST, kiiltohehkutettu	Rostfritt stål	Stainless steel, brilliant		3000	

**KULMASUOJALISTAT**  
**HÖRNSKYDDSPROFILER**  
 CORNER PROTECTION

**metalliset**  
 av metall  
 metal



30 x 30 mm Kulmasuojalista | Hörnskyddsprofil | Corner protection | ELASTICFIX  
 Puukuvioitu | Träimitation | Wood imitation

TUOTENRO PRODUKTNR PRODUCT NO	VÄRI	FÄRG	COLOUR		PITUUS LÄNGD LENGTH	EAN-KOODI EAN-KOD EAN-CODE
B8 CW 90	Cotton white	Cotton white	Cotton white		900	
B8 CW 180	Cotton white	Cotton white	Cotton white		1800	
B8 CW 270	Cotton white	Cotton white	Cotton white		2700	
B8 TA1	Tammi	Ek	Oak		1000	
B8 TA2	Tammi	Ek	Oak		2000	
B8 TA3	Tammi	Ek	Oak		3000	



**B8 TA**



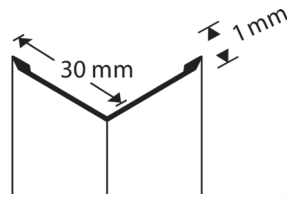

**B8 CW**

metalliset  
av metall  
metal

KULMASUOJALISTAT  
HÖRNSKYDDSPROFILER  
CORNER PROTECTION



30 x 30 mm Kulmasuojalista | Hörnskyddsprofil | Corner protection

TUOTENRO PRODUKTNR PRODUCT NO	VÄRI	FÄRG	COLOUR		PITUUS LÄNGD LENGTH	EAN-KOODI EAN-KOD EAN-CODE
L30 RST2	RST	Rostfritt stål	Stainless steel		2000	 6 4 17083 021138
L30 RST3	RST	Rostfritt stål	Stainless steel		3000	 6 4 17083 021336

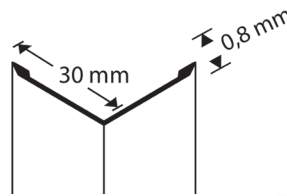

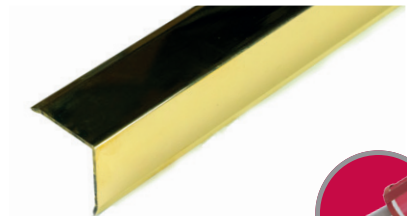
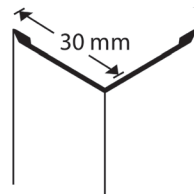

30 x 30 mm Kulmasuojalista | Hörnskyddsprofil | Corner protection

TUOTENRO PRODUKTNR PRODUCT NO	VÄRI	FÄRG	COLOUR		PITUUS LÄNGD LENGTH	EAN-KOODI EAN-KOD EAN-CODE
L3030 KSL3	RST	Rostfritt stål	Stainless steel		3000	 6 4 17083 028830



30 x 30 mm Kulmasuojalista | Hörnskyddsprofil | Corner protection

TUOTENRO PRODUKTNR PRODUCT NO	VÄRI	FÄRG	COLOUR		PITUUS LÄNGD LENGTH	EAN-KOODI EAN-KOD EAN-CODE
7303034	Messinki	Mässing	Brass		3000	 6 4 17083 035654

**KULMASUOJALISTAT**  
**HÖRNSKYDDSPROFILER**  
 CORNER PROTECTION

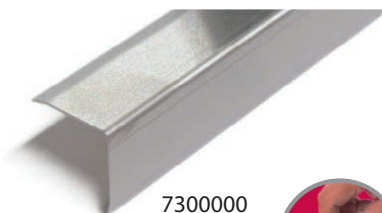
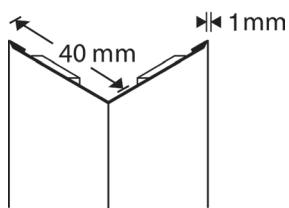

**metalliset**  
 av metall  
 metal



7300000



40 x 40 mm Kulmasuojalista | Hörnskyddsprofil | Corner protection | ELASTICFIX

TUOTENRO PRODUKTNR PRODUCT NO	VÄRI	FÄRG	COLOUR		PITUUS LÄNGD LENGTH	EAN-KOODI EAN-KOD EAN-CODE
7300000	RST	Rostfritt stål	Stainless steel		3000	 6 417083 949265
7300002	RST, kiiltohehkutettu	Rostfritt stål	Stainless steel, brilliant		3000	 6 417083 949173

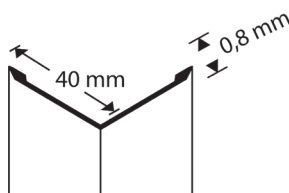

40 x 40 mm Kulmasuojalista | Hörnskyddsprofil | Corner protection

TUOTENRO PRODUKTNR PRODUCT NO	VÄRI	FÄRG	COLOUR		PITUUS LÄNGD LENGTH	EAN-KOODI EAN-KOD EAN-CODE
L4040 KSL3	RST	Rostfritt stål	Stainless steel		3000	 6 417083 028847

metalliset  
av metall  
metal

KULMASUOJALISTAT  
HÖRNSKYDDSPROFILER  
CORNER PROTECTION

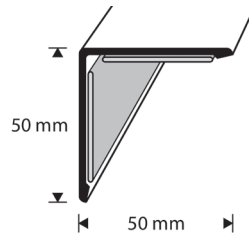

B9 NG



50 x 50 mm Kulmasuojalista | Hörnskyddsprofil | Corner protection | ELASTICFIX

TUOTENRO PRODUKTNR PRODUCT NO	VÄRI	FÄRG	COLOUR		PITUUS LÄNGD LENGTH	EAN-KOODI EAN-KOD EAN-CODE
B9 NG3	Nordic Graphite	Nordic Graphite	Nordic Graphite		3000	6 4 17083 031427
B9 RST 1	RST	Rostfritt stål	Stainless steel		1000	6 4 17083 027963
B9 RST 150	RST	Rostfritt stål	Stainless steel		1500	6 4 17083 022678
B9 RST 3	RST	Rostfritt stål	Stainless steel		3000	6 4 17083 027970
7311135	RST, kiiltohehkutettu	Rostfritt stål	Stainless steel, brilliant		3000	6 4 17083 111358

**Nordic Graphite** -värisävy saattaa vaihdella valmistuksessa käytettävän harjaustekniikan vuoksi.  
Nyansen **Nordic Graphite** kan variera beroende på den borstningsteknik som används vid tillverkningen.  
The **Nordic Graphite** shade may vary according to the brushing technique used in manufacturing.

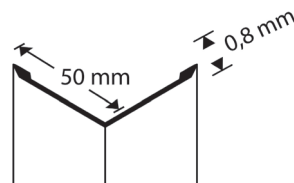

50 x 50 mm Kulmasuojalista | Hörnskyddsprofil | Corner protection



TUOTENRO PRODUKTNR PRODUCT NO	VÄRI	FÄRG	COLOUR		PITUUS LÄNGD LENGTH	EAN-KOODI EAN-KOD EAN-CODE
L5050 KSL2	RST	Rostfritt stål	Stainless steel		2000	6 4 17083 034039
L5050 KSL3	RST	Rostfritt stål	Stainless steel		3000	6 4 17083 028854

**KULMASUOJALISTAT**  
**HÖRNSKYDDSPROFILER**  
 CORNER PROTECTION

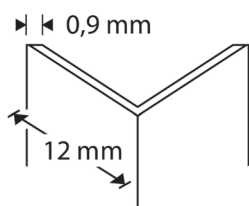
**muoviset**  
 av plast  
 plastic



12 x 12 mm Kulmasuojalista | Hörnskyddsprofil | Corner protection

TUOTENRO PRODUKTNR PRODUCT NO	VÄRI	FÄRG	COLOUR		PITUUS LÄNGD LENGTH	EAN-KOODI EAN-KOD EAN-CODE
NU 12-410	Valkoinen	Vit	White		2700	 6 417083 111129

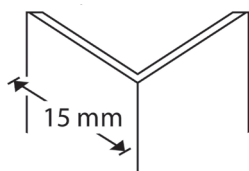

NU 15-470



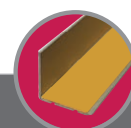
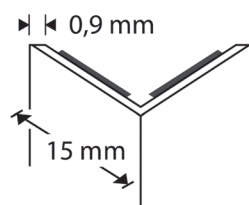

15 x 15 mm Kulmasuojalista | Hörnskyddsprofil | Corner protection

TUOTENRO PRODUKTNR PRODUCT NO	VÄRI	FÄRG	COLOUR		PITUUS LÄNGD LENGTH	EAN-KOODI EAN-KOD EAN-CODE
NU 15-410	Valkoinen	Vit	White		2700	 6 417083 111150
NU 15-412	Vaalean harmaa	Ljus grå	Light grey		2700	 6 417083 112157
NU 15-470	Musta	Svart	Black		2700	 6 417083 112317



15 x 15 mm Kulmasuojalista | Hörnskyddsprofil | Corner protection

TUOTENRO PRODUKTNR PRODUCT NO	VÄRI	FÄRG	COLOUR		PITUUS LÄNGD LENGTH	EAN-KOODI EAN-KOD EAN-CODE
NU 15T-410	Valkoinen	Vit	White		2700	 6 417083 020391

**muoviset**  
av plast  
plastic

**KULMASUOJALISTAT**  
**HÖRNSKYDDSPROFILER**  
CORNER PROTECTION

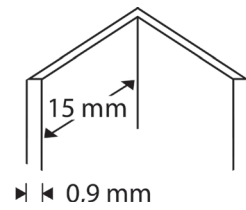

15 x 15 mm Sisäkulmasuojalista | Innerhörnlist | Inside corner trim

TUOTENRO PRODUKTNR PRODUCT NO	VÄRI	FÄRG	COLOUR		PITUUS LÄNGD LENGTH	EAN-KOODI EAN-KOD EAN-CODE
SN 15-410	Valkoinen	Vit	White		2700	 6 417083 111143

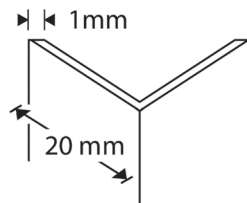

NU 20-410



20 x 20 mm Kulmasuojalista | Hörnskyddsprofil | Corner protection

TUOTENRO PRODUKTNR PRODUCT NO	VÄRI	FÄRG	COLOUR		PITUUS LÄNGD LENGTH	EAN-KOODI EAN-KOD EAN-CODE
NU 20-410	Valkoinen	Vit	White		2700	 6 417083 111204
NU 20-412	Vaalean harmaa	Ljus grå	Light grey		2700	 6 417083 112201
NU 20-470	Musta	Svart	Black		2700	 6 417083 041631

**KULMASUOJALISTAT**  
**HÖRNSKYDDSPROFILER**  
 CORNER PROTECTION

**muoviset**  
 av plast  
 plastic

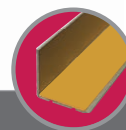
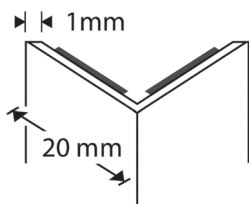

20 x 20 mm Kulmasuojalista | Hörnskyddsprofil | Corner protection

TUOTENRO PRODUKTNR PRODUCT NO	VÄRI	FÄRG	COLOUR		PITUUS LÄNGD LENGTH	EAN-KOODI EAN-KOD EAN-CODE
NU 20T-410	Valkoinen	Vit	White		2700	 6 417083 020407

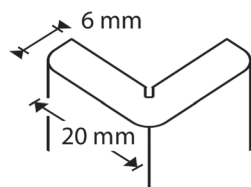

20 x 20 mm Kulmasuojalista | Hörnskyddsprofil | Corner protection

TUOTENRO PRODUKTNR PRODUCT NO	VÄRI	FÄRG	COLOUR		PITUUS LÄNGD LENGTH	EAN-KOODI EAN-KOD EAN-CODE
TC 20-410	Valkoinen	Vit	White		2700	 6 417083 136207

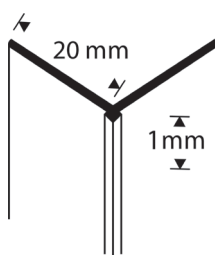

20 x 20 mm Tapettikulmalista | Tapetvinkellist | Corner trim for wallpaper

TUOTENRO PRODUKTNR PRODUCT NO	VÄRI	FÄRG	COLOUR		PITUUS LÄNGD LENGTH	EAN-KOODI EAN-KOD EAN-CODE
TK20	Valkoinen	Vit	White		2600	 6 417083 111020



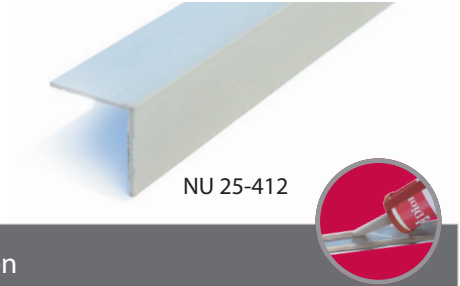
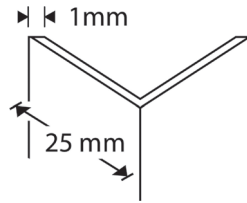

muoviset  
av plast  
plastic

KULMASUOJALISTAT  
HÖRNSKYDDSPROFILER  
CORNER PROTECTION



NU 25-412

25 x 25 mm Kulmasuojalista | Hörnskyddsprofil | Corner protection

TUOTENRO PRODUKTNR PRODUCT NO	VÄRI	FÄRG	COLOUR		PITUUS LÄNGD LENGTH	EAN-KOODI EAN-KOD EAN-CODE
NU 25-410	Valkoinen	Vit	White		2700	 6 417083 111259
NU 25-412	Vaalean harmaa	Ljus grå	Light grey		2700	 6 417083 111256
NU 25-470	Musta	Svart	Black		2700	 6 417083 112317

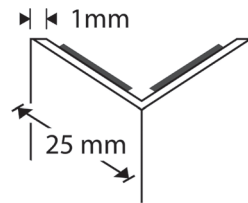



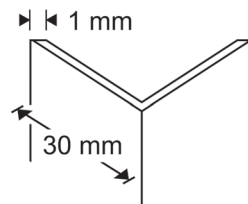

25 x 25 mm Kulmasuojalista | Hörnskyddsprofil | Corner protection

TUOTENRO PRODUKTNR PRODUCT NO	VÄRI	FÄRG	COLOUR		PITUUS LÄNGD LENGTH	EAN-KOODI EAN-KOD EAN-CODE
NU 25T-410	Valkoinen	Vit	White		2700	 6 417083 020445



30 x 30 mm Kulmasuojalista | Hörnskyddsprofil | Corner protection

TUOTENRO PRODUKTNR PRODUCT NO	VÄRI	FÄRG	COLOUR		PITUUS LÄNGD LENGTH	EAN-KOODI EAN-KOD EAN-CODE
NU 30-410	Valkoinen	Vit	White		2700	 6 417083 020926
NU 30-470	Musta	Svart	Black		2700	 6 417083 042645

**KULMASUOJALISTAT**  
**HÖRNSKYDDSPROFILER**  
 CORNER PROTECTION

**muoviset**  
 av plast  
 plastic

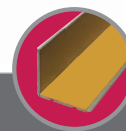
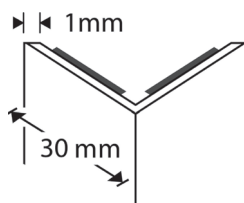

30 x 30 mm Kulmasuojalista | Hörnskyddsprofil | Corner protection

TUOTENRO PRODUKTNR PRODUCT NO	VÄRI	FÄRG	COLOUR		PITUUS LÄNGD LENGTH	EAN-KOODI EAN-KOD EAN-CODE
NU 30T-410	Valkoinen	Vit	White		2700	 6 417083 024788

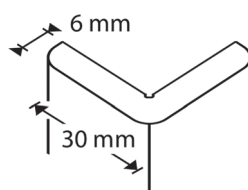

30 x 30 mm Kulmasuojalista | Hörnskyddsprofil | Corner protection

TUOTENRO PRODUKTNR PRODUCT NO	VÄRI	FÄRG	COLOUR		PITUUS LÄNGD LENGTH	EAN-KOODI EAN-KOD EAN-CODE
TC 30-410	Valkoinen	Vit	White		2700	 6 417083 126307

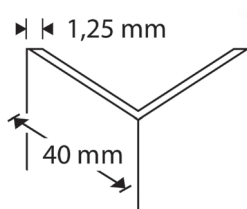

NU 40-412



40 x 40 mm Kulmasuojalista | Hörnskyddsprofil | Corner protection

TUOTENRO PRODUKTNR PRODUCT NO	VÄRI	FÄRG	COLOUR		PITUUS LÄNGD LENGTH	EAN-KOODI EAN-KOD EAN-CODE
NU 40-410	Valkoinen	Vit	White		2700	 6 417083 111402
NU 40-412	Vaalean harmaa	Ljus grå	Light grey		2700	 6 417083 112409
NU 40-470	Musta	Svart	Black		2700	 6 417083 042652

**muoviset**  
av plast  
plastic

**KULMASUOJALISTAT**  
**HÖRNSKYDDSPROFILER**  
CORNER PROTECTION

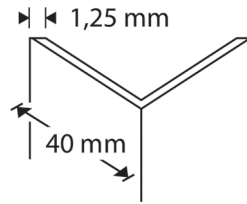

40 x 40 mm Kulmasuojalista | Hörnskyddsprofil | Corner protection

TUOTENRO PRODUKTNR PRODUCT NO	VÄRI	FÄRG	COLOUR		PITUUS LÄNGD LENGTH	EAN-KOODI EAN-KOD EAN-CODE
NU 40T-410	Valkoinen	Vit	White		2700	 6 4 17083 020469

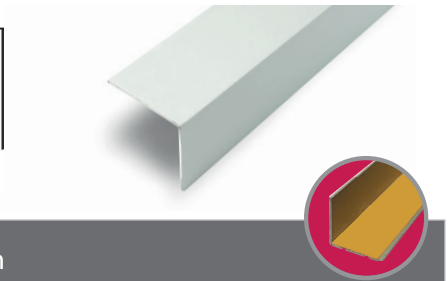
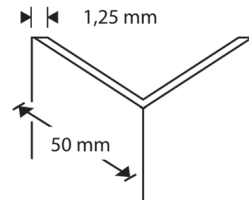

50 x 50 mm Kulmasuojalista | Hörnskyddsprofil | Corner protection

TUOTENRO PRODUKTNR PRODUCT NO	VÄRI	FÄRG	COLOUR		PITUUS LÄNGD LENGTH	EAN-KOODI EAN-KOD EAN-CODE
NU 50-410	Valkoinen	Vit	White		2700	 6 4 17083 035609

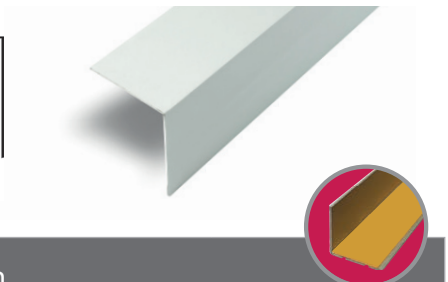
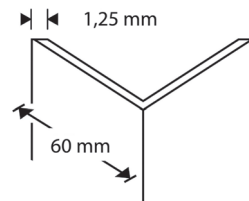

60 x 60 mm Kulmasuojalista | Hörnskyddsprofil | Corner protection

TUOTENRO PRODUKTNR PRODUCT NO	VÄRI	FÄRG	COLOUR		PITUUS LÄNGD LENGTH	EAN-KOODI EAN-KOD EAN-CODE
NU 60-410	Valkoinen	Vit	White		2700	 6 4 17083 035616

**KULMASUOJALISTAT**  
**HÖRNSKYDDSPROFILER**  
CORNER PROTECTION



**JLP 40-418**

sivu/sidan/page  
147

**NU 25-410**

sivu/sidan/page  
157

# LAATTALISTAT KAKELLISTER TILE TRIMS

## VIIMEISTELE KYLPYHUONEEN LAATOITUS LAATTALISTOILLA.

Metalliset laattalistat antavat kylpyhuonelaatoitukselle elegantin loppusilauksen ja suojaavat laatoitettuja kulmia. Samalle ne poistavat laattojen viistosahauksen tarpeen.

Muoviset Dione-laattalistat valmistetaan kovasta PVC-muovista. Kestävä materiaali soveltuu täydellisesti kylpyhuoneen kosteisiin olosuhteisiin ja päivittäiseen käyttöön. Muovilistat viimeistellään tyylikkäällä, kiillotetulla pinnoitteella, joka sointuu hyvin laattojen lasitukseen.

## SNYGG FINISH FÖR KAKLET MED KAKELLISTER.

Kakellister av metall ger badrumskaklet en elegant finish och skyddar även kakelplattornas kanter. Samtidigt innebär de även att kakelplattorna inte behöver geras.

Dione-kakellister av plast är gjorda av hård PVC. Det hållbara materialet lämpar sig utmärkt i den fuktiga miljön i badrummet och för dagligt bruk. Plastlisterna har en elegant polerad yta som passar väl med kaklets glaserings.

## COMPLETE YOUR BATHROOM TILING WITH TILE TRIMS.

Metal tile trims add an elegant finish to bathroom tiling while simultaneously protecting tiled edges. They also eliminate the need to mitre cut the tiles.

Dione plastic tile trims are made of hard PVC-plastic. This durable material is perfectly suited for the wet conditions and daily use of the bathroom. The trims have a polished surface finish, which matches the glazing of the tiles perfectly.





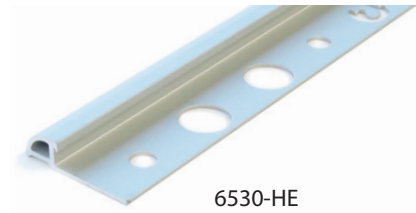
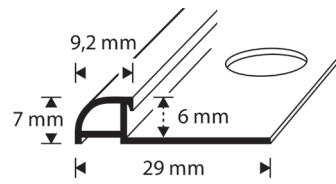

**LAATTALISTAT**  
**KAKELLISTER**  
 TILE TRIMS

**metalliset**  
 av metall  
 metal



6530-HE

H=6 mm Pyöreä | Rund | Circular

TUOTENRO PRODUKTNR PRODUCT NO	VÄRI	FÄRG	COLOUR		PITUUS LÄNGD LENGTH	EAN-KOODI EAN-KOD EAN-CODE
6530-HE	Hopea-anodisoitu	Silver anodiserad	Silver anodized		2700	 6 417 083 653056
6530-SILVER	Kromi-anodisoitu	Krom anodiserad	Chrome anodized		2700	 6 417 083 653018
6530-WHITE	Valkoinen	Vit	White		2700	 6 417 083 653049

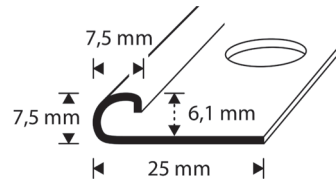

H=6 mm Pyöreä | Rund | Circular







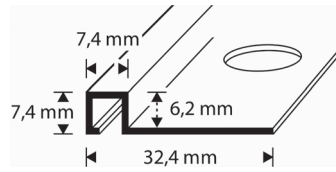

TUOTENRO PRODUKTNR PRODUCT NO	VÄRI	FÄRG	COLOUR		PITUUS LÄNGD LENGTH	EAN-KOODI EAN-KOD EAN-CODE
6530-RST	RST	Rostfritt stål	Stainless steel		2500	 6 417 083 653001

metalliset  
av metall  
metal

LAATTALISTAT  
KAKELLISTER  
TILE TRIMS



H=6 mm Neliö | Kvadrat | Square

TUOTENRO PRODUKTNR PRODUCT NO	VÄRI	FÄRG	COLOUR		PITUUS LÄNGD LENGTH	EAN-KOODI EAN-KOD EAN-CODE
6531-BLACK	Maalattu musta	Svart målad	Painted black		2500	 6 4 17083 653124
6531-HE	Hopea-anodisoitu	Silver anodiserad	Silver anodized		2700	 6 4 17083 653131
6531-NG	Nordic Graphite	Nordic Graphite	Nordic Graphite		2700	 6 4 17083 310126
6531-WHITE	Maalattu valkoinen	Vitmålad	Painted white		2700	 6 4 17083 653117

**Nordic Graphite** -värisävy saattaa vaihdella valmistuksessa käytettävän harjaustekniikan vuoksi.  
Nyansen **Nordic Graphite** kan variera beroende på den borstningsteknik som används vid tillverkningen.  
The **Nordic Graphite** shade may vary according to the brushing technique used in manufacturing.





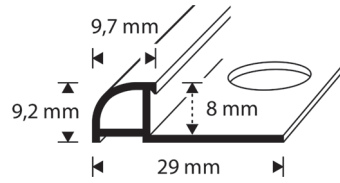

















LAATTALISTAT  
KAKELLISTER  
TILE TRIMS

metalliset  
av metall  
metal



6534-MUR

H=8 mm Pyöreä | Rund | Circular

TUOTENRO PRODUKTNR PRODUCT NO	VÄRI	FÄRG	COLOUR		PITUUS LÄNGD LENGTH	EAN-KOODI EAN-KOD EAN-CODE
6534-BLR	Black rustic	Black rustic	Black rustic		2700	 6 417 083 038 143
6534-CBL	Carbon black	Carbon black	Carbon black		2700	 6 417 083 024 863
6534-GRR	Grey rustic	Grey rustic	Grey rustic		2700	 6 417 083 038 112
6534-HE	Hopea-anodisoitu	Silver anodiserad	Silver anodized		2700	 6 417 083 653 421
6534-MUR	Mud rustic	Mud rustic	Mud rustic		2700	 6 417 083 038 136
6534-NG	Nordic Graphite	Nordic Graphite	Nordic Graphite		2700	 6 417 083 035 814
6534-SAR	Sand rustic	Sand rustic	Sand rustic		2700	 6 417 083 038 129
6534-SILVER	Kromi-anodisoitu	Krom anodiserad	Chrome anodized		2700	 6 417 083 653 490
6534-TITAN	Titan	Titan	Titan		2700	 6 417 083 024 856
6534-WHITE	Maalattu valkoinen	Vitmålad	Painted white		2700	 6 417 083 653 407
6534-WSR	White sand rustic	White sand rustic	White sand rustic		2700	 6 417 083 041 723







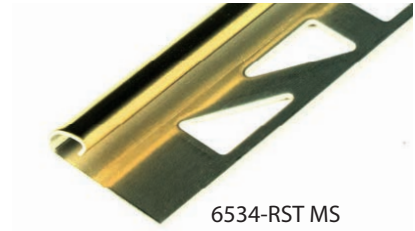
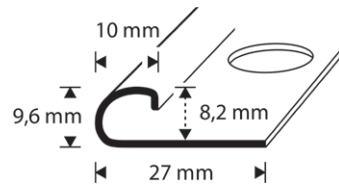



**Nordic Graphite** -värisävy saattaa vaihdella valmistuksessa käytettävän harjaustekniikan vuoksi.  
Nyansen **Nordic Graphite** kan variera beroende på den borstningsteknik som används vid tillverkningen.  
The **Nordic Graphite** shade may vary according to the brushing technique used in manufacturing.

metalliset  
av metall  
metal

LAATTALISTAT  
KAKELLISTER  
TILE TRIMS



H=8 mm Pyöreä | Rund | Circular

TUOTENRO PRODUKTNR PRODUCT NO	VÄRI	FÄRG	COLOUR		PITUUS LÄNGD LENGTH	EAN-KOODI EAN-KOD EAN-CODE
6534-RST	RST	Rostfritt stål	Stainless steel		2700	 6 4 17083 653414
6534-HST*	RST	Rostfritt stål	Stainless steel		2700	 6 4 17083 032158
6534-RST BL	Bright black	Bright black	Bright black		2700	 6 4 17083 038827
6534-RST CU	Bright copper	Bright copper	Bright copper		2700	 6 4 17083 038834
6534-RST MS	Bright brass	Bright brass	Bright brass		2700	 6 4 17083 038841

\*) **6534-HST** Haponkestävä RST AISI 316 | Syrafast rostfritt stål AISI 316 | Acid-resistant stainless steel AISI 316







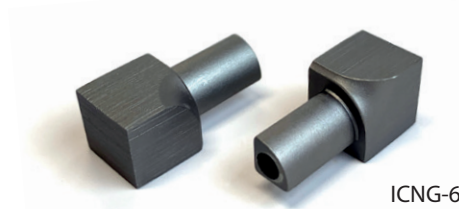











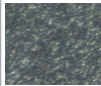







LAATTALISTAT  
KAKELLISTER  
TILE TRIMS

metalliset  
av metall  
metal

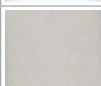

ICNG-6534

Sisäkulmapalat | Innerhörn bitar | Inner corner pieces H=8mm Pyöreä | Rund | Circular





















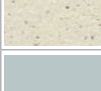

TUOTENRO PRODUKTNR PRODUCT NO	VÄRI	FÄRG	COLOUR		YHTEENSOPIVA KOMPATIBEL COMPATIBLE	EAN-KOODI EAN-KOD EAN-CODE
ICBL-6534	Maalattu musta	Svart målad	Painted black		6534-CBL 6534-BLR	 6 417 083 024 030
ICCBL-6534	Carbon black	Carbon black	Carbon black		6534-CBL 6534-BLR	 6 417 083 025 969
ICBS-6534	Kromi-anodisoitu	Krom anodiserad	Chrome anodized		6534-SILVER	 6 417 083 346 507
ICGRR-6534	Grey rustic	Grey rustic	Grey rustic		6534-GRR	 6 417 083 039 935
ICMUR-6534	Mud rustic	Mud rustic	Mud rustic		6534-MUR	 6 417 083 039 799
ICNG-6534	Nordic Graphite	Nordic Graphite	Nordic Graphite		6534-NG	 6 417 083 024 061
6534-IC	RST	Rostfritt stål	Stainless steel		6534-RST / HST	 6 417 083 656 088
ICSAR-6534	Sand rustic	Sand rustic	Sand rustic		6534-SAR	 6 417 083 039 911
ICS-6534	Hopea-anodisoitu	Silver anodiserad	Silver anodized		6534-HE	 6 417 083 653 476
ICT-6534	Titan	Titan	Titan		6534-TITAN	 6 417 083 025 976
ICW-6534	Maalattu valkoinen	Vitmålad	Painted white		6534-WHITE	 6 417 083 346 514
ICWSR-6534	White sand rustic	White sand rustic	White sand rustic		6534-WSR	 6 417 083 041 877

 **Nordic Graphite** -värisävy saattaa vaihdella valmistuksessa käytettävän harjaustekniikan vuoksi.  
Nyansen **Nordic Graphite** kan variera beroende på den borstningsteknik som används vid tillverkningen.  
The **Nordic Graphite** shade may vary according to the brushing technique used in manufacturing.

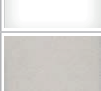

OCGRR-6534

Ulkokulmapalat | Ytterhörn bitar | Outer corner pieces H=8mm Pyöreä | Rund | Circular

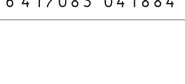
TUOTENRO PRODUKTNR PRODUCT NO	VÄRI	FÄRG	COLOUR		YHTEENSOPIVA KOMPATIBEL COMPATIBLE	EAN-KOODI EAN-KOD EAN-CODE
OCBL-6534	Maalattu musta	Svart målad	Painted black		6534-CBL 6534-BLR	 6 4 1 7 0 8 3 0 2 4 0 9 2
OCCBL-6534	Carbon black	Carbon black	Carbon black		6534-CBL 6534-BLR	 6 4 1 7 0 8 3 0 2 6 0 0 3
OCBS-6534	Kromi-anodisoitu	Krom anodiserad	Chrome anodized		6534-SILVER	 6 4 1 7 0 8 3 6 5 3 4 4 5
OCGRR-6534	Grey rustic	Grey rustic	Grey rustic		6534-GRR	 6 4 1 7 0 8 3 0 4 1 2 1 1
OCMUR-6534	Mud rustic	Mud rustic	Mud rustic		6534-MUR	 6 4 1 7 0 8 3 0 3 9 9 7 3
OCNG-6534	Nordic Graphite	Nordic Graphite	Nordic Graphite		6534-NG	 6 4 1 7 0 8 3 0 2 4 1 2 2
6534-OC	RST	Rostfritt stål	Stainless steel		6534-RST / HST	 6 4 1 7 0 8 3 6 5 6 0 9 5
OCSAR-6534	Sand rustic	Sand rustic	Sand rustic		6534-SAR	 6 4 1 7 0 8 3 0 3 9 9 9 7
OCS-6534	Hopea-anodisoitu	Silver anodiserad	Silver anodized		6534-HE	 6 4 1 7 0 8 3 6 5 3 4 5 2
OCT-6534	Titan	Titan	Titan		6534-TITAN	 6 4 1 7 0 8 3 6 5 6 0 6 4
OCW-6534	Maalattu valkoinen	Vitmålad	Painted white		6534-WHITE	 6 4 1 7 0 8 3 6 5 3 4 6 9
OCWSR-6534	White sand rustic	White sand rustic	White sand rustic		6534-WSR	 6 4 1 7 0 8 3 0 4 1 8 8 4

**Nordic Graphite** -värisävy saattaa vaihdella valmistuksessa käytettävän harjaustekniikan vuoksi.  
Nyansen **Nordic Graphite** kan variera beroende på den borstningsteknik som används vid tillverknigen.  
The **Nordic Graphite** shade may vary according to the brushing technique used in manufacturing.

LAATTALISTAT  
KAKELLISTER  
TILE TRIMS

metalliset  
av metall  
metal

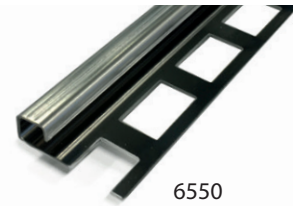
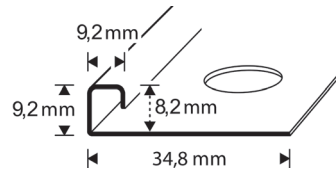

H=8 mm Neliö | Kvadrat | Square

TUOTENRO PRODUKTNR PRODUCT NO	VÄRI	FÄRG	COLOUR		PITUUS LÄNGD LENGTH	EAN-KOODI EAN-KOD EAN-CODE
6550	RST	Rostfritt stål	Stainless steel		2700	 6 417 083 6550 05
6550-HST*	RST	Rostfritt stål	Stainless steel		2700	 6 417 083 0236 75
6550-RST BL	Bright black	Bright black	Bright black		2700	 6 417 083 0384 19
6550-RST CU	Bright copper	Bright copper	Bright copper		2700	 6 417 083 0384 26
6550-RST MS	Bright brass	Bright brass	Bright brass		2700	 6 417 083 0384 33

\*) **6550-HST** Haponkestävä RST AISI 316 | Syrafast rostfritt stål AISI 316 | Acid-resistant stainless steel AISI 316



K-Rauta / Kuvaaja Thomas Broumand

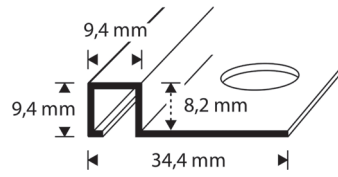

H=8 mm Neliö   Kvadrat   Square						
TUOTENRO PRODUKTNR PRODUCT NO	VÄRI	FÄRG	COLOUR		PITUUS LÄNGD LENGTH	EAN-KOODI EAN-KOD EAN-CODE
6541-BLACK	Maalattu musta	Svart målad	Painted black		2700	 6 417083 654121
6541-BLR	Black rustic	Black rustic	Black rustic		2700	 6 417083 038228
6541-CBL	Carbon black	Carbon black	Carbon black		2700	 6 417083 024849
6541-GRR	Grey rustic	Grey rustic	Grey rustic		2700	 6 417083 038198
6541-HE	Hopea-anodisoitu	Silver anodiserad	Silver anodized		2700	 6 417083 654138
6541-MUR	Mud rustic	Mud rustic	Mud rustic		2700	 6 417083 038211
6541-NG	Nordic Graphite	Nordic Graphite	Nordic Graphite		2700	 6 417083 310119
6541-SAR	Sand rustic	Sand rustic	Sand rustic		2700	 6 417083 038204
6541-SILVER	Kromi-anodisoitu	Krom anodiserad	Chrome anodized		2700	 6 417083 020153
6541-TITAN	Titan	Titan	Titan		2700	 6 417083 024832
6541-WHITE	Maalattu valkoinen	Vitmålad	Painted white		2700	 6 417083 654114
6541-WSR	White sand rustic	White sand rustic	White sand rustic		2700	 6 417083 041754

**Nordic Graphite** -värisävy saattaa vaihdella valmistuksessa käytettävän harjaustekniikan vuoksi. Nyansen **Nordic Graphite** kan variera beroende på den borstningsteknik som används vid tillverkningen. The **Nordic Graphite** shade may vary according to the brushing technique used in manufacturing.

LAATTALISTAT  
KAKELLISTER  
TILE TRIMS

metalliset  
av metall  
metal

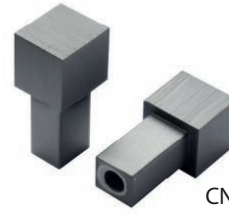

CNG-6541

Kulmapalat | Bitar | Corner pieces H=8mm Neliö | Kvadrat | Square

TUOTENRO PRODUKTNR PRODUCT NO	VÄRI	FÄRG	COLOUR		YHTEENSOPIVA KOMPATIBEL COMPATIBLE	EAN-KOODI EAN-KOD EAN-CODE
CBL-6541	Maalattu musta	Svart målad	Painted black		6541-BLACK	 6 417 083 023 897
CBS-6541	Kromi-anodisoitu	Krom anodiserad	Chrome anodized		6541-SILVER	 6 417 083 023 927
CHE-6541	Hopea-anodisoitu	Silver anodiserad	Silver anodized		6541-HE	 6 417 083 023 972
CNG-6541	Nordic Graphite	Nordic Graphite	Nordic Graphite		6541-NG	 6 417 083 023 941
CW-6541	Maalattu valkoinen	Vitmålad	Painted white		6541-WHITE	 6 417 083 023 996
6550-C	RST	Rostfritt stål	Stainless steel		6550 / 6550-HST	 6 417 083 628 672
CCBL-6541	Carbon black	Carbon black	Carbon black		6541-CBL 6541-BLR	 6 417 083 026 157
CT-6541	Titan	Titan	Titan		6541-TITAN	 6 417 083 026 164
CGRR-6541	Grey rustic	Grey rustic	Grey rustic		6541-GRR	 6 417 083 040 108
CMUR-6541	Mud rustic	Mud rustic	Mud rustic		6541-MUR	 6 417 083 040 061
CSAR-6541	Sand rustic	Sand rustic	Sand rustic		6541-SAR	 6 417 083 040 139
CWSR-6541	White sand rustic	White sand rustic	White sand rustic		6541-WSR	 6 417 083 041 938



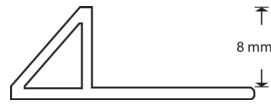

**Nordic Graphite** -värisävy saattaa vaihdella valmistuksessa käytettävän harjaustekniikan vuoksi.  
Nyansen **Nordic Graphite** kan variera beroende på den borstningsteknik som används vid tillverkningen.  
The **Nordic Graphite** shade may vary according to the brushing technique used in manufacturing.

metalliset  
av metall  
metal

LAATTALISTAT  
KAKELLISTER  
TILE TRIMS



H=8 mm 45 asteen kulma | 45 graders vinkel | 45 degree angle

TUOTENRO PRODUKTNR PRODUCT NO	VÄRI	FÄRG	COLOUR		PITUUS LÄNGD LENGTH	EAN-KOODI EAN-KOD EAN-CODE
ABS45 80	Kromi-anodisoitu	Krom anodiserad	Chrome anodized		2700	 6 4 17083 038600
ASI45 80	Hopea-anodisoitu	Silver anodiserad	Silver anodized		2700	 6 4 17083 038624



**6535**

sivu/sidan/page 174

Laattalistat  
Kakellister  
Tile trims





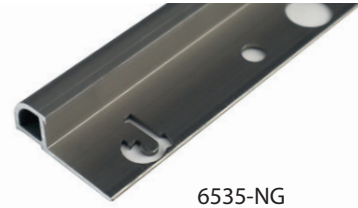
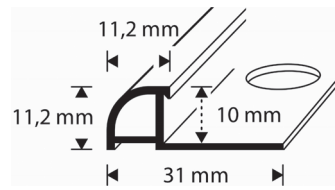





















LAATTALISTAT  
KAKELLISTER  
TILE TRIMS

metalliset  
av metall  
metal



6535-NG

H=10 mm Pyöreä | Rund | Circular

TUOTENRO PRODUKTNR PRODUCT NO	VÄRI	FÄRG	COLOUR		PITUUS LÄNGD LENGTH	EAN-KOODI EAN-KOD EAN-CODE
6535-BLACK	Maalattu musta	Svart målad	Painted black		2700	 6 417 083 653506
6535-BLR	Black rustic	Black rustic	Black rustic		2700	 6 417 083 038181
6535-CBL	Carbon black	Carbon black	Carbon black		2700	 6 417 083 023880
6535-GRR	Grey rustic	Grey rustic	Grey rustic		2700	 6 417 083 038150
6535-HE	Hopea-anodisoitu	Silver anodiserad	Silver anodized		2700	 6 417 083 653551
6535-MGR	Mouse grey	Mouse grey	Mouse grey		2500	 6 417 083 023866
6535-MUR	Mud rustic	Mud rustic	Mud rustic		2700	 6 417 083 038174
6535-NG	Nordic Graphite	Nordic Graphite	Nordic Graphite		2700	 6 417 083 256202
6535-SAR	Sand rustic	Sand rustic	Sand rustic		2700	 6 417 083 038167
6535-SILVER	Kromi-anodisoitu	Krom anodiserad	Chrome anodized		2700	 6 417 083 653513
6535-TITAN	Titan	Titan	Titan		2700	 6 417 083 023873
6535-WHITE	Maalattu valkoinen	Vitmålad	Painted white		2700	 6 417 083 653544
6535-WSR	White sand rustic	White sand rustic	White sand rustic		2700	 6 417 083 041730







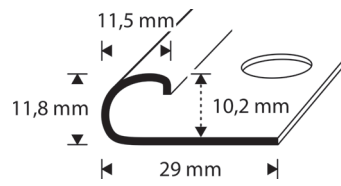







**Nordic Graphite** -värisävy saattaa vaihdella valmistuksessa käytettävän harjaustekniikan vuoksi.  
Nyanssen **Nordic Graphite** kan variera beroende på den borstningsteknik som används vid tillverkningen.  
The **Nordic Graphite** shade may vary according to the brushing technique used in manufacturing.

metalliset  
av metall  
metal

LAATTALISTAT  
KAKELLISTER  
TILE TRIMS



H=10 mm Pyöreä | Rund | Circular



















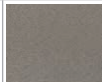



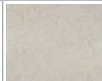

TUOTENRO PRODUKTNR PRODUCT NO	VÄRI	FÄRG	COLOUR		PITUUS LÄNGD LENGTH	EAN-KOODI EAN-KOD EAN-CODE
65353-RST	RST	Rostfritt stål	Stainless steel		3000	 6 4 17083 017322
6535-RST	RST	Rostfritt stål	Stainless steel		2700	 6 4 17083 653568
6535-RST HI	RST	Rostfritt stål	Stainless steel		2500	 6 4 17083 653575
6535-HST*	RST	Rostfritt stål	Stainless steel		2700	 6 4 17083 032165
6535-RST BL	Bright black	Bright black	Bright black		2700	 6 4 17083 038358
6535-RST CU	Bright copper	Bright copper	Bright copper		2700	 6 4 17083 038365
6535-RST MS	Bright brass	Bright brass	Bright brass		2700	 6 4 17083 038372

\*) **6535-HST** Haponkestävä RST AISI 316 | Syrafast rostfritt stål AISI 316 | Acid-resistant stainless steel AISI 316



ICSAR-6535

Sisäkulmapalat | Innerhörn bitar | Inner corner pieces H=10mm Pyöreä | Rund | Circular

TUOTENRO PRODUKTNR PRODUCT NO	VÄRI	FÄRG	COLOUR		YHTEENSOPIVA KOMPATIBEL COMPATIBLE	EAN-KOODI EAN-KOD EAN-CODE
ICBL-6535	Maalattu musta	Svart målad	Painted black		6535-BLACK	 6 417 083 024 047
ICCBL-6535	Carbon black	Carbon black	Carbon black		6535-CBL 6535-BLR	 6 417 083 356 049
ICBS-6535	Kromi-anodisoitu	Krom anodiserad	Chrome anodized		6535-SILVER	 6 417 083 653 698
ICGRR-6535	Grey rustic	Grey rustic	Grey rustic		6535-GRR	 6 417 083 039 942
ICMUR-6535	Mud rustic	Mud rustic	Mud rustic		6535-MUR	 6 417 083 039 805
ICNG-6535	Nordic graphite	Nordisk grafit	Nordic graphite		6535-NG	 6 417 083 024 078
ICSAR-6535	Sand rustic	Sand rustic	Sand rustic		6535-SAR	 6 417 083 039 928
ICS-6535	Hopea-anodisoitu	Silver anodiserad	Silver anodized		6535-HE	 6 417 083 653 629
ICT-6535	Titan	Titan	Titan		6535-TITAN	 6 417 083 356 056
ICW-6535	Maalattu valkoinen	Vitmålad	Painted white		6535-WHITE	 6 417 083 356 506
ICWSR-6535	White sand rustic	White sand rustic	White sand rustic		6535-WSR	 6 417 083 041 891
6535-IC	RST	Rostfritt stål	Stainless steel		6535-RST / HST	 6 417 083 653 599

 **Nordic Graphite** -värisävy saattaa vaihdella valmistuksessa käytettävän harjaustekniikan vuoksi.  
Nyanssen **Nordic Graphite** kan variera beroende på den borstningsteknik som används vid tillverkningen.  
The **Nordic Graphite** shade may vary according to the brushing technique used in manufacturing.



OCWSR-6535

Ulkokulmapalat   Ytterhörn bitar   Outer corner pieces H=10mm Pyöreä   Rund   Circular						
TUOTENRO PRODUKTNR PRODUCT NO	VÄRI	FÄRG	COLOUR		YHTEENSOPIVA KOMPATIBEL COMPATIBLE	EAN-KOODI EAN-KOD EAN-CODE
OCBL-6535	Maalattu musta	Svart målad	Painted black		6535-BLACK	 6 4 17083 024108
OCCBL-6535	Carbon Black	Carbon Black	Carbon Black		6535-CBL 6535-BLR	 6 4 17083 026034
OCBS-6535	Kromi-anodisoitu	Krom anodiserad	Chrome anodized		6535-SILVER	 6 4 17083 356575
OCGRR-6535	Grey rustic	Grey rustic	Grey rustic		6535-GRR	 6 4 17083 040030
OCMUR-6535	Mud rustic	Mud rustic	Mud rustic		6535-MUR	 6 4 17083 039980
OCNG-6535	Nordic Graphite	Nordic Graphite	Nordic Graphite		6535-NG	 6 4 17083 024139
OCSAR-6535	Sand rustic	Sand rustic	Sand rustic		6535-SAR	 6 4 17083 040016
OCS-6535	Hopea-anodisoitu	Silver anodiserad	Silver anodized		6535-HE	 6 4 17083 653674
OCT-6535	Titan	Titan	Titan		6535-TITAN	 6 4 17083 656071
OCW-6535	Maalattu valkoinen	Vitmålad	Painted white		6535-WHITE	 6 4 17083 653681
OCWSR-6535	White sand rustic	White sand rustic	White sand rustic		6535-WSR	 6 4 17083 041907
6535-OC	RST	Rostfritt stål	Stainless steel		6535-RST/HST	 6 4 17083 653582

 **Nordic Graphite** -värisävy saattaa vaihdella valmistuksessa käytettävän harjaustekniikan vuoksi. Nyanssen **Nordic Graphite** kan variera beroende på den borstningsteknik som används vid tillverkningen. The **Nordic Graphite** shade may vary according to the brushing technique used in manufacturing.





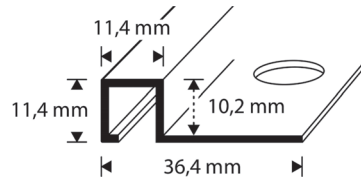





















LAATTALISTAT  
KAKELLISTER  
TILE TRIMS

metalliset  
av metall  
metal



6551-HE

H=10 mm Neliö | Kvadrat | Square

TUOTENRO PRODUKTNR PRODUCT NO	VÄRI	FÄRG	COLOUR		PITUUS LÄNGD LENGTH	EAN-KOODI EAN-KOD EAN-CODE
6551-BLACK	Maalattu musta	Svart målad	Painted black		2700	 6 417 083 655128
6551-BLR	Black rustic	Black rustic	Black rustic		2700	 6 417 083 038266
6551-CBL	Carbon black	Carbon black	Carbon black		2700	 6 417 083 023859
6551-GRR	Grey rustic	Grey rustic	Grey rustic		2700	 6 417 083 038235
6551-HE	Hopea-anodisoitu	Silver anodiserad	Silver anodized		2700	 6 417 083 655135
6551-MGR	Mouse grey	Mouse grey	Mouse grey		2700	 6 417 083 023835
6551-MUR	Mud rustic	Mud rustic	Mud rustic		2700	 6 417 083 038259
6551-NG	Nordic graphite	Nordisk grafit	Nordic graphite		2700	 6 417 083 310133
6551-SAR	Sand rustic	Sand rustic	Sand rustic		2700	 6 417 083 038242
6551-SILVER	Kromi-anodisoitu	Krom anodiserad	Chrome anodized		2700	 6 417 083 018701
6551-TITAN	Titan	Titan	Titan		2700	 6 417 083 023842
6551-WHITE	Maalattu valkoinen	Vitmålad	Painted white		2700	 6 417 083 655111
6551-WSR	White sand rustic	White sand rustic	White sand rustic		2700	 6 417 083 041761







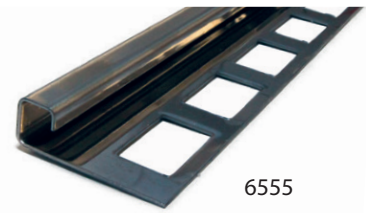
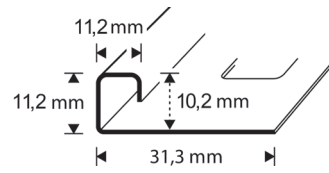





**Nordic Graphite** -värisävy saattaa vaihdella valmistuksessa käytettävän harjaustekniikan vuoksi.  
Nyanssen **Nordic Graphite** kan variera beroende på den borstningsteknik som används vid tillverkningen.  
The **Nordic Graphite** shade may vary according to the brushing technique used in manufacturing.

metalliset  
av metall  
metal

LAATTALISTAT  
KAKELLISTER  
TILE TRIMS



H=10 mm Neliö | Kvadrat | Square

TUOTENRO PRODUKTNR PRODUCT NO	VÄRI	FÄRG	COLOUR		PITUUS LÄNGD LENGTH	EAN-KOODI EAN-KOD EAN-CODE
6553	RST	Rostfritt stål	Stainless steel		3000	 6 417083 010972
6555	RST	Rostfritt stål	Stainless steel		2700	 6 417083 655500
6555-HST*	RST	Rostfritt stål	Stainless steel		2700	 6 417083 023682
6555-RST BL	Bright black	Bright black	Bright black		2700	 6 417083 038471
6555-RST CU	Bright copper	Bright copper	Bright copper		2700	 6 417083 038488
6555-RST MS	Bright brass	Bright brass	Bright brass		2700	 6 417083 038495

\*) **6555-HST** Haponkestävä RST AISI 316 | Syrafast rostfritt stål AISI 316 | Acid-resistant stainless steel AISI 316

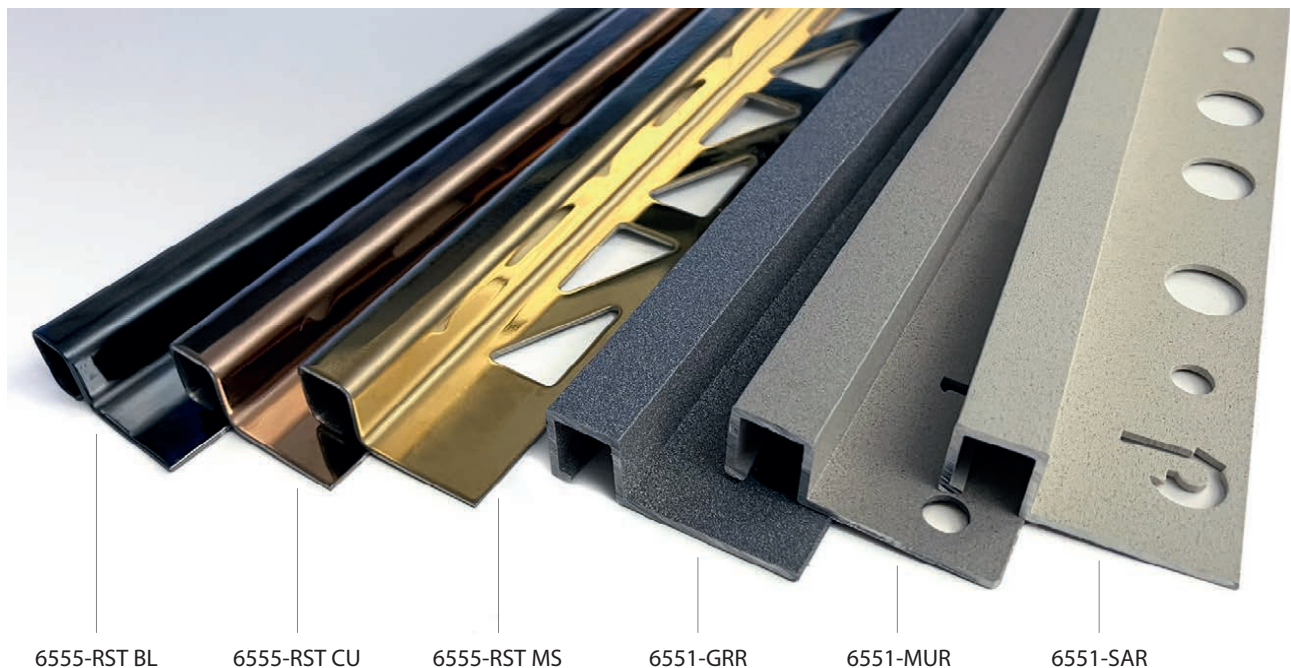

6555-RST BL

6555-RST CU

6555-RST MS

6551-GRR

















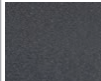





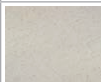

6551-MUR

6551-SAR



CGRR-6551

Kulmapalat | Bitar | Corner pieces H=10mm Neliö | Kvadrat | Square

TUOTENRO PRODUKTNR PRODUCT NO	VÄRI	FÄRG	COLOUR		YHTEENSOPIVA KOMPATIBEL COMPATIBLE	EAN-KOODI EAN-KOD EAN-CODE
CBL-6551	Maalattu musta	Svart målad	Painted black		6551-BLACK	 6 417 083 023 903
CBS-6551	Kromi-anodisoitu	Krom anodiserad	Chrome anodized		6551-SILVER	 6 417 083 027 703
CCBL-6551	Carbon black	Carbon black	Carbon black		6551-CBL 6551-BLR	 6 417 083 026 195
CGRR-6551	Grey rustic	Grey rustic	Grey rustic		6551-GRR	 6 417 083 040 115
CHE-6551	Hopea-anodisoitu	Silver anodiserad	Silver anodized		6551-HE	 6 417 083 020 209
CMUR-6551	Mud rustic	Mud rustic	Mud rustic		6551-MUR	 6 417 083 040 146
CNG-6551	Nordic graphite	Nordisk grafit	Nordic graphite		6551-NG	 6 417 083 023 958
CSAR-6551	Sand rustic	Sand rustic	Sand rustic		6551-SAR	 6 417 083 040 092
CT-6551	Titan	Titan	Titan		6551-TITAN	 6 417 083 026 188
CW-6551	Maalattu valkoinen	Vitmålad	Painted white		6551-WHITE	 6 417 083 024 016
CWSR-6551	White sand rustic	White sand rustic	White sand rustic		6551-WSR	 6 417 083 041 945
6555-C	RST	Rostfritt stål	Stainless steel		6555 / 6555-HST	 6 417 083 628 658

 **Nordic Graphite** -värisävy saattaa vaihdella valmistuksessa käytettävän harjaustekniikan vuoksi.  
Nyansen **Nordic Graphite** kan variera beroende på den borstningsteknik som används vid tillverkningen.  
The **Nordic Graphite** shade may vary according to the brushing technique used in manufacturing.

metalliset  
av metall  
metal

LAATTALISTAT  
KAKELLISTER  
TILE TRIMS

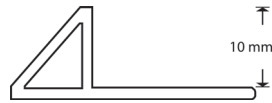

ABS45 100

H=10 mm 45 asteen kulma | 45 graders vinkel | 45 degree angle

TUOTENRO PRODUKTNR PRODUCT NO	VÄRI	FÄRG	COLOUR		PITUUS LÄNGD LENGTH	EAN-KOODI EAN-KOD EAN-CODE
ABS45 100	Kromi-anodisoitu	Krom anodiserad	Chrome anodized		2700	 6 417083 038594
ASI45 100	Hopea-anodisoitu	Silver anodiserad	Silver anodized		2700	 6 417083 038617



ABS45 100

ASI45 100





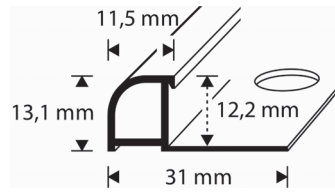

















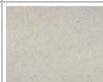

LAATTALISTAT  
KAKELLISTER  
TILE TRIMS

metalliset  
av metall  
metal

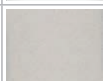

6570-WHITE

H=12 mm Pyöreä | Rund | Circular

TUOTENRO PRODUKTNR PRODUCT NO	VÄRI	FÄRG	COLOUR		PITUUS LÄNGD LENGTH	EAN-KOODI EAN-KOD EAN-CODE
6570-BLACK	Maalattu musta	Svart målad	Painted black		2700	 6 417083 657009
6570-BLR	Black rustic	Black rustic	Black rustic		2700	 6 417083 041280
6570-CBL	Carbon black	Carbon black	Carbon black		2700	 6 417083 026485
6570-GRR	Grey rustic	Grey rustic	Grey rustic		2700	 6 417083 041297
6570-HE	Hopea-anodisoitu	Silver anodiserad	Silver anodized		2700	 6 417083 657054
6570-MUR	Mud rustic	Mud rustic	Mud rustic		2700	 6 417083 041303
6570-NG	Nordic graphite	Nordisk grafit	Nordic graphite		2700	 6 417083 657061
6570-SAR	Sand rustic	Sand rustic	Sand rustic		2700	 6 417083 041310
6570-SILVER	Kromi-anodisoitu	Krom anodiserad	Chrome anodized		2700	 6 417083 657016
6570-TITAN	Titan	Titan	Titan		2700	 6 417083 024894
6570-WHITE	Maalattu valkoinen	Vitmålad	Painted white		2700	 6 417083 657047
6570-WSR	White sand rustic	White sand rustic	White sand rustic		2700	 6 417083 041747

 **Nordic Graphite** -värisävy saattaa vaihdella valmistuksessa käytettävän harjaustekniikan vuoksi.  
Nyansen **Nordic Graphite** kan variera beroende på den borstningsteknik som används vid tillverkningen.  
The **Nordic Graphite** shade may vary according to the brushing technique used in manufacturing.



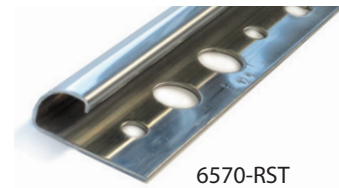
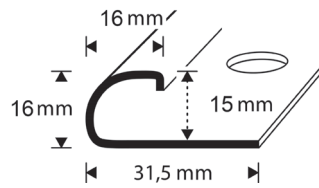

metalliset  
av metall  
metal

LAATTALISTAT  
KAKELLISTER  
TILE TRIMS



6570-RST

H=12 mm Pyöreä | Rund | Circular

TUOTENRO PRODUKTNR PRODUCT NO	VÄRI	FÄRG	COLOUR		PITUUS LÄNGD LENGTH	EAN-KOODI EAN-KOD EAN-CODE
6570-RST	RST	Rostfritt stål	Stainless steel		2700	 6 4 17083 657092
6570-HST*	RST	Rostfritt stål	Stainless steel		2700	 6 4 17083 032172

\*) **6570-HST** Haponkestävä RST AISI 316 | Syrafast rostfritt stål AISI 316 | Acid-resistant stainless steel AISI 316

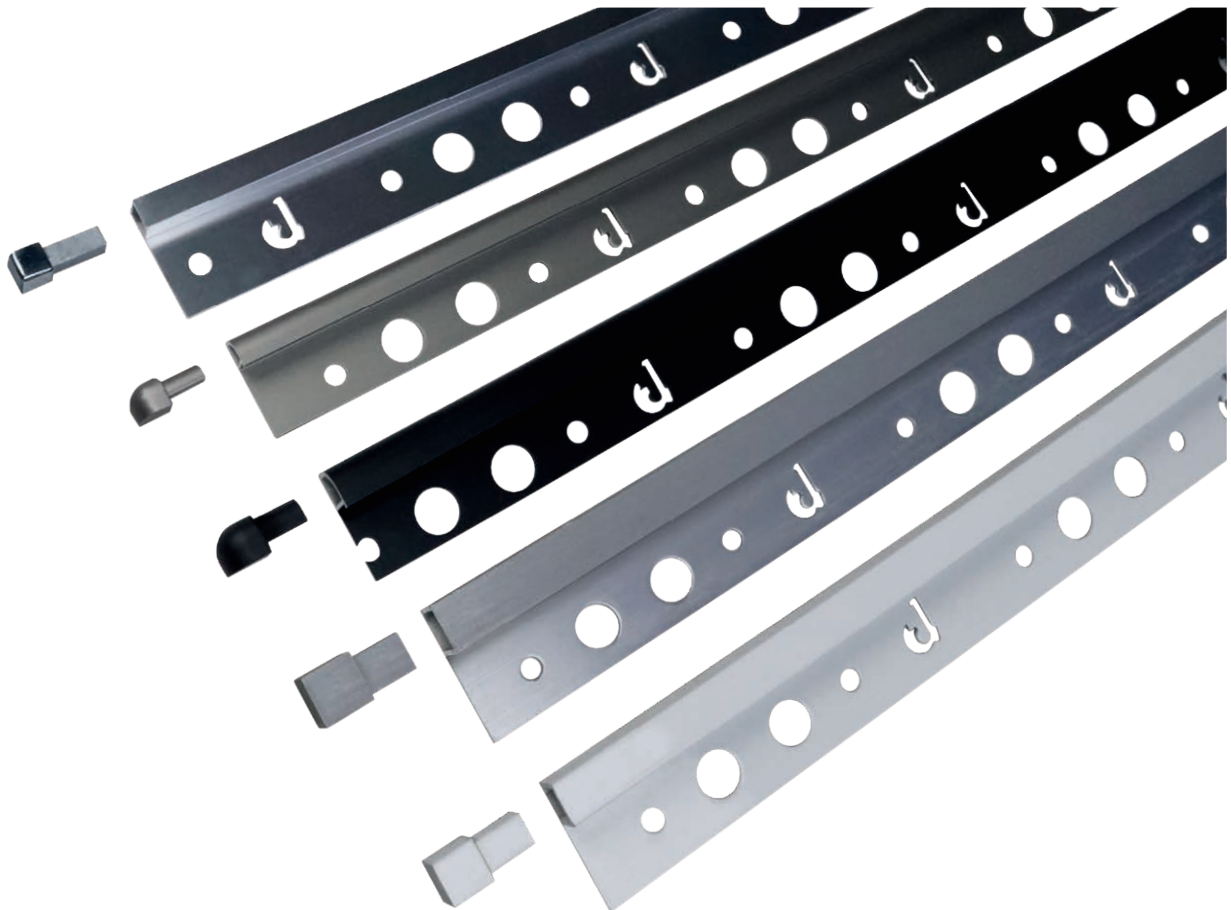



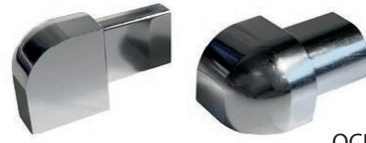

LAATTALISTAT  
KAKELLISTER  
TILE TRIMS

metalliset  
av metall  
metal



OCBS-6570

Sisäkulmapalat | Innerhörn bitar | Inner corner pieces H=12mm Pyöreä | Rund | Circular

TUOTENRO PRODUKTNR PRODUCT NO	VÄRI	FÄRG	COLOUR		YHTEENSOPIVA KOMPATIBEL COMPATIBLE	EAN-KOODI EAN-KOD EAN-CODE
ICBL-6570	Maalattu musta	Svart målad	Painted black		6570-BLACK	 6 417 083 024 054
ICBS-6570	Kromi-anodisoitu	Krom anodiserad	Chrome anodized		6570-SILVER	 6 417 083 653 605
ICCBL-6570	Carbon black	Carbon black	Carbon black		6570-CBL 6570-BLR	 6 417 083 025 983
ICGRR-6570	Grey rustic	Grey rustic	Grey rustic		6570-GRR	 6 417 083 041 457
ICMUR-6570	Mud rustic	Mud rustic	Mud rustic		6570-MUR	 6 417 083 041 464
ICNG-6570	Nordic graphite	Nordisk grafit	Nordic graphite		6570-NG	 6 417 083 024 085
ICS-6570	Hopea-anodisoitu	Silver anodiserad	Silver anodized		6570-HE	 6 417 083 653 612
ICSAR-6570	Sand rustic	Sand rustic	Sand rustic		6570-SAR	 6 417 083 041 471
ICT-6570	Titan	Titan	Titan		6570-TITAN	 6 417 083 025 990
ICW-6570	Maalattu valkoinen	Vitmålad	Painted white		6570-WHITE	 6 417 083 653 636
ICWSR-6570	White sand rustic	White sand rustic	White sand rustic		6570-WSR	 6 417 083 041 914
6570-IC	RST	Rostfritt stål	Stainless steel		6570-RST / HST	 6 417 083 656 101

 **Nordic Graphite** -värisävy saattaa vaihdella valmistuksessa käytettävän harjaustekniikan vuoksi.  
Nyansen **Nordic Graphite** kan variera beroende på den borstningsteknik som används vid tillverkningen.  
The **Nordic Graphite** shade may vary according to the brushing technique used in manufacturing.

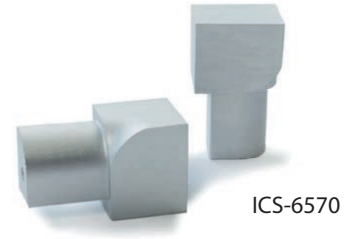

Ulkokulmapalat   Ytterhörn bitar   Outer corner pieces H=12mm Pyöreä   Rund   Circular						
TUOTENRO PRODUKTNR PRODUCT NO	VÄRI	FÄRG	COLOUR		YHTEENSOPIVA KOMPATIBEL COMPATIBLE	EAN-KOODI EAN-KOD EAN-CODE
OCBL-6570	Maalattu musta	Svart målad	Painted black		6570-BLACK	 6 4 17083 024115
OCBS-6570	Kromi-anodisoitu	Krom anodiserad	Chrome anodized		6570-SILVER	 6 4 17083 653643
OCCBL-6570	Carbon black	Carbon black	Carbon black		6570-CBL 6570-BLR	 6 4 17083 026010
OCGRR-6570	Grey rustic	Grey rustic	Grey rustic		6570-GRR	 6 4 17083 041488
OCMUR-6570	Mud rustic	Mud rustic	Mud rustic		6570-MUR	 6 4 17083 041495
OCNG-6570	Nordic graphite	Nordisk grafit	Nordic graphite		6570-NG	 6 4 17083 024146
OCS-6570	Hopea-anodisoitu	Silver anodiserad	Silver anodized		6570-HE	 6 4 17083 653650
OCSAR-6570	Sand rustic	Sand rustic	Sand rustic		6570-SAR	 6 4 17083 041501
OCT-6570	Titan	Titan	Titan		6570-TITAN	 6 4 17083 026027
OCW-6570	Maalattu valkoinen	Vitmålad	Painted white		6570-WHITE	 6 4 17083 653667
OCWSR-6570	Sand rustic	Sand rustic	Sand rustic		6570-WSR	 6 4 17083 041921
6570-OC	RST	Rostfritt stål	Stainless steel		6570-RST / HST	 6 4 17083 628663

**Nordic Graphite** -värisävy saattaa vaihdella valmistuksessa käytettävän harjaustekniikan vuoksi. Nyansen **Nordic Graphite** kan variera beroende på den borstningsteknik som används vid tillverkningen. The **Nordic Graphite** shade may vary according to the brushing technique used in manufacturing.

LAATTALISTAT  
KAKELLISTER  
TILE TRIMS

metalliset  
av metall  
metal

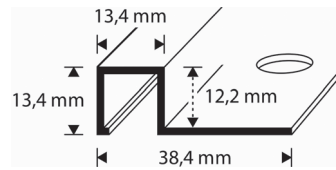



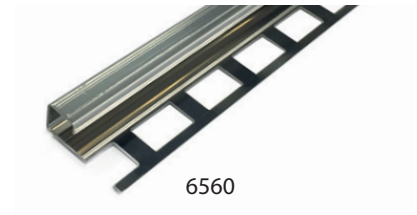
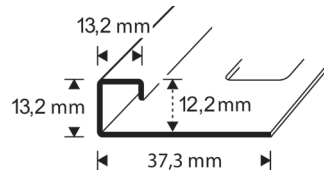

H=12 mm Neliö | Kvadrat | Square

TUOTENRO PRODUKTNR PRODUCT NO	VÄRI	FÄRG	COLOUR		PITUUS LÄNGD LENGTH	EAN-KOODI EAN-KOD EAN-CODE
6561-BLACK	Maalattu musta	Svart målad	Painted black		2700	 6 417 083 656125
6561-BLR	Black rustic	Black rustic	Black rustic		2700	 6 417 083 041327
6561-CBL	Carbon black	Carbon black	Carbon black		2700	 6 417 083 024887
6561-GRR	Grey rustic	Grey rustic	Grey rustic		2700	 6 417 083 041334
6561-HE	Hopea-anodisoitu	Silver anodiserad	Silver anodized		2700	 6 417 083 656149
6561-MUR	Mud rustic	Mud rustic	Mud rustic		2700	 6 417 083 041341
6561-NG	Nordic graphite	Nordisk grafit	Nordic graphite		2700	 6 417 083 310140
6561-SAR	Sand rustic	Sand rustic	Sand rustic		2700	 6 417 083 041358
6561-SILVER	Kromi-anodisoitu	Krom anodiserad	Chrome anodized		2700	 6 417 083 020162
6561-TITAN	Titan	Titan	Titan		2700	 6 417 083 024870
6561-WHITE	Maalattu valkoinen	Vitmålad	Painted white		2700	 6 417 083 656118
6561-WSR	White sand rustic	White sand rustic	White sand rustic		2700	 6 417 083 041778

**Nordic Graphite** -värisävy saattaa vaihdella valmistuksessa käytettävän harjaustekniikan vuoksi.  
Nyansen **Nordic Graphite** kan variera beroende på den borstningsteknik som används vid tillverknigen.  
The **Nordic Graphite** shade may vary according to the brushing technique used in manufacturing.



H=12 mm Neliö   Kvadrat   Square						
TUOTENRO PRODUKTNR PRODUCT NO	VÄRI	FÄRG	COLOUR		PITUUS LÄNGD LENGTH	EAN-KOODI EAN-KOD EAN-CODE
6560	RST	Rostfritt stål	Stainless steel		2700	 6 4 17083 065606
6560-HST*	RST	Rostfritt stål	Stainless steel		2700	 6 4 17083 024160

\*) **6560-HST** Haponkestävä RST AISI 316 | Syräfast rostfritt stål AISI 316 | Acid-resistant stainless steel AISI 316



Kulmapalat   Bitar   Corner pieces H=12mm Neliö   Kvadrat   Square						
TUOTENRO PRODUKTNR PRODUCT NO	VÄRI	FÄRG	COLOUR		YHTEENSOPIVA KOMPATIBEL COMPATIBLE	EAN-KOODI EAN-KOD EAN-CODE
CBL-6561	Maalattu musta	Svart målad	Painted black		6561-BLACK	 6 4 17083 023910
CBS-6561	Kromi-anodisoitu	Krom anodiserad	Chrome anodized		6561-SILVER	 6 4 17083 023934
CCBL-6561	Carbon black	Carbon black	Carbon black		6561-CBL 6561-BLR	 6 4 17083 026201
CGRR-6561	Grey rustic	Grey rustic	Grey rustic		6561-GRR	 6 4 17083 041518
CHE-6561	Hopea-anodisoitu	Silver anodiserad	Silver anodized		6561-HE	 6 4 17083 023989
CMUR-6561	Mud rustic	Mud rustic	Mud rustic		6561-MUR	 6 4 17083 041525
CNG-6561	Nordic graphite	Nordisk grafit	Nordic graphite		6561-NG	 6 4 17083 023965

JATKUU SEURAAVALLA SIVULLA  
FORTSÄTTER PÅ NÄSTA SIDA  
CONTINUED ON THE NEXT PAGE



LAATTALISTAT  
KAKELLISTER  
TILE TRIMS

metalliset  
av metall  
metal



CT-6561



JATKOA EDELLISELTÄ SIVULTA  
FORTSÄTTER FRÅN FÖREGÅENDE SIDA  
CONTINUED FROM THE PREVIOUS PAGE

Kulmapalat | Bitar | Corner pieces H=12mm Neliö | Kvadrat | Square

TUOTENRO PRODUKTNR PRODUCT NO	VÄRI	FÄRG	COLOUR		YHTEENSOPIVA KOMPATIBEL COMPATIBLE	EAN-KOODI EAN-KOD EAN-CODE
CSAR-6561	Sand rustic	Sand rustic	Sand rustic		6561-SAR	 6 417 083 041532
CT-6561	Titan	Titan	Titan		6561-TITAN	 6 417 083 026171
CW-6561	Maalattu valkoinen	Vitmålad	Painted white		6561-WHITE	 6 417 083 024023
CWSR-6561	White sand rustic	White sand rustic	White sand rustic		6561-WSR	 6 417 083 041532
6560-C	RST	Rostfritt stål	Stainless steel		6560 / 6560-HST	 6 417 083 628689

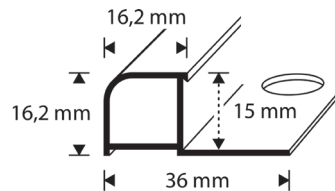

6575-NG

H=15 mm Pyöreä | Rund | Circular

TUOTENRO PRODUKTNR PRODUCT NO	VÄRI	FÄRG	COLOUR		PITUUS LÄNGD LENGTH	EAN-KOODI EAN-KOD EAN-CODE
6575-NG	Nordic graphite	Nordisk grafit	Nordic graphite		2500	 6 417 083 190445

**Nordic Graphite** -värisävy saattaa vaihdella valmistuksessa käytettävän harjaustekniikan vuoksi.  
Nyanssen **Nordic Graphite** kan variera beroende på den borstringsteknik som används vid tillverknigen.  
The **Nordic Graphite** shade may vary according to the brushing technique used in manufacturing.

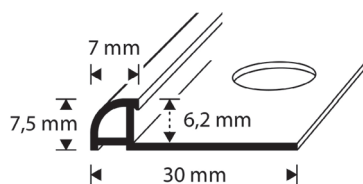

H=6 mm Pyöreä | Rund | Circular

TUOTENRO PRODUKTNR PRODUCT NO	VÄRI	FÄRG	COLOUR		PITUUS LÄNGD LENGTH	EAN-KOODI EAN-KOD EAN-CODE
6510-BEIGE	Beige	Beige	Beige		2500	 6 4 17083 651045
6510-BROKEN WHITE	Maalarinvalkoinen	Bruten vit	Broken white		2500	 6 4 17083 651007
6510-GREY	Keskiharmaa	Grå	Grey		2700	 6 4 17083 651052
6510-LIGHT GREY	Vaalean harmaa	Ljus grå	Light Grey		2700	 6 4 17083 651014
6510-WHITE	Valkoinen	Vit	White		2700	 6 4 17083 561092

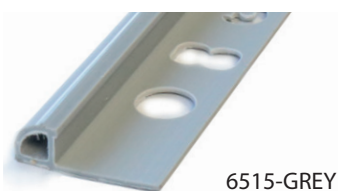
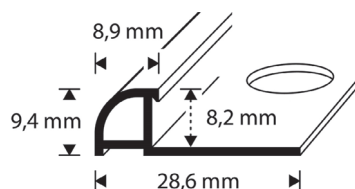

H=8 mm Pyöreä | Rund | Circular

TUOTENRO PRODUKTNR PRODUCT NO	VÄRI	FÄRG	COLOUR		PITUUS LÄNGD LENGTH	EAN-KOODI EAN-KOD EAN-CODE
6515-BEIGE	Beige	Beige	Beige		2500	 6 4 17083 651540
6515-BLACK	Musta	Svart	Black		2700	 6 4 17083 038273
6515-BROKEN WHITE	Maalarinvalkoinen	Bruten vit	Broken white		2700	 6 4 17083 651502
6515-GREY	Keskiharmaa	Grå	Grey		2700	 6 4 17083 651557
6515-LIGHT GREY	Vaalean harmaa	Ljus grå	Light grey		2700	 6 4 17083 651519
6515-WHITE	Valkoinen	Vit	White		2700	 6 4 17083 651595

**LAATTALISTAT**  
**KAKELLISTER**  
 TILE TRIMS

**muoviset**  
 av plast  
 plastic

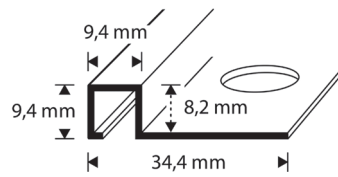

6516-WHITE





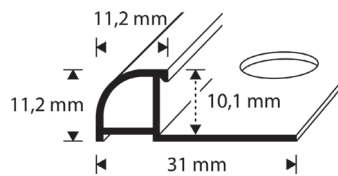





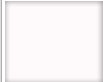

H=8 mm Neliö | Kvadrat | Square

TUOTENRO PRODUKTNR PRODUCT NO	VÄRI	FÄRG	COLOUR		PITUUS LÄNGD LENGTH	EAN-KOODI EAN-KOD EAN-CODE
6516-WHITE	Valkoinen	Vit	White		2700	 6 417083 020377

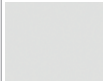

6520-BLACK

H=10 mm Pyöreä | Rund | Circular

TUOTENRO PRODUKTNR PRODUCT NO	VÄRI	FÄRG	COLOUR		PITUUS LÄNGD LENGTH	EAN-KOODI EAN-KOD EAN-CODE
6520-BEIGE	Beige	Beige	Beige		2700	 6 417083 652042
6520-BLACK	Musta	Svart	Black		2700	 6 417083 652035
6520-BROKEN WHITE	Maalarinvalkoinen	Bruten vit	Broken white		2700	 6 417083 652004
6520-GREY	Keskiharmaa	Grå	Grey		2700	 6 417083 652028
6520-LIGHT GREY	Vaalean harmaa	Ljus grå	Light grey		2700	 6 417083 652011
6520-WHITE	Valkoinen	Vit	White		2700	 6 417083 652097

**muoviset**  
av plast  
plastic

**LAATTALISTAT**  
**KAKELLISTER**  
TILE TRIMS

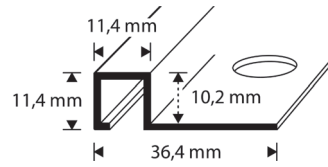

6121-WHITE





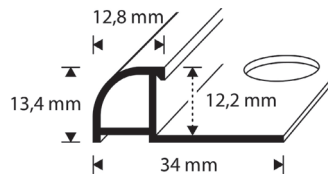







H=10 mm Neliö | Kvadrat | Square

TUOTENRO PRODUKTNR PRODUCT NO	VÄRI	FÄRG	COLOUR		PITUUS LÄNGD LENGTH	EAN-KOODI EAN-KOD EAN-CODE
6521-WHITE	Valkoinen	Vit	White		2700	 6 4 17083 020384

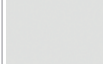

6525-BEIGE

H=12 mm Pyöreä | Rund | Circular

TUOTENRO PRODUKTNR PRODUCT NO	VÄRI	FÄRG	COLOUR		PITUUS LÄNGD LENGTH	EAN-KOODI EAN-KOD EAN-CODE
6525-BEIGE	Beige	Beige	Beige		2700	 6 4 17083 652547
6525-BLACK	Musta	Svart	Black		2700	 6 4 17083 652530
6525-BROKEN WHITE	Maalarinvalkoinen	Bruten vit	Broken white		2700	 6 4 17083 652509
6525-GREY	Keskiharmaa	Grå	Grey		2700	 6 4 17083 652523
6525-LIGHT GREY	Vaalean harmaa	Ljus grå	Light grey		2700	 6 4 17083 652516
6525-WHITE	Valkoinen	Vit	White		2700	 6 4 17083 652592

**LAATTALISTAT**  
**KAKELLISTER**  
 TILE TRIMS

**päätelistat, metalliset**  
 avslutningsprofiler, av metall  
 finishing profiles, metal

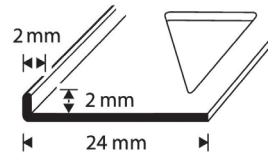

H=2 mm Päätelista | Avslutningsprofil | Finishing profile

TUOTENRO PRODUKTNR PRODUCT NO	VÄRI	FÄRG	COLOUR		PITUUS LÄNGD LENGTH	EAN-KOODI EAN-KOD EAN-CODE
AE 20	Hopea-anodisoitu	Silver anodiserad	Silver anodized		2500	 6 417083 039768

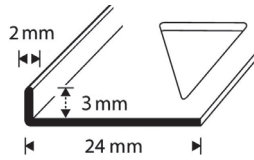

A 30

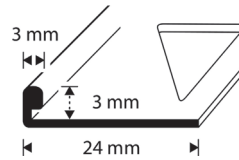

E 30, M 30

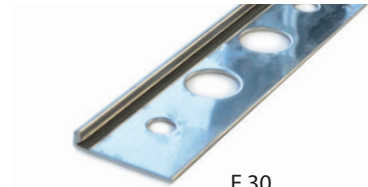

E 30

H=3 mm Päätelista | Avslutningsprofil | Finishing profile

TUOTENRO PRODUKTNR PRODUCT NO	VÄRI	FÄRG	COLOUR		PITUUS LÄNGD LENGTH	EAN-KOODI EAN-KOD EAN-CODE
A 30	Alumiini	Aluminium	Aluminium		2500	 6 417083 300103
E 30	RST	Rostfritt stål	Stainless steel		2500	 6 417083 000300
M 30	Messinki	Mässing	Brass		2500	 6 417083 300400

**päätelistat, metalliset**  
avslutningsprofiiler, av metall  
finishing profiles, metal

**LAATTALISTAT**  
**KAKELLISTER**  
TILE TRIMS

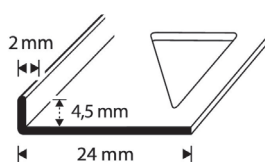

A 45, AE 45

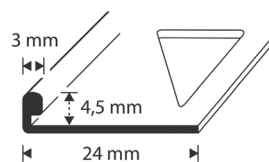

E 45, M 45



A 45

H=4,5 mm Päätelista | Avslutningsprofil | Finishing profile

TUOTENRO PRODUKTNR PRODUCT NO	VÄRI	FÄRG	COLOUR		PITUUS LÄNGD LENGTH	EAN-KOODI EAN-KOD EAN-CODE
A 45	Alumiini	Aluminium	Aluminium		2500	 6 4 17083 450105
AE 45	Hopea-anodisoitu	Silver anodiserad	Silver anodized		2500	 6 4 17083 026249
E 45	RST	Rostfritt stål	Stainless steel		2500	 6 4 17083 450501
M 45	Messinki	Mässing	Brass		2500	 6 4 17083 450402

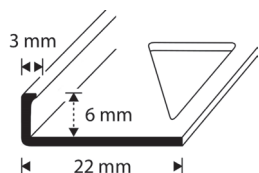

A 60, AE 60

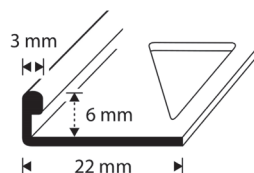

E 60, M 60

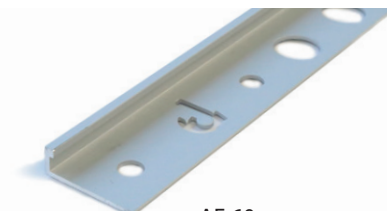

AE 60

H=6 mm Päätelista | Avslutningsprofil | Finishing profile

TUOTENRO PRODUKTNR PRODUCT NO	VÄRI	FÄRG	COLOUR		PITUUS LÄNGD LENGTH	EAN-KOODI EAN-KOD EAN-CODE
A 60	Alumiini	Aluminium	Aluminium		2500	 6 4 17083 600104
AE 60	Hopea-anodisoitu	Silver anodiserad	Silver anodized		2500	 6 4 17083 600203
E 60	RST	Rostfritt stål	Stainless steel		2500	 6 4 17083 600500
M 60	Messinki	Mässing	Brass		2500	 6 4 17083 600401

**LAATTALISTAT**  
**KAKELLISTER**  
 TILE TRIMS

**päätelistat, metalliset**  
 avslutningsprofiiler, av metall  
 finishing profiles, metal

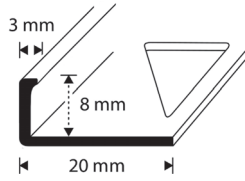

A – AWSR 80

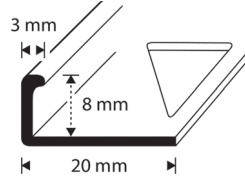

E 80, M 80



AGRR 80

H=8 mm Päätelista | Avslutningsprofil | Finishing profile

TUOTENRO PRODUKTNR PRODUCT NO	VÄRI	FÄRG	COLOUR		PITUUS LÄNGD LENGTH	EAN-KOODI EAN-KOD EAN-CODE
A 80	Alumiini	Aluminium	Aluminium		2500	6 417083 080111
ABS 80	Kromi-anodisoitu	Krom anodiserad	Chrome anodized		2500	6 417083 041600
ACBL 80	Carbon black	Carbon black	Carbon black		2500	6 417083 035791
AGRR 80	Grey rustic	Grey rustic	Grey rustic		2500	6 417083 041365
AE 80	Hopea-anodisoitu	Silver anodiserad	Silver anodized		2500	6 417083 080203
AMUR 80	Mud rustic	Mud rustic	Mud rustic		2500	6 417083 041372
ANG 80	Nordic graphite	Nordisk grafit	Nordic graphite		2500	6 417083 035807
ASAR 80	Sand rustic	Sand rustic	Sand rustic		2500	6 417083 041389
AW 80	Maalattu valkoinen	Vitmålad	Painted white		2500	6 417083 022937
AWSR 80	White sand rustic	White sand rustic	White sand rustic		2500	6 417083 041785
E 80	RST	Rostfritt stål	Stainless steel		2500	6 417083 080500
M 80	Messinki	Mässing	Brass		2500	6 417083 080401

**Nordic Graphite** -värisävy saattaa vaihdella valmistuksessa käytettävän harjaustekniikan vuoksi.  
 Nyanssen **Nordic Graphite** kan variera beroende på den borstningsteknik som används vid tillverkningen.  
 The **Nordic Graphite** shade may vary according to the brushing technique used in manufacturing.

**päätelistat, metalliset**  
avslutningsprofiiler, av metall  
finishing profiles, metal

**LAATTALISTAT**  
**KAKELLISTER**  
TILE TRIMS

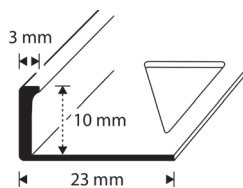

A – AWSR 100, M 100

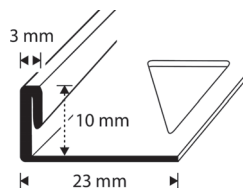

E 100



AMUR 100

H=10 mm Päätelista | Avslutningsprofil | Finishing profile

TUOTENRO PRODUKTNR PRODUCT NO	VÄRI	FÄRG	COLOUR		PITUUS LÄNGD LENGTH	EAN-KOODI EAN-KOD EAN-CODE
A 100	Alumiini	Aluminium	Aluminium		2500	
ABS 100	Kromi-anodisoitu	Krom anodiserad	Chrome anodized		2500	
ACBL 100	Carbon black	Carbon black	Carbon black		2500	
AGRR 100	Grey rustic	Grey rustic	Grey rustic		2500	
AE 100	Hopea-anodisoitu	Silver anodiserad	Silver anodized		2500	
AMUR 100	Mud rustic	Mud rustic	Mud rustic		2500	
ANG 100	Nordic graphite	Nordisk grafit	Nordic graphite		2500	
ASAR 100	Sand rustic	Sand rustic	Sand rustic		2500	
AW 100	Maalattu valkoinen	Vitmålad	Painted white		2500	
AWSR 100	White sand rustic	White sand rustic	White sand rustic		2500	
E 100	RST	Rostfritt stål	Stainless steel		2500	
M 100	Messinki	Mässing	Brass		2500	

**Nordic Graphite** -värisävy saattaa vaihdella valmistuksessa käytettävän harjaustekniikan vuoksi.  
Nyanssen **Nordic Graphite** kan variera beroende på den borstningsteknik som används vid tillverkningen.  
The **Nordic Graphite** shade may vary according to the brushing technique used in manufacturing.

LAATTALISTAT  
KAKELLISTER  
TILE TRIMS

päätelistat, metalliset  
avslutningsprofiler, av metall  
finishing profiles, metal

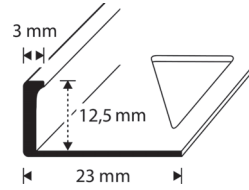

A-AWSR 125, M 125

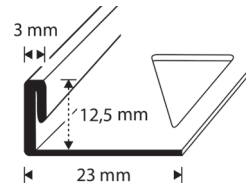

E 125



AWSR 125

H=12,5 mm Päätelista | Avslutningsprofil | Finishing profile

TUOTENRO PRODUKTNR PRODUCT NO	VÄRI	FÄRG	COLOUR		PITUUS LÄNGD LENGTH	EAN-KOODI EAN-KOD EAN-CODE
A 125	Alumiini	Aluminium	Aluminium		2500	6 417 083 125010
ABS 125	Kromi-anodisoitu	Krom anodiserad	Chrome anodized		2500	6 417 083 041624
ACBL 125	Carbon black	Carbon black	Carbon black		2500	6 417 083 041594
AGRR 125	Grey rustic	Grey rustic	Grey rustic		2500	6 417 083 041426
AE 125	Hopea-anodisoitu	Silver anodiserad	Silver anodized		2500	6 417 083 125201
AMUR 125	Mud rustic	Mud rustic	Mud rustic		2500	6 417 083 041433
ANG 125	Nordic graphite	Nordisk grafit	Nordic graphite		2500	6 417 083 041587
ASAR 125	Sand rustic	Sand rustic	Sand rustic		2500	6 417 083 041440
AW 125	Maalattu valkoinen	Vitmålad	Painted white		2500	6 417 083 022951
AWSR 125	White sand rustic	White sand rustic	White sand rustic		2500	6 417 083 041808
E 125	RST	Rostfritt stål	Stainless steel		2500	6 417 083 125508
M 125	Messinki	Mässing	Brass		2500	6 417 083 125409

**Nordic Graphite** -värisävy saattaa vaihdella valmistuksessa käytettävän harjaustekniikan vuoksi.  
Nyanssen **Nordic Graphite** kan variera beroende på den borstningsteknik som används vid tillverknigen.  
The **Nordic Graphite** shade may vary according to the brushing technique used in manufacturing.

**päätelistat, metalliset**  
**avslutningsprofiiler, av metall**  
 finishing profiles, metal

**LAATTALISTAT**  
**KAKELLISTER**  
 TILE TRIMS

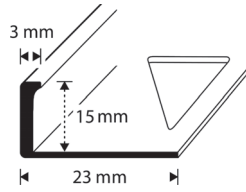

A-AWSR 150, M 150

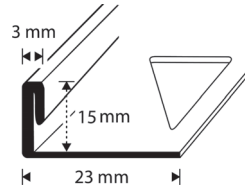









E 150



E 150

H=15 mm Päätelista | Avslutningsprofil | Finishing profile

TUOTENRO PRODUKTNR PRODUCT NO	VÄRI	FÄRG	COLOUR		PITUUS LÄNGD LENGTH	EAN-KOODI EAN-KOD EAN-CODE
A 150	Alumiini	Aluminium	Aluminium		2500	 6 4 17083 150104
AE 150	Hopea-anodisoitu	Silver anodiserad	Silver anodized		2500	 4 021651 135909
E 150	RST	Rostfritt stål	Stainless steel		2500	 6 4 17083 150500
M 150	Messinki	Mässing	Brass		2500	 6 4 17083 150401

**LAATTALISTAT**  
**KAKELLISTER**  
 TILE TRIMS

**päätelistat, muoviset**  
**avslutningsprofiler, av plast**  
 finishing profiles, plastic

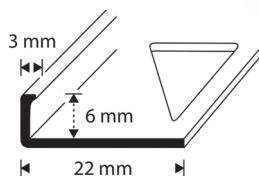

PWH 60

H=6 mm Päätelista, muovi | Avslutningsprofil, plast | Finishing profile, plastic

TUOTENRO PRODUKTNR PRODUCT NO	VÄRI	FÄRG	COLOUR		PITUUS LÄNGD LENGTH	EAN-KOODI EAN-KOD EAN-CODE
PLG 60	Vaalean harmaa	Ljus grå	Light grey		2500	6 417083 022012
PWH 60	Valkoinen	Vit	White		2500	6 417083 022005

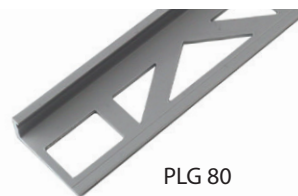
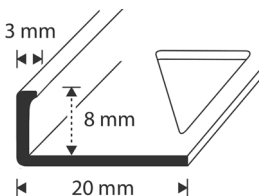

PLG 80

H=8 mm Päätelista, muovi | Avslutningsprofil, plast | Finishing profile, plastic

TUOTENRO PRODUKTNR PRODUCT NO	VÄRI	FÄRG	COLOUR		PITUUS LÄNGD LENGTH	EAN-KOODI EAN-KOD EAN-CODE
PLG 80	Vaalean harmaa	Ljus grå	Light grey		2500	6 417083 022036
PWH 80	Valkoinen	Vit	White		2500	6 417083 022029

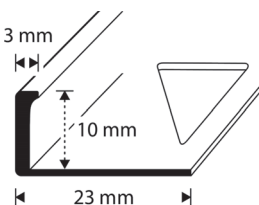

PWH 100

H=10 mm Päätelista, muovi | Avslutningsprofil, plast | Finishing profile, plastic

TUOTENRO PRODUKTNR PRODUCT NO	VÄRI	FÄRG	COLOUR		PITUUS LÄNGD LENGTH	EAN-KOODI EAN-KOD EAN-CODE
PLG 100	Vaalean harmaa	Ljus grå	Light grey		2500	6 417083 022050
PWH 100	Valkoinen	Vit	White		2500	6 417083 022043

**päätelistat, MDF ja tammi**  
avslutningsprofiler, MDF och ek  
finishing profiles, MDF and oak

**LAATTALISTAT**  
**KAKELLISTER**  
TILE TRIMS

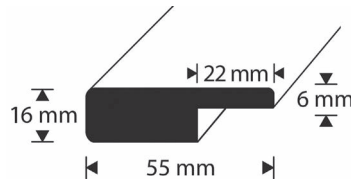

H=55 mm Päätelista | Avslutningsprofil | Finishing profile

TUOTENRO PRODUKTNR PRODUCT NO	VÄRI	FÄRG	COLOUR		PITUUS LÄNGD LENGTH	EAN-KOODI EAN-KOD EAN-CODE
WO55 MDF ●	Maalattu valkoinen	Vitmålrad	Painted white		2400	6 4 17083 19 1459
WO55 OAK* ●	Lakattu tammi	Lackad ek	Lacquered oak		2400	6 4 17083 19 1473

- **Poistuva tuote.** Kysy lisää myynnistä
- **Utgående produkt.** Fråga mer hos försäljningen
- **Discontinued product.** Contact sales for more information

\*) **WO55 OAK** FSC®-sertifioitu Dione-jalopuulista / FSC®-certifierade Dione trälist / FSC®-certified Dione wood trim

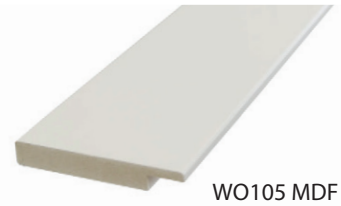
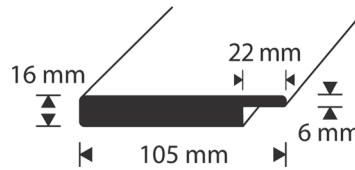

H=105 mm Päätelista | Avslutningsprofil | Finishing profile

TUOTENRO PRODUKTNR PRODUCT NO	VÄRI	FÄRG	COLOUR		PITUUS LÄNGD LENGTH	EAN-KOODI EAN-KOD EAN-CODE
WO105 MDF ●	Maalattu valkoinen	Vitmålrad	Painted white		2400	6 4 17083 19 1466
WO105 OAK* ●	Lakattu tammi	Lackad ek	Lacquered oak		2400	6 4 17083 19 1480

- **Poistuva tuote.** Kysy lisää myynnistä
- **Utgående produkt.** Fråga mer hos försäljningen
- **Discontinued product.** Contact sales for more information



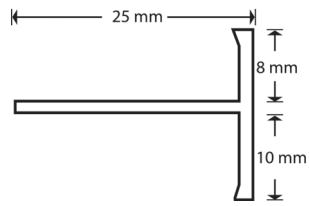

\*) **WO105 OAK** FSC®-sertifioitu Dione-jalopuulista / FSC®-certifierade Dione trälist / FSC®-certified Dione wood trim

**LAATTALISTAT**  
**KAKELLISTER**  
 TILE TRIMS



T8-10 HE



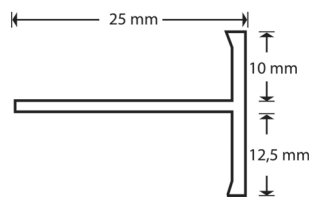

H=8/10 mm T-lista, epäsymmetrinen | T-profil, asymmetrisk | T-profile, asymmetric

TUOTENRO PRODUKTNR PRODUCT NO	VÄRI	FÄRG	COLOUR		PITUUS LÄNGD LENGTH	EAN-KOODI EAN-KOD EAN-CODE
T8-10 BS	Kromi-anodisoitu	Krom anodiserad	Chrome anodized		2500	 6 417 083 035746
T8-10 HE	Hopea-anodisoitu	Silver anodiserad	Silver anodized		2500	 6 417 083 035739



T10-12 BS

H=8/10 mm T-lista, epäsymmetrinen | T-profil, asymmetrisk | T-profile, asymmetric

TUOTENRO PRODUKTNR PRODUCT NO	VÄRI	FÄRG	COLOUR		PITUUS LÄNGD LENGTH	EAN-KOODI EAN-KOD EAN-CODE
T10-12 BS	Kromi-anodisoitu	Krom anodiserad	Chrome anodized		2500	 6 417 083 035760
T10-12 HE	Hopea-anodisoitu	Silver anodiserad	Silver anodized		2500	 6 417 083 035753

**LAATTALISTAT**  
**KAKELLISTER**  
 TILE TRIMS

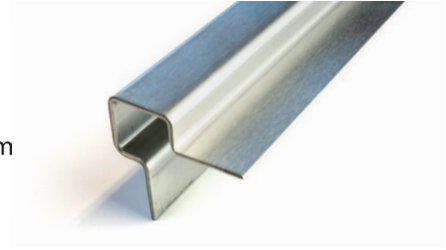
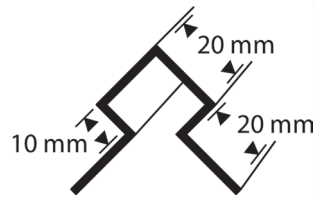

20 x 20 mm H=10 mm Laatta-askelkulma | Kakellist trappkant | Tile trim stair edge

TUOTENRO PRODUKTNR PRODUCT NO	VÄRI	FÄRG	COLOUR		PITUUS LÄNGD LENGTH	EAN-KOODI EAN-KOD EAN-CODE
E 20-10	RST	Rostfritt stål	Stainless steel		3000	 6 4 17083 020100

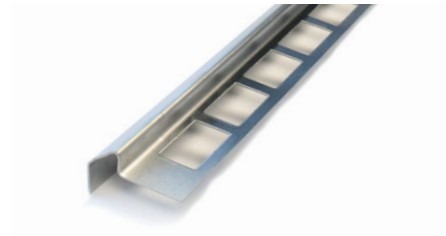
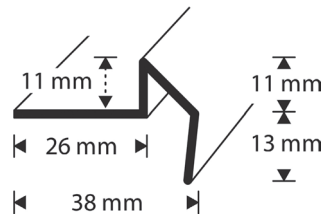

H=10 mm Laatta-askelkulma | Kakellist trappkant | Tile trim stair edge

TUOTENRO PRODUKTNR PRODUCT NO	VÄRI	FÄRG	COLOUR		PITUUS LÄNGD LENGTH	EAN-KOODI EAN-KOD EAN-CODE
65210	RST	Rostfritt stål	Stainless steel		2500	 6 4 17083 652103

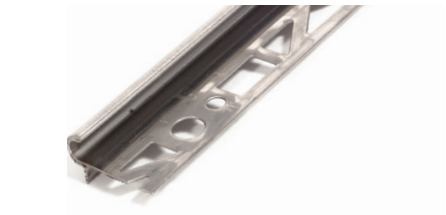
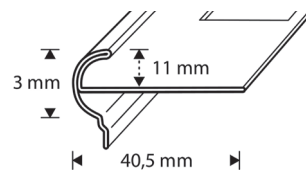

H=11 mm Laatta-askelkulma | Kakellist trappkant | Tile trim stair edge

TUOTENRO PRODUKTNR PRODUCT NO	VÄRI	FÄRG	COLOUR		PITUUS LÄNGD LENGTH	EAN-KOODI EAN-KOD EAN-CODE
6580-RST	RST	Rostfritt stål	Stainless steel		2500	 6 4 17083 658006

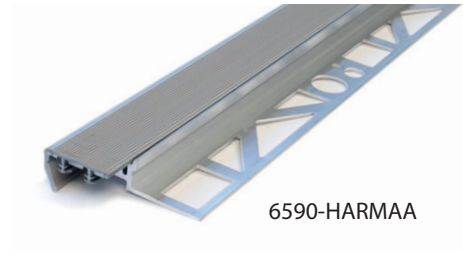
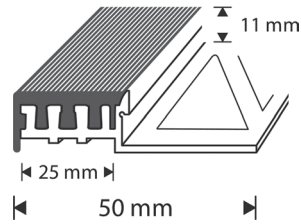

**LAATTALISTAT**  
**KAKELLISTER**  
 TILE TRIMS

**askelkulmat**  
**trappkanter**  
 stair edges



6590-HARMAA

H=11 mm Laatta-askelkulma liukuesteellä | Kakellist trappkant med PVC inlägg  
 Tile trim stair edge with PVC anti-slip

TUOTENRO PRODUKTNR PRODUCT NO	VÄRI	FÄRG	COLOUR		PITUUS LÄNGD LENGTH	EAN-KOODI EAN-KOD EAN-CODE
6590-BLACK	Musta	Svart	Black		2500	
6590-BEIGE	Beige	Beige	Beige		2500	
6590-HARMAA	Keskiharmaa	Grå	Grey		2500	



**65210**  
 sivu/sidan/page 201

Laattalistat  
 Kakellister  
 Tile trims

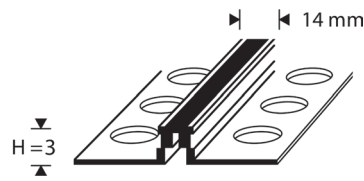

LS 30 RST GREY

H=3 mm Liikuntasaumalista | Expansionsfog | Expansion joint profile

TUOTENRO PRODUKTNR PRODUCT NO	VÄRI	FÄRG	COLOUR		PITUUS LÄNGD LENGTH	EAN-KOODI EAN-KOD EAN-CODE
LS 30 AL GREY	Alumiini	Aluminium	Aluminium		2500	 6 4 17083 022067
LS 30 RST GREY	RST	Rostfritt stål	Stainless steel		2500	 6 4 17083 021497

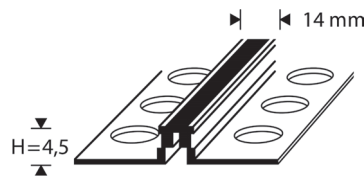

LS 45 AL GREY

H=4,5 mm Liikuntasaumalista | Expansionsfog | Expansion joint profile

TUOTENRO PRODUKTNR PRODUCT NO	VÄRI	FÄRG	COLOUR		PITUUS LÄNGD LENGTH	EAN-KOODI EAN-KOD EAN-CODE
LS 45 AL GREY	Alumiini	Aluminium	Aluminium		2500	 6 4 17083 023590
LS 45 RST GREY	RST	Rostfritt stål	Stainless steel		2500	 6 4 17083 032493

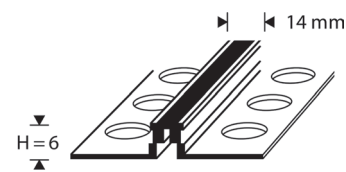

LS 60 RST GREY

H=6 mm Liikuntasaumalista | Expansionsfog | Expansion joint profile

TUOTENRO PRODUKTNR PRODUCT NO	VÄRI	FÄRG	COLOUR		PITUUS LÄNGD LENGTH	EAN-KOODI EAN-KOD EAN-CODE
LS 60 AL GREY	Alumiini	Aluminium	Aluminium		2500	 6 4 17083 032486
LS 60 RST GREY	RST	Rostfritt stål	Stainless steel		2500	 6 4 17083 032509

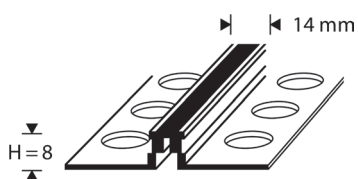

LS 80 AL GREY

H=8 mm Liikuntasaumalista | Expansionsfog | Expansion joint profile

TUOTENRO PRODUKTNR PRODUCT NO	VÄRI	FÄRG	COLOUR		PITUUS LÄNGD LENGTH	EAN-KOODI EAN-KOD EAN-CODE
LS 80 AL GREY	Alumiini	Aluminium	Aluminium		2500	 6 417083 800016
LS 80 RST GREY	RST	Rostfritt stål	Stainless steel		2500	 6 417083 032516

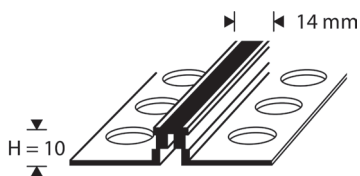

LS 100 RST GREY

H=10 mm Liikuntasaumalista | Expansionsfog | Expansion joint profile

TUOTENRO PRODUKTNR PRODUCT NO	VÄRI	FÄRG	COLOUR		PITUUS LÄNGD LENGTH	EAN-KOODI EAN-KOD EAN-CODE
LS 100 AL GREY	Alumiini	Aluminium	Aluminium		2500	 6 417083 100017
LS 100 RST GREY	RST	Rostfritt stål	Stainless steel		2500	 6 417083 270529

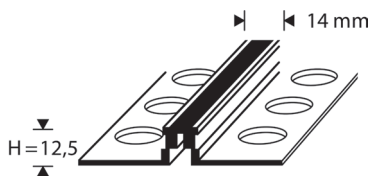

LS 125 AL GREY





H=12,5 mm Liikuntasaumalista | Expansionsfog | Expansion joint profile

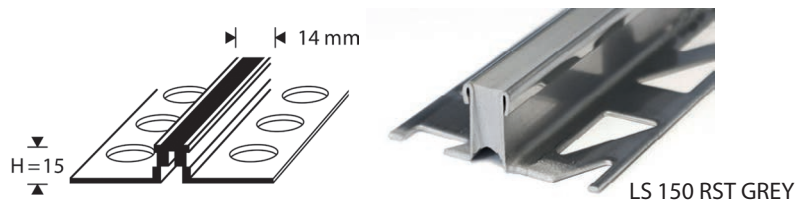

TUOTENRO PRODUKTNR PRODUCT NO	VÄRI	FÄRG	COLOUR		PITUUS LÄNGD LENGTH	EAN-KOODI EAN-KOD EAN-CODE
LS 125 AL GREY	Alumiini	Aluminium	Aluminium		2500	 6 417083 032462
LS 125 RST GREY	RST	Rostfritt stål	Stainless steel		2500	 6 417083 270512

**liikuntasaumat**  
expansionsfogar  
expansion joints

**LAATTALISTAT**  
KAKELLISTER  
TILE TRIMS



H=15 mm Liikuntasaumalista   Expansionsfog   Expansion joint profile						
TUOTENRO PRODUKTNR PRODUCT NO	VÄRI	FÄRG	COLOUR		PITUUS LÄNGD LENGTH	EAN-KOODI EAN-KOD EAN-CODE
LS 150 AL GREY	Alumiini	Aluminium	Aluminium		2500	 6 4 17083 032479
LS 150 RST GREY	RST	Rostfritt stål	Stainless steel		2500	 6 4 17083 032523

-  Suojaamattomat liikuntasaumot laatoituksessa ovat alttiina rikkoutumiselle ja hiushalkeamille. Pääte -ja liikuntasaumalistoilla suojaat laatoituksen liikuntasaumot tyylikkäästi liikkumisen aiheuttamilta vahingoilta.
-  Oskyddade rörelsefogar råkar ofta ut för skador och småsprickor. Rörelsefogar i kakel/klinker skyddas elegant mot rörelseskador med avslutningsprofiler och expansionsfogar. Tillsammans med elastisk fogmassa ger avslutningsprofilerna en prydlig och hållbar finish.
-  Unprotected expansion joints are prone to breakage and hairline fractures. Finishing and expansion joint profiles offer the tiling expansion gaps elegant protection against damage caused by movement.

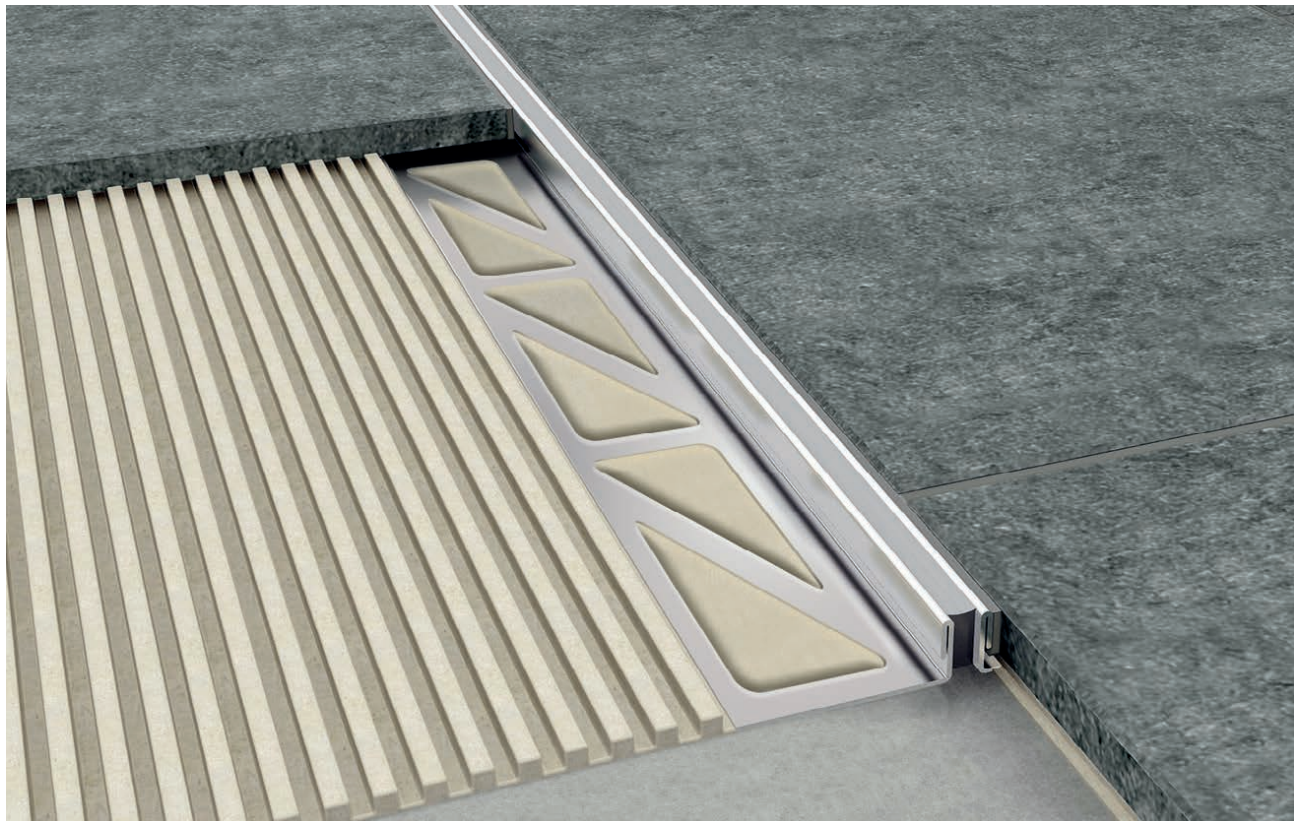

**MÄRKÄTILAN TUOTTEET**  
**VÄTRUMSPRODUKTER**  
**WET ROOM PRODUCTS**

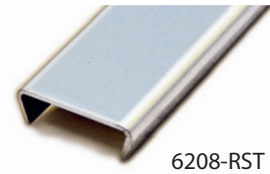
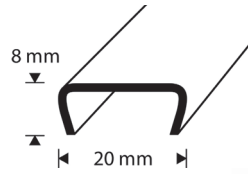

6208-RST

Boordilista | Dekorlist | Tile border

TUOTENRO PRODUKTNR PRODUCT NO	VÄRI	FÄRG	COLOUR		PITUUS LÄNGD LENGTH	EAN-KOODI EAN-KOD EAN-CODE
6208-RST ●	RST	Rostfritt stål	Stainless steel		2500	6 417083 017902
6208-RST HI ●	RST	Rostfritt stål	Stainless steel		2500	6 417083 018466

- **Poistuva tuote.** Kysy lisää myynnistä
- **Utgående produkt.** Fråga mer hos försäljningen
- **Discontinued product.** Contact sales for more information

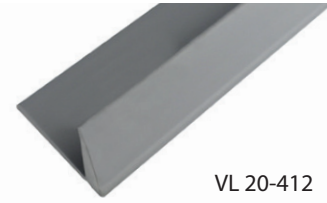

VL 20-412

Vesilista | Vattenprofil | Waterstop profile

TUOTENRO PRODUKTNR PRODUCT NO	VÄRI	FÄRG	COLOUR		PITUUS LÄNGD LENGTH	EAN-KOODI EAN-KOD EAN-CODE
VL 20-412	Vaalean harmaa	Ljus grå	Light grey		2500	6 417083 022654
VL 20-414	Keskiharmaa	Grå	Grey		2500	6 417083 022524
VL 20-418	Tummanharmaa	Mörk grå	Dark grey		2500	6 417083 022531
VL 20-470	Musta	Svart	Black		2500	6 417083 022647

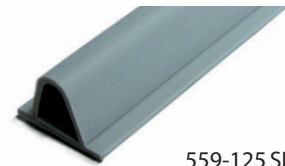
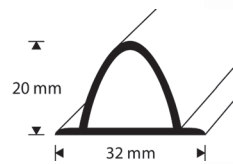

559-125 SINIHARMAA

32 x 20 mm Suihkulista | Duschprofil | Shower profile

TUOTENRO PRODUKTNR PRODUCT NO	VÄRI	FÄRG	COLOUR		PITUUS LÄNGD LENGTH	EAN-KOODI EAN-KOD EAN-CODE
559-125 SINIHARMAA	Siniharmaa	Blå grå	Blue-grey		1250	6 417083 559433
559-125 VALKOINEN	Valkoinen	Vit	White		1250	6 417083 559440
559-SINIHARM	Siniharmaa	Blå grå	Blue-grey		2500	6 417083 559402
559-VALK	Valkoinen	Vit	White		2500	6 417083 559419

# OVI- JA IKKUNATUOTTEET DÖRR- OCH FÖNSTERPRODUKTER DOOR AND WINDOW PRODUCTS

## VIIMEISTELE KYNNYKSILLÄ. LUO ILMETTÄ IKKUNALAUOILLA.

Valikoimastamme löydät vesieristekynnykset, FSC®-sertifioidut tammikynnykset ja muut kynnystuotteet. Muoviset peite- ja viimeistelylistat sekä RST-potkupellit soveltuvat kovaankin käyttöön. Laadukkaita ikkunautoja on tarjolla kahdessa eri profiilissa ja useissa pituuksissa.

## FÄRDIGSTÄLL MED TRÖSKLAR. SKAPA ETT ENHETLIGT UTTRYCK MED FÖNSTERBÄNKAR.

Sortimentet omfattar trösklar för våtrum, FSC®-certifierade ektrösklar samt övriga tröskelprodukter. Plastbaserade täck- och avslutningslister samt sparkplåtar i rostfritt stål är anpassade för krävande användning. Fönsterbänkar av hög kvalitet finns i två olika profiler och i flera längder.





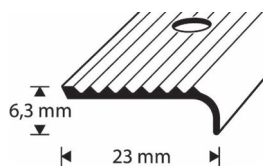

## FINISH WITH THRESHOLDS. COMPLETE THE LOOK WITH WINDOWSILLS.

The assortment includes thresholds for wet rooms, FSC®-certified oak thresholds and other threshold products. Plastic cover and finishing profiles as well as stainless steel kick plates are suitable for demanding use. High-quality windowsills are available in two different profiles and in a range of lengths.

**KYNNYSLISTAT**  
**TRÖSKELLISTER**  
**THRESHOLDS**



23 mm H=6,3 mm Uritettu, messinki | Spårad, mässing | Grooved, brass

TUOTENRO PRODUKTNR PRODUCT NO	VÄRI	FÄRG	COLOUR		PITUUS LÄNGD LENGTH	EAN-KOODI EAN-KOD EAN-CODE
C10 M1	Messinki	Mässing	Brass		1000	 6 417083 026812
C10 M2	Messinki	Mässing	Brass		2000	 6 417083 026829
C10 M3	Messinki	Mässing	Brass		3000	 6 417083 026836

# MUOVIKYNNYKSET TRÖSKLAR AV PLAST PLASTIC THRESHOLDS

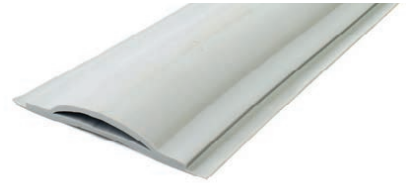
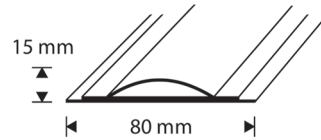

## 80 mm H=15 mm Joustokynnys, muovi | Flexibla trösklar, plast | Flexible threshold, plastic

TUOTENRO PRODUKTNR PRODUCT NO	VÄRI	FÄRG	COLOUR		PITUUS LÄNGD LENGTH	EAN-KOODI EAN-KOD EAN-CODE
1010-HARMAA	Vaalean harmaa	Ljus grå	Light Grey		1 m	
1010-HARMAA RULLA	Vaalean harmaa	Ljus grå	Light Grey		20 m	
1011	Väritön sulkijatulppa 1010-listaan	Tätningsplugg för tröskel 1010	Plug for threshold 1010			

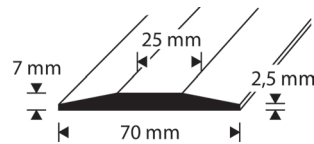

## 70 mm H=7 mm Kynnyslista, muovi | Tröskel, plast | Threshold, plastic

TUOTENRO PRODUKTNR PRODUCT NO	VÄRI	FÄRG	COLOUR		PITUUS LÄNGD LENGTH	EAN-KOODI EAN-KOD EAN-CODE
KY 70-412	Vaalean harmaa	Ljus grå	Light grey		25000	

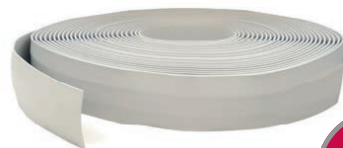
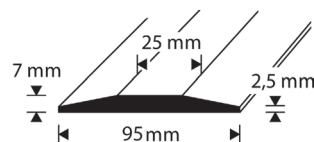

## 95 mm H=7 mm Kynnyslista, muovi | Tröskel, plast | Threshold, plastic

TUOTENRO PRODUKTNR PRODUCT NO	VÄRI	FÄRG	COLOUR		PITUUS LÄNGD LENGTH	EAN-KOODI EAN-KOD EAN-CODE
KY 95-412	Vaalean harmaa	Ljus grå	Light grey		25000	

**VESIERISTEKYNNYKSET**  
**TRÖSKLAR FÖR VÅTRUM**  
**THRESHOLDS FOR WET ROOMS**

**karmien väliin asennettavat**  
**för monterade karmar**  
**for pre-installed door frames**

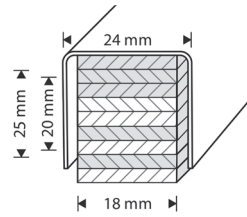

M7K NG



25 x 24 mm Vesieristekynnys + vaneri | Tröskel + plywood | Threshold + plywood

TUOTENRO PRODUKTNR PRODUCT NO	VÄRI	FÄRG	COLOUR		PITUUS LÄNGD LENGTH	EAN-KOODI EAN-KOD EAN-CODE
M7K RST	RST	Rostfritt stål	Stainless steel		700	 6 417 083 022500
M7K CBL	Carbon black	Carbon black	Carbon black		700	 6 417 083 025150
M7K NG	Nordic Graphite	Nordic Graphite	Nordic Graphite		700	 6 417 083 025167
M10K RST	RST	Rostfritt stål	Stainless steel		1000	 6 417 083 022517
M10K CBL	Carbon black	Carbon black	Carbon black		1000	 6 417 083 025174
M10K NG	Nordic Graphite	Nordic Graphite	Nordic Graphite		1000	 6 417 083 025181

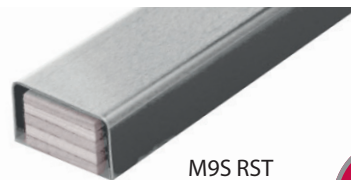
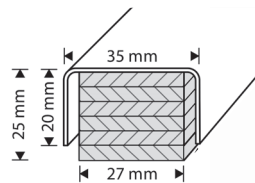

M9S RST



25 x 35 mm Vesieristekynnys + vaneri | Tröskel + plywood | Threshold + plywood

TUOTENRO PRODUKTNR PRODUCT NO	VÄRI	FÄRG	COLOUR		PITUUS LÄNGD LENGTH	EAN-KOODI EAN-KOD EAN-CODE
M9S RST	RST	Rostfritt stål	Stainless steel		806	 6 417 083 020643
M9S CBL	Carbon black	Carbon black	Carbon black		806	 6 417 083 025198
M9S NG	Nordic graphite	Nordisk grafit	Nordic graphite		806	 6 417 083 025204
M10S RST	RST	Rostfritt stål	Stainless steel		906	 6 417 083 020650
M10S CBL	Carbon black	Carbon black	Carbon black		906	 6 417 083 025211
M10S NG	Nordic graphite	Nordisk grafit	Nordic graphite		906	 6 417 083 025228

**karmi in lovettavat**  
skåras för karmar  
notch to fit door frame

**VESIERISTEKYNNYKSET**  
TRÖSKLAR FÖR VÅTRUM  
THRESHOLDS FOR WET ROOMS

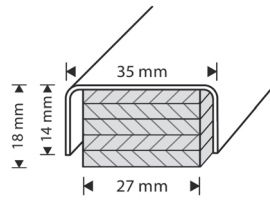

18 x 35 mm Vesieristekynnys + vaneri | Tröskel + plywood | Threshold + plywood

TUOTENRO PRODUKTNR PRODUCT NO	VÄRI	FÄRG	COLOUR		PITUUS LÄNGD LENGTH	EAN-KOODI EAN-KOD EAN-CODE
M9ES RST	RST	Rostfritt stål	Stainless steel		920	 6 4 17083 042157
M10ES RST	RST	Rostfritt stål	Stainless steel		1020	 6 4 17083 042164

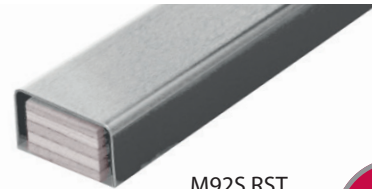
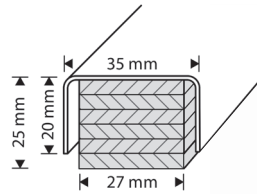

M92S RST



25 x 35 mm Vesieristekynnys + vaneri | Tröskel + plywood | Threshold + plywood

TUOTENRO PRODUKTNR PRODUCT NO	VÄRI	FÄRG	COLOUR		PITUUS LÄNGD LENGTH	EAN-KOODI EAN-KOD EAN-CODE
M92S RST	RST	Rostfritt stål	Stainless steel		920	 6 4 17083 042171
M92S CBL	Carbon black	Carbon black	Carbon black		920	 6 4 17083 042607
M92S NG	Nordic Graphite	Nordic Graphite	Nordic Graphite		920	 6 4 17083 042614
M102S RST	RST	Rostfritt stål	Stainless steel		1020	 6 4 17083 042188
M102S CBL	Carbon black	Carbon black	Carbon black		1020	 6 4 17083 042621
M102S NG	Nordic Graphite	Nordic Graphite	Nordic Graphite		1020	 6 4 17083 042638

**Nordic Graphite** -väriseävy saattaa vaihdella valmistuksessa käytettävän harjaustekniikan vuoksi.  
Nyansen **Nordic Graphite** kan variera beroende på den borstningsteknik som används vid tillverkningen.  
The **Nordic Graphite** shade may vary according to the brushing technique used in manufacturing.

**VESIERISTEKYNNYKSET**  
**TRÖSKLAR FÖR VÅTRUM**  
**THRESHOLDS FOR WET ROOMS**

**ennen karmeja asennettavat**  
**monteras före karmar**  
**installed before door frames**

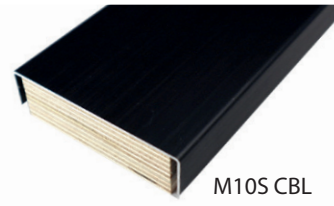
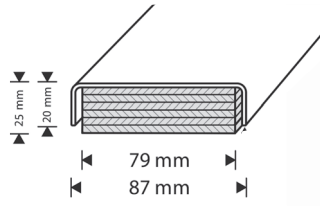

25 x 87 mm Vesieristekynnys + vaneri | Tröskel + plywood | Threshold + plywood

TUOTENRO PRODUKTNR PRODUCT NO	VÄRI	FÄRG	COLOUR		PITUUS LÄNGD LENGTH	EAN-KOODI EAN-KOD EAN-CODE
M9U RST	RST	Rostfritt stål	Stainless steel		890	 6 4 1 7 0 8 3 0 2 0 6 6 7
M9U CBL	Carbon Black	Carbon Black	Carbon Black		890	 6 4 1 7 0 8 3 0 2 5 2 3 5
M9U NG	Nordic Graphite	Nordic Graphite	Nordic Graphite		890	 6 4 1 7 0 8 3 0 2 5 2 4 2
M10U RST	RST	Rostfritt stål	Stainless steel		990	 6 4 1 7 0 8 3 0 2 0 6 7 4
M10U CBL	Carbon Black	Carbon Black	Carbon Black		990	 6 4 1 7 0 8 3 0 2 5 2 5 9
M10U NG	Nordic Graphite	Nordic Graphite	Nordic Graphite		990	 6 4 1 7 0 8 3 0 2 5 2 6 6

**Nordic Graphite** -värisävy saattaa vaihdella valmistuksessa käytettävän harjaustekniikan vuoksi.  
 Nyansen **Nordic Graphite** kan variera beroende på den borstningsteknik som används vid tillverkningen.  
 The **Nordic Graphite** shade may vary according to the brushing technique used in manufacturing.



**TURKKILEVYT**  
**DURKPLÅTAR**  
 TEAR SURFACES

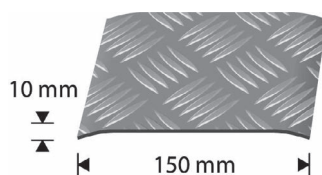

150 mm H=10 mm Turkkialumiini | Durkplåt maxi | Tear surface

TUOTENRO PRODUKTNR PRODUCT NO	VÄRI	FÄRG	COLOUR		PITUUS LÄNGD LENGTH	EAN-KOODI EAN-KOD EAN-CODE
SL9TLA1	Alumiini	Aluminium	Aluminium		1000	 6 4 17083 017872
SL9TLA2	Alumiini	Aluminium	Aluminium		2000	 6 4 17083 017889

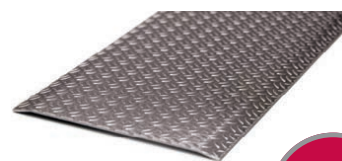
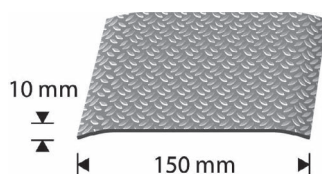

150 mm H=10 mm Jyvälumiini | Durkplåt mini | Grain surface

TUOTENRO PRODUKTNR PRODUCT NO	VÄRI	FÄRG	COLOUR		PITUUS LÄNGD LENGTH	EAN-KOODI EAN-KOD EAN-CODE
SL9JVA1	Alumiini	Aluminium	Aluminium		1000	 6 4 17083 017858
SL9JVA2	Alumiini	Aluminium	Aluminium		2000	 6 4 17083 017865

# FSC®-SERTIFIOIDUT TAMMIKYNNYKSET

## FSC®-CERTIFIERADE TRÖSKLAR I EK

### FSC® CERTIFIED OAK THRESHOLDS



The mark of responsible forestry

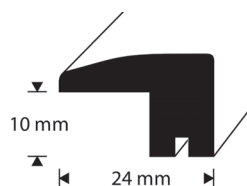

10 x 24 mm Kynnys/päätelista, lakattu tammi | Tröskel/avslutningslist, lackad ek  
Threshold/finishing profile, lacquered oak

TUOTENRO PRODUKTNR PRODUCT NO	VÄRI	FÄRG	COLOUR		PITUUS LÄNGD LENGTH	EAN-KOODI EAN-KOD EAN-CODE
WO7 OAK 1	Aito tammi	Äkta ek	Real oak		1000	 6 417083 112416
WO7 OAK 2	Aito tammi	Äkta ek	Real oak		2000	 6 417083 102424

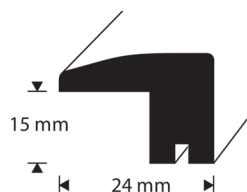

15 x 24 mm Kynnys/päätelista, lakattu tammi | Tröskel/avslutningslist, lackad ek  
Threshold/finishing profile, lacquered oak

TUOTENRO PRODUKTNR PRODUCT NO	VÄRI	FÄRG	COLOUR		PITUUS LÄNGD LENGTH	EAN-KOODI EAN-KOD EAN-CODE
WO8 OAK 1	Aito tammi	Äkta ek	Real oak		1000	 6 417083 152412
WO8 OAK 2	Aito tammi	Äkta ek	Real oak		2000	 6 417083 152429



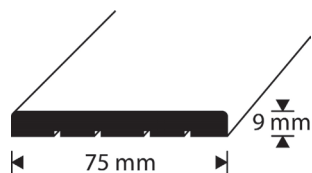



FSC®-SERTIFIOIDUT TAMMIKYNNYKSET  
FSC®-CERTIFIERADE TRÖSKLAR I EK  
FSC® CERTIFIED OAK THRESHOLDS



WO9 OAK



75 mm H=9 mm Kynnyslista, lakattu tammi | Tröskel, lackad ek | Threshold, lacquered oak

TUOTENRO PRODUKTNR PRODUCT NO	VÄRI	FÄRG	COLOUR		PITUUS LÄNGD LENGTH	EAN-KOODI EAN-KOD EAN-CODE
WO9 OAK 1	Aito tammi	Äkta ek	Real oak		1000	 6 4 17083 750915
WO9 OAK 2	Aito tammi	Äkta ek	Real oak		2000	 6 4 17083 750922
WO9 WO 2 ●	Valkotammi	Vit ek	White oak		2000	 6 4 17083 024399



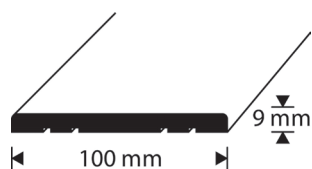



- **Poistuva tuote.** Kysy lisää myynnistä
- **Utgående produkt.** Fråga mer hos försäljningen
- **Discontinued product.** Contact sales for more information

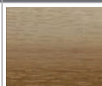

WO10 OAK

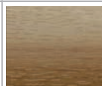

100 mm H=9 mm Kynnyslista, lakattu tammi | Tröskel, lackad ek | Threshold, lacquered oak

TUOTENRO PRODUKTNR PRODUCT NO	VÄRI	FÄRG	COLOUR		PITUUS LÄNGD LENGTH	EAN-KOODI EAN-KOD EAN-CODE
WO10 OAK 1	Aito tammi	Äkta ek	Real oak		1000	 6 4 17083 100918
WO10 OAK 2	Aito tammi	Äkta ek	Real oak		2000	 6 4 17083 100925
WO10 WO 2 ●	Valkotammi	Vit ek	White oak		2000	 6 4 17083 024375

- **Poistuva tuote.** Kysy lisää myynnistä
- **Utgående produkt.** Fråga mer hos försäljningen
- **Discontinued product.** Contact sales for more information

# FSC®-SERTIFIOIDUT TAMMIKYNNYKSET

FSC®-CERTIFIERADE TRÖSKLAR I EK

FSC® CERTIFIED OAK THRESHOLDS

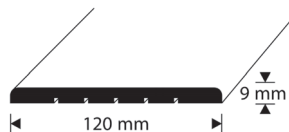

120 mm H=9 mm Kynnyslista, lakattu tammi | Tröskel, lackad ek | Threshold, lacquered oak

TUOTENRO PRODUKTNR PRODUCT NO	VÄRI	FÄRG	COLOUR		PITUUS LÄNGD LENGTH	EAN-KOODI EAN-KOD EAN-CODE
WO11 OAK 1	Aito tammi	Äkta ek	Real oak		1000	 6 417083 120916
WO11 OAK 2	Aito tammi	Äkta ek	Real oak		2000	 6 417083 120923



**POTKUPELLIT**  
**SPARKPLÅTAR**  
 KICK PLATES



Potkupelti, ruuvikiinnitys | Sparkplåt, skruvmontering | Kick plate, screw fastening

TUOTENRO PRODUKTNR PRODUCT NO	VÄRI	FÄRG	COLOUR		PITUUS LÄNGD LENGTH	EAN-KOODI EAN-KOD EAN-CODE
PP-9M	RST	Rostfritt stål	Stainless steel		780	 6 4 17083 024153
PP-10M	RST	Rostfritt stål	Stainless steel		880	 6 4 17083 023798

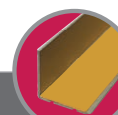

Potkupelti, teippikiinnitys | Sparkplåt , tejpmontering | Kick plate, tape fastening

TUOTENRO PRODUKTNR PRODUCT NO	VÄRI	FÄRG	COLOUR		PITUUS LÄNGD LENGTH	EAN-KOODI EAN-KOD EAN-CODE
PP-9MT	RST	Rostfritt stål	Stainless steel		780	 6 4 17083 023828
PP-10MT	RST	Rostfritt stål	Stainless steel		880	 6 4 17083 023804

# VIIMEISTELYLISTAT AVSLUTNINGSLISTER FINISHING TRIMS

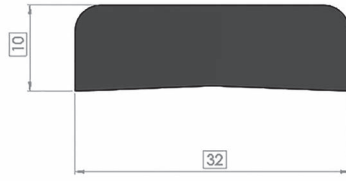

## 32 x 10 mm Peitelista | Täcklist | Cover profile

TUOTENRO PRODUKTNR PRODUCT NO	VÄRI	FÄRG	COLOUR		PITUUS LÄNGD LENGTH	EAN-KOODI EAN-KOD EAN-CODE
PL 32/10	Valkoinen	Vit	White		2500	 6 417083 024344









## 33 x 5 mm Peitelista | Täcklist | Cover profile

TUOTENRO PRODUKTNR PRODUCT NO	VÄRI	FÄRG	COLOUR		PITUUS LÄNGD LENGTH	EAN-KOODI EAN-KOD EAN-CODE
PL 33/5	Valkoinen	Vit	White		2500	 6 417083 034886



PL 42/10-470

## 42 x 10 mm Peitelista | Täcklist | Cover profile

TUOTENRO PRODUKTNR PRODUCT NO	VÄRI	FÄRG	COLOUR		PITUUS LÄNGD LENGTH	EAN-KOODI EAN-KOD EAN-CODE
PL 42/10	Valkoinen	Vit	White		2200	 6 417083 000423
PL 42/10-412	Vaaleanharmaa	Ljus grå	Light grey		2200	 6 417083 042461
PL 42/10-470	Musta	Svart	Black		2200	 6 417083 024771

**VIIMEISTELYLISTAT  
AVSLUTNINGSLISTER  
FINISHING TRIMS**



**58 x 10 mm Peitelista | Täcklist | Cover profile**

TUOTENRO PRODUKTNR PRODUCT NO	VÄRI	FÄRG	COLOUR		PITUUS LÄNGD LENGTH	EAN-KOODI EAN-KOD EAN-CODE
PL 58/10	Valkoinen	Vit	White		2500	 6 4 17083 02435 1



**70 x 12 mm Peitelista | Täcklist | Cover profile**

TUOTENRO PRODUKTNR PRODUCT NO	VÄRI	FÄRG	COLOUR		PITUUS LÄNGD LENGTH	EAN-KOODI EAN-KOD EAN-CODE
PL 70/12	Valkoinen	Vit	White		2200	 6 4 17083 04245 4

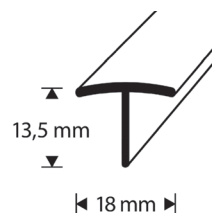

**18 mm T-lista | T-profil | T-profile**

TUOTENRO PRODUKTNR PRODUCT NO	VÄRI	FÄRG	COLOUR		PITUUS LÄNGD LENGTH	EAN-KOODI EAN-KOD EAN-CODE
T18-410	Valkoinen	Vit	White		2700	 6 4 17083 04251 5

# VIIMEISTELYLISTAT AVSLUTNINGSLISTER FINISHING TRIMS

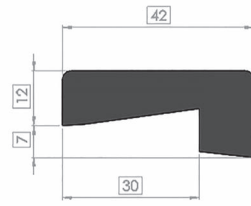

## 42 x 19 mm Reunalista | Kantlist | Edge moulding

TUOTENRO PRODUKTNR PRODUCT NO	VÄRI	FÄRG	COLOUR		PITUUS LÄNGD LENGTH	EAN-KOODI EAN-KOD EAN-CODE
VLS 7	Valkoinen	Vit	White		2200	 6 417083 025143

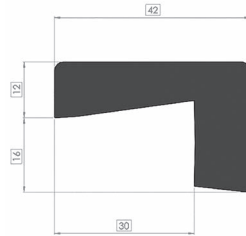

## 42 x 28 mm Reunalista | Kantlist | Edge moulding

TUOTENRO PRODUKTNR PRODUCT NO	VÄRI	FÄRG	COLOUR		PITUUS LÄNGD LENGTH	EAN-KOODI EAN-KOD EAN-CODE
VLS 16	Valkoinen	Vit	White		2200	 6 417083 025136

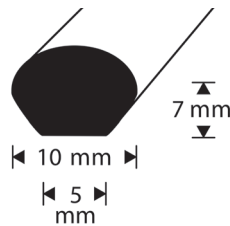

## 10 x 7 mm Viimeistelylista | Avslutningslist | Finishing trim

TUOTENRO PRODUKTNR PRODUCT NO	VÄRI	FÄRG	COLOUR		PITUUS LÄNGD LENGTH	EAN-KOODI EAN-KOD EAN-CODE
PY 10-410	Valkoinen	Vit	White		2500	 6 417083 020599

## VIIMEISTELYLISTAT AVSLUTNINGSLISTER FINISHING TRIMS

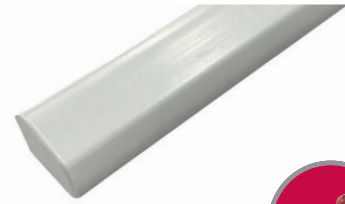
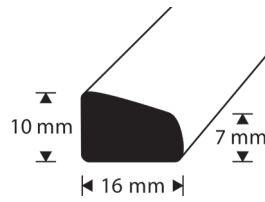

### 16 x 10 mm Viimeistelylista | Avslutningslist | Finishing trim

TUOTENRO PRODUKTNR PRODUCT NO	VÄRI	FÄRG	COLOUR		PITUUS LÄNGD LENGTH	EAN-KOODI EAN-KOD EAN-CODE
HL 1016-410	Valkoinen	Vit	White		2500	 6 4 17083 020612

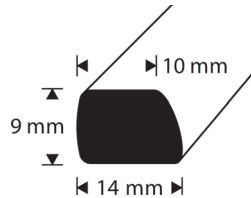

### 14 x 10 mm Lasilista | Glaslist | Glass profile

TUOTENRO PRODUKTNR PRODUCT NO	VÄRI	FÄRG	COLOUR		PITUUS LÄNGD LENGTH	EAN-KOODI EAN-KOD EAN-CODE
LL 14/10	Valkoinen	Vit	White		2000	 6 4 17083 000416

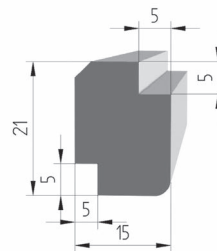

### 15 / 21 mm Varjolista | Skugglist | Shadow strip

TUOTENRO PRODUKTNR PRODUCT NO	VÄRI	FÄRG	COLOUR		PITUUS LÄNGD LENGTH	EAN-KOODI EAN-KOD EAN-CODE
VAR 15-410	Valkoinen	Vit	White		3000	 6 4 17083 042508

# IKKUNALAUDAT FÖNSTERBÄNKAR WINDOWSILLS

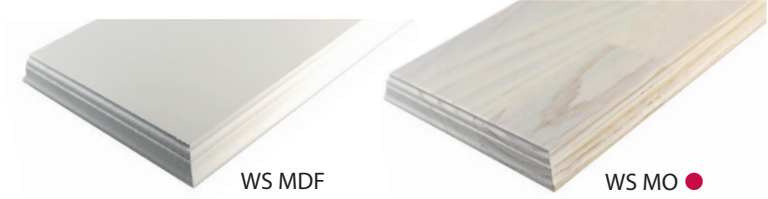
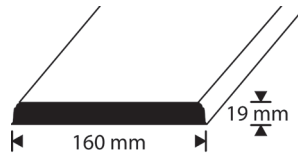

Ikkunalauta   Fönsterbänk   Windowsill						
TUOTENRO PRODUKTNR PRODUCT NO	VÄRI	FÄRG	COLOUR		PITUUS LÄNGD LENGTH	EAN-KOODI EAN-KOD EAN-CODE
WS100 MDF	Maalattu valkoinen	Vitmålad	Painted white		1000	6 417083 762321
WS100 MO ●	Valkotammi	Vit ek	White oak		1000	6 417083 659836
WS110 MDF	Maalattu valkoinen	Vitmålad	Painted white		1100	6 417083 762338
WS120 MDF	Maalattu valkoinen	Vitmålad	Painted white		1200	6 417083 762345
WS120 MO ●	Valkotammi	Vit ek	White oak		1200	6 417083 659843
WS130 MDF	Maalattu valkoinen	Vitmålad	Painted white		1300	6 417083 762352
WS140 MDF	Maalattu valkoinen	Vitmålad	Painted white		1400	6 417083 762369
WS140 MO ●	Valkotammi	Vit ek	White oak		1400	6 417083 659850
WS150 MDF	Maalattu valkoinen	Vitmålad	Painted white		1500	6 417083 762376
WS160 MDF	Maalattu valkoinen	Vitmålad	Painted white		1600	6 417083 659959
WS160 MO ●	Valkotammi	Vit ek	White oak		1600	6 417083 659867
WS180 MDF	Maalattu valkoinen	Vitmålad	Painted white		1800	6 417083 659966
WS180 MO ●	Valkotammi	Vit ek	White oak		1800	6 417083 659874

- **Poistuva tuote.** Kysy lisää myynnistä
- **Utgående produkt.** Fråga mer hos försäljningen
- **Discontinued product.** Contact sales for more information

# IKKUNALAUDAT FÖNSTERBÄNKAR WINDOWSILLS

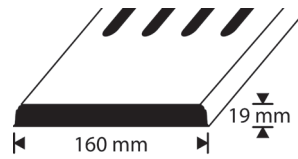

## Ikkunalauta, uritettu | Fönsterbänk, spårad | Windowsill, grooved

TUOTENRO PRODUKTNR PRODUCT NO	VÄRI	FÄRG	COLOUR		PITUUS LÄNGD LENGTH	EAN-KOODI EAN-KOD EAN-CODE
WSG100 MDF	Maalattu valkoinen	Vitmålad	Painted white		1000	 6 4 17083 762383
WSG110 MDF	Maalattu valkoinen	Vitmålad	Painted white		1100	 6 4 17083 762390
WSG120 MDF	Maalattu valkoinen	Vitmålad	Painted white		1200	 6 4 17083 762406
WSG130 MDF	Maalattu valkoinen	Vitmålad	Painted white		1300	 6 4 17083 762413
WSG140 MDF	Maalattu valkoinen	Vitmålad	Painted white		1400	 6 4 17083 762420
WSG150 MDF	Maalattu valkoinen	Vitmålad	Painted white		1500	 6 4 17083 762437
WSG160 MDF	Maalattu valkoinen	Vitmålad	Painted white		1600	 6 4 17083 659980
WSG180 MDF	Maalattu valkoinen	Vitmålad	Painted white		1800	 6 4 17083 659997



## Ikkunalaudan kannatin, puu | Fönsterbänk, trä | Windowsill, wood

TUOTENRO PRODUKTNR PRODUCT NO	VÄRI	FÄRG	COLOUR		KOKO STORLEK SIZE	EAN-KOODI EAN-KOD EAN-CODE
BRW150	Maalattu valkoinen	Vitmålad	Painted white		150 x 150	 6 4 17083 017261

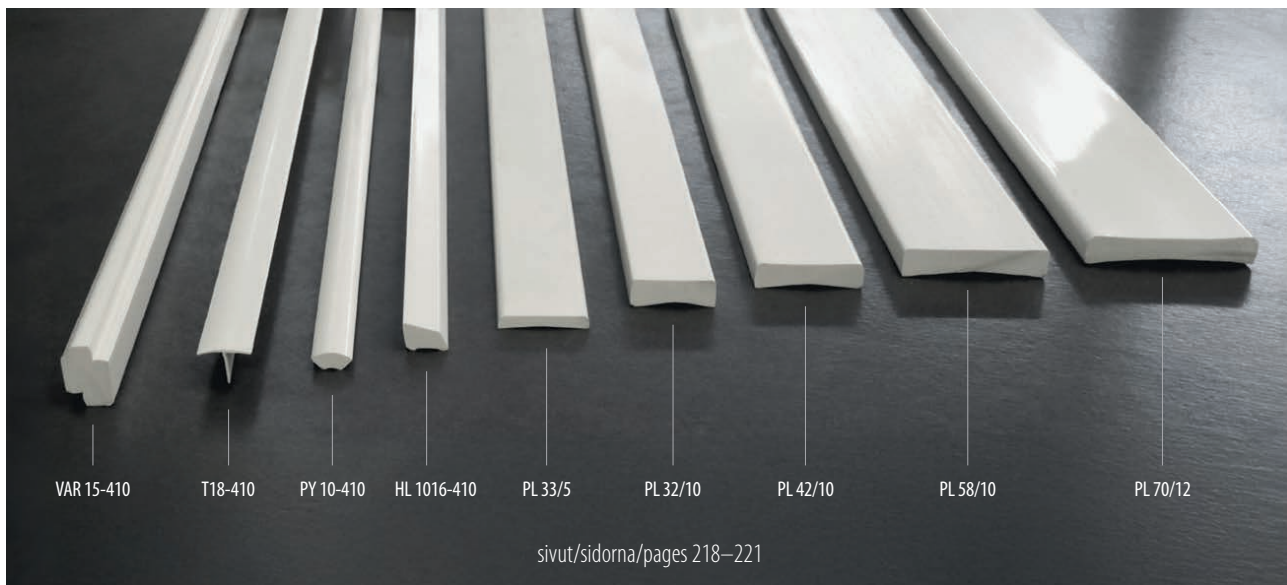

sivut/sidorna/pages 218–221

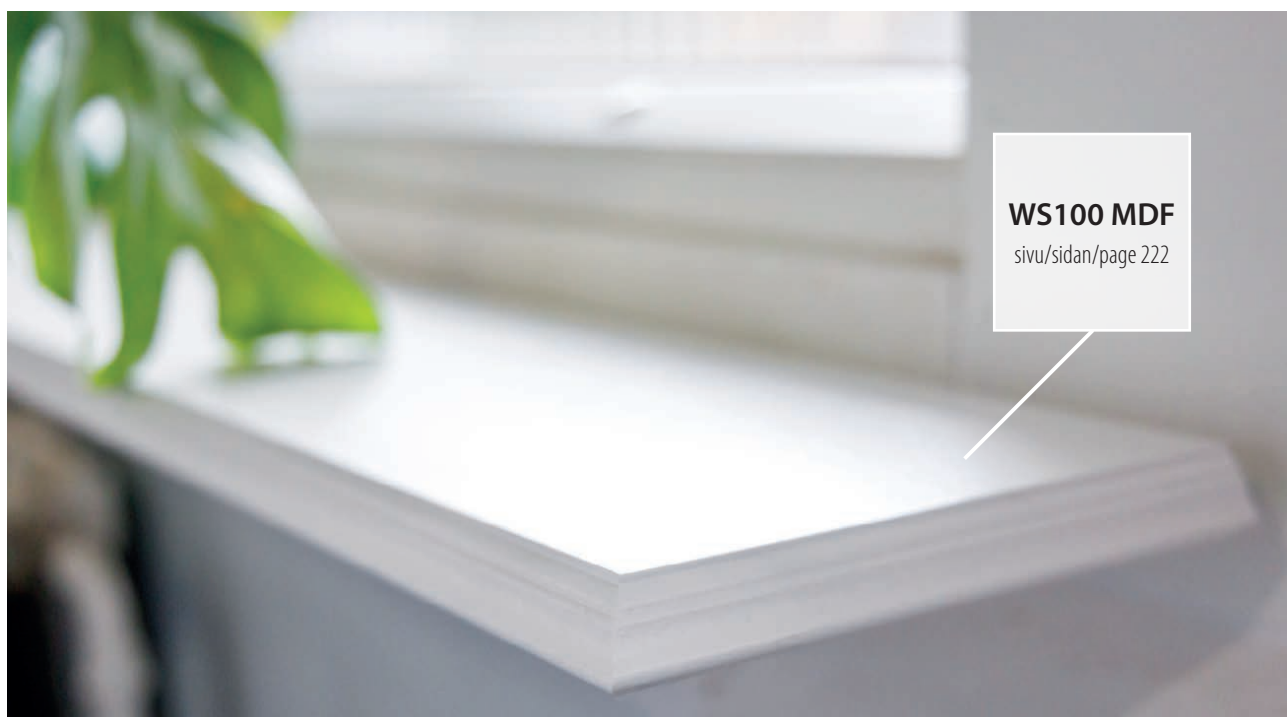

**WS100 MDF**  
sivu/sidan/page 222



# JOHTOKOTELOT KABELKANALER CABLE DUCTS

## **JÄRJESTÄ JA PIILOTA JOHDOT.**

Johtokoteloilla siivoat johdot kätevästi pois näkyviltä ja kokoat useamman johdon siististi yhteen.

## **ARRANGERA OCH DÖLJ KABLARNA.**

Med kabelkanaler kan du enkelt dölja kablar från insyn och samla flera kablar prydligt på ett ställe.

## **ORGANISE AND HIDE CABLES.**

Cable ducts make it easy to hide cables from view and neatly gather multiple cables together.

**JOHTOKOTELOT**  
**KABELKANALER**  
 CABLE DUCTS

**muoviset**  
 av plast  
 plastic

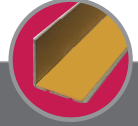
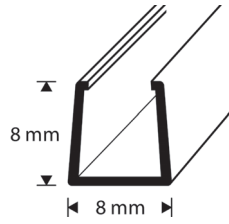

8 x 8 mm Johtokotelo | Kabelkanal | Cable duct

TUOTENRO PRODUKTNR PRODUCT NO	VÄRI	FÄRG	COLOUR		PITUUS LÄNGD LENGTH	EAN-KOODI EAN-KOD EAN-CODE
JK 88-410	Valkoinen	Vit	White		2500	 6 417083 880001

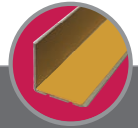
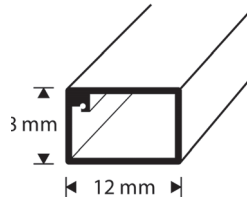

12 x 8 mm Johtokotelo | Kabelkanal | Cable duct

TUOTENRO PRODUKTNR PRODUCT NO	VÄRI	FÄRG	COLOUR		PITUUS LÄNGD LENGTH	EAN-KOODI EAN-KOD EAN-CODE
JK 128-410	Valkoinen	Vit	White		2500	 6 417083 128004

muoviset  
av plast  
plastic



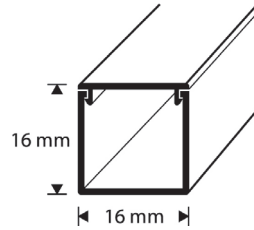

JOHTOKOTELOT  
KABELKANALER  
CABLE DUCTS

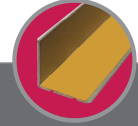

JK 1616-TA



16 x 16 mm Johtokotelo | Kabelkanal | Cable duct

TUOTENRO PRODUKTNR PRODUCT NO	VÄRI	FÄRG	COLOUR		PITUUS LÄNGD LENGTH	EAN-KOODI EAN-KOD EAN-CODE
JK 1616-410	Valkoinen	Vit	White		2500	 6 4 17083 16 1605
JK 1616-TA ●	Tammi	Ek	Oak		2500	 6 4 17083 16 1650

- **Poistuva tuote.** Kysy lisää myynnistä
- **Utgående produkt.** Fråga mer hos försäljningen
- **Discontinued product.** Contact sales for more information

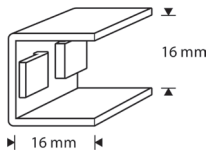

JK1616 Välikappale | Adapter stycke | Adapter piece

TUOTENRO PRODUKTNR PRODUCT NO	VÄRI	FÄRG	COLOUR	EAN-KOODI EAN-KOD EAN-CODE
JK 1616-CP	Valkoinen	Vit	White	 6 4 17083 16 1407

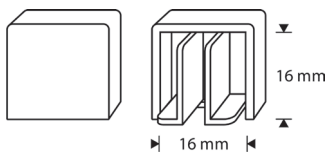

JK1616 Päätykappale | Ändstycke | End piece

TUOTENRO PRODUKTNR PRODUCT NO	VÄRI	FÄRG	COLOUR	EAN-KOODI EAN-KOD EAN-CODE
JK 1616-EC	Valkoinen	Vit	White	 6 4 17083 16 1506

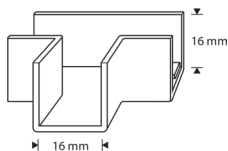

JK1616 T-kappale | T-stycke | T-piece



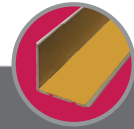
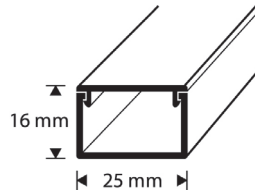

TUOTENRO PRODUKTNR PRODUCT NO	VÄRI	FÄRG	COLOUR	EAN-KOODI EAN-KOD EAN-CODE
JK 1616-FT	Valkoinen	Vit	White	 6 4 17083 16 2008

**JOHTOKOTELOT**  
**KABELKANALER**  
 CABLE DUCTS

**muoviset**  
 av plast  
 plastic



25 x 16 mm Johtokotelo | Kabelkanal | Cable duct

TUOTENRO PRODUKTNR PRODUCT NO	VÄRI	FÄRG	COLOUR		PITUUS LÄNGD LENGTH	EAN-KOODI EAN-KOD EAN-CODE
JK 2516-410	Valkoinen	Vit	White		2500	 6 417083 251603
JK 2516-TA ●	Tammi	Ek	Oak		2500	 6 417083 251658

- **Poistuva tuote.** Kysy lisää myynnistä
- **Utgående produkt.** Fråga mer hos försäljningen
- **Discontinued product.** Contact sales for more information

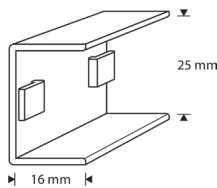

JK 2516 Välikappale | Adapter stycke | Adapter piece

TUOTENRO PRODUKTNR PRODUCT NO	VÄRI	FÄRG	COLOUR	EAN-KOODI EAN-KOD EAN-CODE
JK 2516-CP	Valkoinen	Vit	White	 6 417083 251405

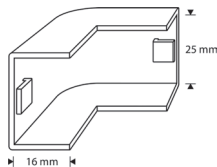

JK 2516 Ulkokulma | Hörnstycke | Outer corner

TUOTENRO PRODUKTNR PRODUCT NO	VÄRI	FÄRG	COLOUR	EAN-KOODI EAN-KOD EAN-CODE
JK 2516-EA	Valkoinen	Vit	White	 6 417083 251801

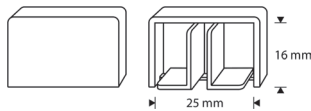

JK 2516 Päätykappale | Ändstycke | End piece

TUOTENRO PRODUKTNR PRODUCT NO	VÄRI	FÄRG	COLOUR	EAN-KOODI EAN-KOD EAN-CODE
JK 2516-EC	Valkoinen	Vit	White	 6 417083 251504

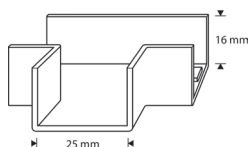

JK 2516 T-kappale | T-stycke | T-piece

TUOTENRO PRODUKTNR PRODUCT NO	VÄRI	FÄRG	COLOUR	EAN-KOODI EAN-KOD EAN-CODE
JK 2516-FT	Valkoinen	Vit	White	 6 417083 252006

**muoviset**  
av plast  
plastic

**JOHTOKOTELOT**  
KABELKANALER  
CABLE DUCTS

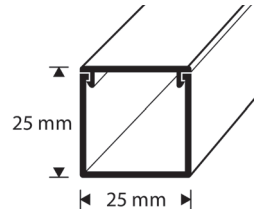



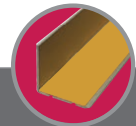
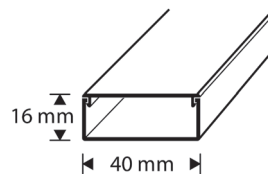

25 x 25 mm Johtokotelo | Kabelkanal | Cable duct

TUOTENRO PRODUKTNR PRODUCT NO	VÄRI	FÄRG	COLOUR		PITUUS LÄNGD LENGTH	EAN-KOODI EAN-KOD EAN-CODE
JK 2525-410	Valkoinen	Vit	White		2500	 6 4 17083 252501



40 x 16 mm Johtokotelo | Kabelkanal | Cable duct

TUOTENRO PRODUKTNR PRODUCT NO	VÄRI	FÄRG	COLOUR		PITUUS LÄNGD LENGTH	EAN-KOODI EAN-KOD EAN-CODE
JK 4016-410	Valkoinen	Vit	White		2500	 6 4 17083 401602
JK 4016-TA ●	Tammi	Ek	Oak		2500	 6 4 17083 401657

- **Poistuva tuote.** Kysy lisää myynnistä
- **Utgående produkt.** Fråga mer hos försäljningen
- **Discontinued product.** Contact sales for more information

**JOHTOKOTELOT**  
**KABELKANALER**  
**CABLE DUCTS**

**muovi / metalli**  
**av plast / metall**  
**plastic / metal**

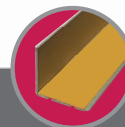
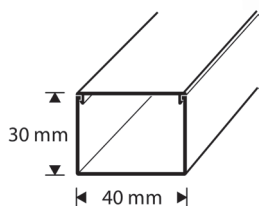

40 x 30 mm Johtokotelo | Kabelkanal | Cable duct

TUOTENRO PRODUKTNR PRODUCT NO	VÄRI	FÄRG	COLOUR		PITUUS LÄNGD LENGTH	EAN-KOODI EAN-KOD EAN-CODE
JK 4030-410	Valkoinen	Vit	White		2500	 6 417083 403002

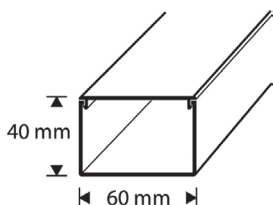

60 x 40 mm Johtokotelo | Kabelkanal | Cable duct

TUOTENRO PRODUKTNR PRODUCT NO	VÄRI	FÄRG	COLOUR		PITUUS LÄNGD LENGTH	EAN-KOODI EAN-KOD EAN-CODE
JK 6040-410	Valkoinen	Vit	White		2500	 6 417083 604003

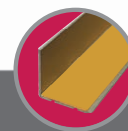
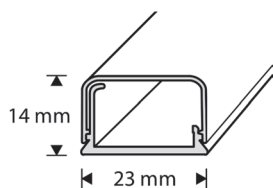

23 x 14 mm Johtokotelo, alumiini | Kabelkanal, aluminium | Cable duct, aluminium

TUOTENRO PRODUKTNR PRODUCT NO	VÄRI	FÄRG	COLOUR		PITUUS LÄNGD LENGTH	EAN-KOODI EAN-KOD EAN-CODE
CD 2314-AS	RST-anodisoitu	Rostfritt stål anodiserad	Stainless steel anodized		2500	 6 417083 132506

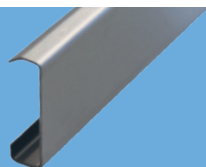

Katso myös RST-johtojalkalistat sivu 134

Se också Golvsocklar med kabelkanal av rostfritt stål sidan 134

See also Stainless steel skirtings with cable duct page 134



# HOBBY-TUOTTEET HOBBY-PRODUKTER HOBBY PRODUCTS

## **SUUNNITTELE JA LUO AINUTLAATUISIA RATKAISUJA HOBBY-TUOTTEILLA.**

Dione Hobby -listat, putket ja palkit soveltuvat moniin eri käyttötarkoituksiin, kuten akvaarioihin, säilytys- ja kuljetuslaatikoihin, liukuovikaappeihin, valokuva- ja peilikehyksiin sekä säleikköihin. Erityisesti J-listat soveltuvat loistavasti peileihin.

Dione MEKANO -teräsputkista ja liitososista syntyy uniikkeja putkikalusteita (s. 255).

## **PLANERA OCH SKAPA UNIKA LÖSNINGAR MED VÅRA HOBBY-PRODUKTER.**

Dione Hobby-lister, rör och balkar passar för en mängd användningsområden som akvarium, förvarings- och transportlådor, skjutdörrskåp, foto- och spegelramar samt galler. I synnerhet J-listerna passar perfekt för speglar.

Av Dione MEKANO stålrör och kopplingsdelar skapas unika möbler (s. 255).

## **DESIGN AND CREATE UNIQUE SOLUTIONS WITH HOBBY PRODUCTS.**







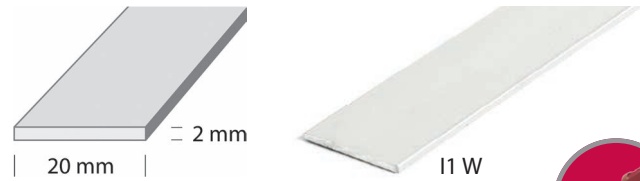









Dione Hobby profiles, tubes and bars can be used for a multitude of projects such as aquariums, storage and transport cases, sliding door cabinets, picture and mirror frames and gratings. J-profiles in particular are perfect for mirrors.

Dione MEKANO steel tubes and various clamps make it possible to create unique pipe furniture (p. 255).

**HOBBY-TUOTTEET**  
**HOBBY-PRODUKTER**  
**HOBBY PRODUCTS**







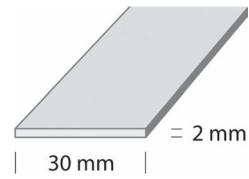











20 x 2 mm Lattalista | I-profil | Flat bar

TUOTENRO PRODUKTNR PRODUCT NO	VÄRI	FÄRG	COLOUR		PITUUS LÄNGD LENGTH	EAN-KOODI EAN-KOD EAN-CODE
I1 CBL1	Carbon black	Carbon black	Carbon black		1000	 6 417083 039584
I1 CBL2	Carbon black	Carbon black	Carbon black		2000	 6 417083 039591
I1 CBL3	Carbon black	Carbon black	Carbon black		3000	 6 417083 039607
I1 HE1	Hopea-anodisoitu	Silver anodiserad	Silver anodized		1000	 6 417083 121609
I1 HE2	Hopea-anodisoitu	Silver anodiserad	Silver anodized		2000	 6 417083 221606
I1 HE3	Hopea-anodisoitu	Silver anodiserad	Silver anodized		3000	 6 417083 040276
I1 W1	Maalattu valkoinen	Vitmålad	Painted white		1000	 6 417083 191602
I1 W2	Maalattu valkoinen	Vitmålad	Painted white		2000	 6 417083 291609



















30 x 2 mm Lattalista | I-profil | Flat bar

TUOTENRO PRODUKTNR PRODUCT NO	VÄRI	FÄRG	COLOUR		PITUUS LÄNGD LENGTH	EAN-KOODI EAN-KOD EAN-CODE
I2 CBL1	Carbon black	Carbon black	Carbon black		1000	 6 4 17083 039751
I2 CBL2	Carbon black	Carbon black	Carbon black		2000	 6 4 17083 039737
I2 CBL3	Carbon black	Carbon black	Carbon black		3000	 6 4 17083 038822
I2 HE1	Hopea-anodisoitu	Silver anodiserad	Silver anodized		1000	 6 4 17083 122606
I2 HE2	Hopea-anodisoitu	Silver anodiserad	Silver anodized		2000	 6 4 17083 222603
I2 HE3	Hopea-anodisoitu	Silver anodiserad	Silver anodized		3000	 6 4 17083 038839
I2 W1	Maalattu valkoinen	Vitmålad	Painted white		1000	 6 4 17083 192609
I2 W2	Maalattu valkoinen	Vitmålad	Painted white		2000	 6 4 17083 292606

**HOBBY-TUOTTEET**  
**HOBBY-PRODUKTER**  
**HOBBY PRODUCTS**







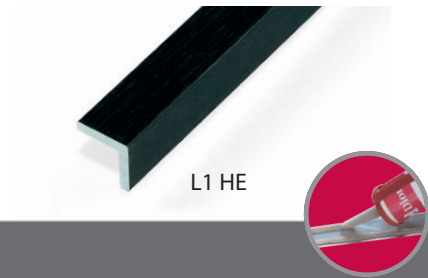
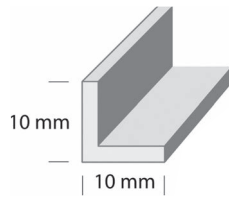













40 x 2 mm Lattalista | I-profil | Flat bar

TUOTENRO PRODUKTNR PRODUCT NO	VÄRI	FÄRG	COLOUR		PITUUS LÄNGD LENGTH	EAN-KOODI EAN-KOD EAN-CODE
I3 CBL1	Carbon black	Carbon black	Carbon black		1000	 6 4 1 7 0 8 3 0 3 8 8 6 0
I3 CBL2	Carbon black	Carbon black	Carbon black		2000	 6 4 1 7 0 8 3 0 3 8 8 7 7
I3 CBL3	Carbon black	Carbon black	Carbon black		3000	 6 4 1 7 0 8 3 0 3 8 8 8 4
I3 HE1	Hopea-anodisoitu	Silver anodiserad	Silver anodized		1000	 6 4 1 7 0 8 3 1 2 3 6 0 3
I3 HE2	Hopea-anodisoitu	Silver anodiserad	Silver anodized		2000	 6 4 1 7 0 8 3 2 2 3 6 0 0
I3 HE3	Hopea-anodisoitu	Silver anodiserad	Silver anodized		3000	 6 4 1 7 0 8 3 0 3 8 8 9 1
I3 W1	Maalattu valkoinen	Vitmålad	Painted white		1000	 6 4 1 7 0 8 3 1 9 3 6 0 6
I3 W2	Maalattu valkoinen	Vitmålad	Painted white		2000	 6 4 1 7 0 8 3 2 9 3 6 0 3



15 x 10 mm Kulmalista | Hörnlist | Corner trim

TUOTENRO PRODUKTNR PRODUCT NO	VÄRI	FÄRG	COLOUR		PITUUS LÄNGD LENGTH	EAN-KOODI EAN-KOD EAN-CODE
L10 CBL1	Carbon black	Carbon black	Carbon black		1000	 6 4 17083 039188
L10 CBL2	Carbon black	Carbon black	Carbon black		2000	 6 4 17083 039195
L10 CBL3	Carbon black	Carbon black	Carbon black		3000	 6 4 17083 039201
L10 HE1	Hopea-anodisoitu	Silver anodiserad	Silver anodized		1000	 6 4 17083 039218
L10 HE2	Hopea-anodisoitu	Silver anodiserad	Silver anodized		2000	 6 4 17083 039225
L10 HE3	Hopea-anodisoitu	Silver anodiserad	Silver anodized		3000	 6 4 17083 039232
L10 W1	Maalattu valkoinen	Vitmålad	Painted white		1000	 6 4 17083 039249
L10 W2	Maalattu valkoinen	Vitmålad	Painted white		2000	 6 4 17083 039256
L10 W3	Maalattu valkoinen	Vitmålad	Painted white		3000	 6 4 17083 039263

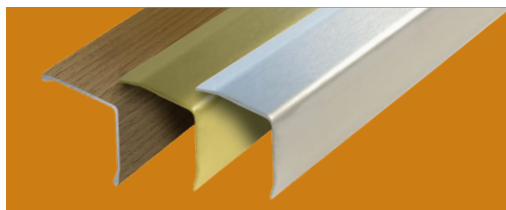





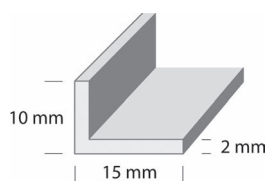













Katso myös Kulmasuojalistat sivu 148  
Se också Hörnskyddsprofiler sidan 148  
See also Corner Protection page 148

**HOBBY-TUOTTEET**  
**HOBBY-PRODUKTER**  
**HOBBY PRODUCTS**







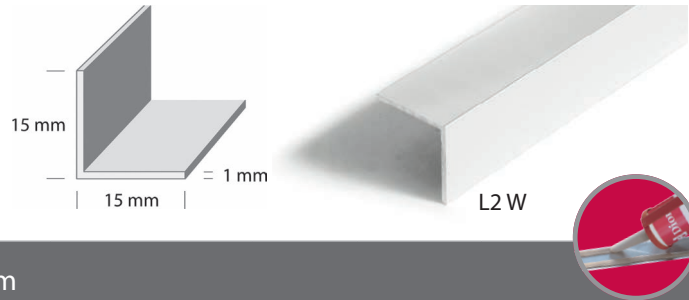









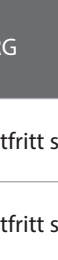

15 x 10 mm Kulmalista | Hörnlist | Corner trim

TUOTENRO PRODUKTNR PRODUCT NO	VÄRI	FÄRG	COLOUR		PITUUS LÄNGD LENGTH	EAN-KOODI EAN-KOD EAN-CODE
L1 CBL1	Carbon black	Carbon black	Carbon black		1000	 6 417 083 039 157
L1 CBL2	Carbon black	Carbon black	Carbon black		2000	 6 417 083 039 164
L1 CBL3	Carbon black	Carbon black	Carbon black		3000	 6 417 083 039 171
L1 HE1	Hopea-anodisoitu	Silver anodiserad	Silver anodized		1000	 6 417 083 121 005
L1 HE2	Hopea-anodisoitu	Silver anodiserad	Silver anodized		2000	 6 417 083 221 002
L1 HE3	Hopea-anodisoitu	Silver anodiserad	Silver anodized		3000	 6 417 083 321 009
L1 W1	Maalattu valkoinen	Vitmålad	Painted white		1000	 6 417 083 191 008
L1 W2	Maalattu valkoinen	Vitmålad	Painted white		2000	 6 417 083 291 005
L1 W3	Maalattu valkoinen	Vitmålad	Painted white		3000	 6 417 083 391 002



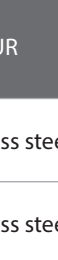



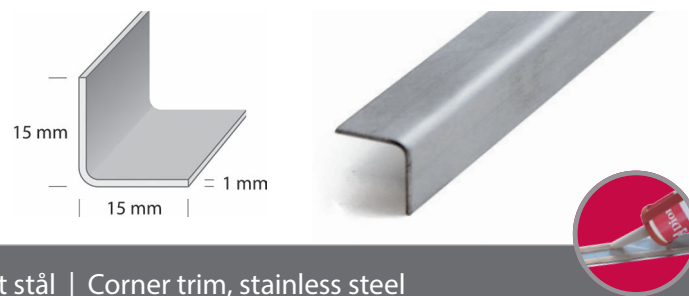

15 x 10 mm Kulmalista | Hörnlist | Corner trim

TUOTENRO PRODUKTNR PRODUCT NO	VÄRI	FÄRG	COLOUR		PITUUS LÄNGD LENGTH	EAN-KOODI EAN-KOD EAN-CODE
L2 CBL1	Carbon black	Carbon black	Carbon black		1000	
L2 CBL2	Carbon black	Carbon black	Carbon black		2000	
L2 CBL3	Carbon black	Carbon black	Carbon black		3000	
L2 HE1	Hopea-anodisoitu	Silver anodiserad	Silver anodized		1000	
L2 HE2	Hopea-anodisoitu	Silver anodiserad	Silver anodized		2000	
L2 HE3	Hopea-anodisoitu	Silver anodiserad	Silver anodized		3000	
L2 W1	Maalattu valkoinen	Vitmålad	Painted white		1000	
L2 W2	Maalattu valkoinen	Vitmålad	Painted white		2000	
L2 W3	Maalattu valkoinen	Vitmålad	Painted white		3000	



15 x 15 mm Kulmalista, RST | Hörnlist, rostfritt stål | Corner trim, stainless steel

TUOTENRO PRODUKTNR PRODUCT NO	VÄRI	FÄRG	COLOUR		PITUUS LÄNGD LENGTH	EAN-KOODI EAN-KOD EAN-CODE
L2 RST1	RST	Rostfritt stål	Stainless steel		1000	
L2 RST2	RST	Rostfritt stål	Stainless steel		2000	
L2 RST3	RST	Rostfritt stål	Stainless steel		3000	

**HOBBY-TUOTTEET**  
**HOBBY-PRODUKTER**  
**HOBBY PRODUCTS**

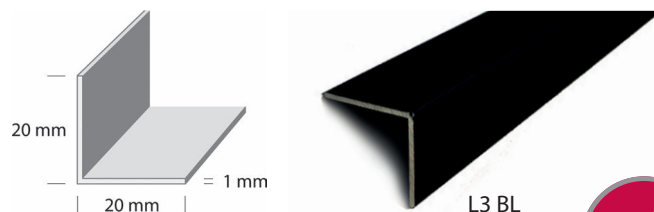



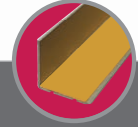
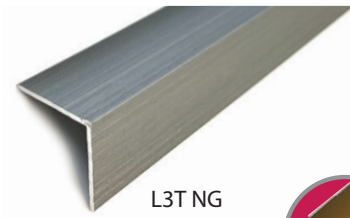
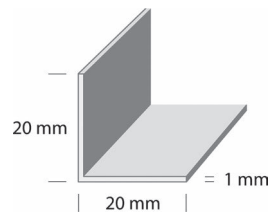

20 x 20 mm Kulmalista | Hörnlist | Corner trim

TUOTENRO PRODUKTNR PRODUCT NO	VÄRI	FÄRG	COLOUR		PITUUS LÄNGD LENGTH	EAN-KOODI EAN-KOD EAN-CODE
L3 CBL1	Carbon black	Carbon black	Carbon black		1000	 6 417 083 039317
L3 CBL2	Carbon black	Carbon black	Carbon black		2000	 6 417 083 039324
L3 CBL3	Carbon black	Carbon black	Carbon black		3000	 6 417 083 039331
L3 BL1	Maalattu musta	Svart målad	Painted black		1000	 6 417 083 023019
L3 BL2	Maalattu musta	Svart målad	Painted black		2000	 6 417 083 023026
L3 HE1	Hopea-anodisoitu	Silver anodiserad	Silver anodized		1000	 6 417 083 123009
L3 HE2	Hopea-anodisoitu	Silver anodiserad	Silver anodized		2000	 6 417 083 223006
L3 HE3	Hopea-anodisoitu	Silver anodiserad	Silver anodized		3000	 6 417 083 323003
L3 NG1	Nordic Graphite	Nordic Graphite	Nordic Graphite		1000	 6 417 083 023040
L3 NG2	Nordic Graphite	Nordic Graphite	Nordic Graphite		2000	 6 417 083 023057
L3 W1	Maalattu valkoinen	Vitmålad	Painted white		1000	 6 417 083 193002
L3 W2	Maalattu valkoinen	Vitmålad	Painted white		2000	 6 417 083 293009
L3 W3	Maalattu valkoinen	Vitmålad	Painted white		3000	 6 417 083 393006

**Nordic Graphite** -värisävy saattaa vaihdella valmistuksessa käytettävän harjaustekniikan vuoksi. Nyanssen **Nordic Graphite** kan variera beroende på den borstningsteknik som används vid tillverkningen. The **Nordic Graphite** shade may vary according to the brushing technique used in manufacturing.



20 x 20 mm Tarrakulmalista | Hörnlist, tejpmontering | Corner trim, tape fastening

TUOTENRO PRODUKTNR PRODUCT NO	VÄRI	FÄRG	COLOUR		PITUUS LÄNGD LENGTH	EAN-KOODI EAN-KOD EAN-CODE
L3T CBL3	Carbon black	Carbon black	Carbon black		3000	 6 4 17083 040245
L3T NG3	Nordic Graphite	Nordic Graphite	Nordic Graphite		3000	 6 4 17083 023035

 **Nordic Graphite** -värisävy saattaa vaihdella valmistuksessa käytettävän harjaustekniikan vuoksi.  
Nyansen **Nordic Graphite** kan variera beroende på den borstringsteknik som används vid tillverkningen.  
The **Nordic Graphite** shade may vary according to the brushing technique used in manufacturing.

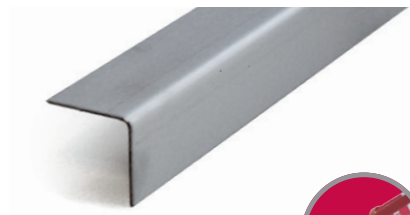
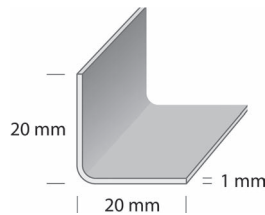

20 x 20 mm Kulmalista, RST | Hörnlist, rostfritt stål | Corner trim, stainless steel

TUOTENRO PRODUKTNR PRODUCT NO	VÄRI	FÄRG	COLOUR		PITUUS LÄNGD LENGTH	EAN-KOODI EAN-KOD EAN-CODE
L3 RST1	RST	Rostfritt stål	Stainless steel		1000	 6 4 17083 018343
L3 RST2	RST	Rostfritt stål	Stainless steel		2000	 6 4 17083 018350
L3 RST3	RST	Rostfritt stål	Stainless steel		3000	 6 4 17083 018367

**HOBBY-TUOTTEET**  
**HOBBY-PRODUKTER**  
**HOBBY PRODUCTS**

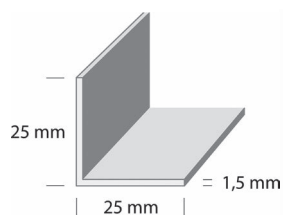

L4 HE



25 x 25 mm Kulmalista | Hörnlist | Corner trim

TUOTENRO PRODUKTNR PRODUCT NO	VÄRI	FÄRG	COLOUR		PITUUS LÄNGD LENGTH	EAN-KOODI EAN-KOD EAN-CODE
L4 CBL1	Carbon black	Carbon black	Carbon black		1000	 6 417 083 023071
L4 CBL2	Carbon black	Carbon black	Carbon black		2000	 6 417 083 023088
L4 CBL3	Carbon black	Carbon black	Carbon black		3000	 6 417 083 124006
L4 BL1	Maalattu musta	Svart målad	Painted black		1000	 6 417 083 224003
L4 BL2	Maalattu musta	Svart målad	Painted black		2000	 6 417 083 324000
L4 HE1	Hopea-anodisoitu	Silver anodiserad	Silver anodized		1000	 6 417 083 023101
L4 HE2	Hopea-anodisoitu	Silver anodiserad	Silver anodized		2000	 6 417 083 023118
L4 HE3	Hopea-anodisoitu	Silver anodiserad	Silver anodized		3000	 6 417 083 194009
L4 NG1	Nordic Graphite	Nordic Graphite	Nordic Graphite		1000	 6 417 083 294006
L4 NG2	Nordic Graphite	Nordic Graphite	Nordic Graphite		2000	 6 417 083 394003
L4 W1	Maalattu valkoinen	Vitmålad	Painted white		1000	 6 417 083 194009
L4 W2	Maalattu valkoinen	Vitmålad	Painted white		2000	 6 417 083 294006
L4 W3	Maalattu valkoinen	Vitmålad	Painted white		3000	 6 417 083 394003

**Nordic Graphite** -värisävy saattaa vaihdella valmistuksessa käytettävän harjaustekniikan vuoksi. Nyanssen **Nordic Graphite** kan variera beroende på den borstningsteknik som används vid tillverkningen. The **Nordic Graphite** shade may vary according to the brushing technique used in manufacturing.

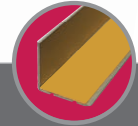
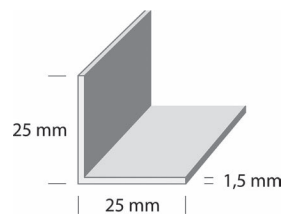

25 x 25 mm Tarrakulmalista | Hörnlist, tejpmontering | Corner trim, tape fastening

TUOTENRO PRODUKTNR PRODUCT NO	VÄRI	FÄRG	COLOUR		PITUUS LÄNGD LENGTH	EAN-KOODI EAN-KOD EAN-CODE
L4T BL3	Maalattu musta	Svart målad	Painted black		3000	 6 4 17083 023064
L4T CBL3	Carbon black	Carbon black	Carbon black		3000	 6 4 17083 040252
L4T NG3	Nordic Graphite	Nordic Graphite	Nordic Graphite		3000	 6 4 17083 023095

 **Nordic Graphite** -värisävy saattaa vaihdella valmistuksessa käytettävän harjaustekniikan vuoksi.  
Nyansen **Nordic Graphite** kan variera beroende på den borstningsteknik som används vid tillverkningen.  
The **Nordic Graphite** shade may vary according to the brushing technique used in manufacturing.

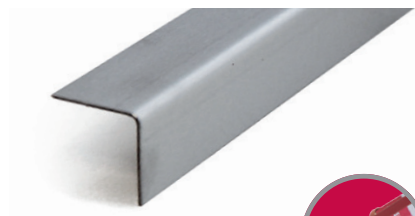
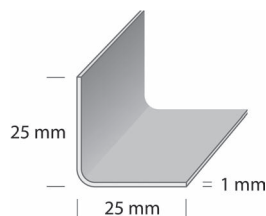

25 x 25 mm Kulmalista, RST | Hörnlist, rostfritt stål | Corner trim, stainless steel

TUOTENRO PRODUKTNR PRODUCT NO	VÄRI	FÄRG	COLOUR		PITUUS LÄNGD LENGTH	EAN-KOODI EAN-KOD EAN-CODE
L4 RST1	RST	Rostfritt stål	Stainless steel		1000	 6 4 17083 018374
L4 RST2	RST	Rostfritt stål	Stainless steel		2000	 6 4 17083 018381
L4 RST3	RST	Rostfritt stål	Stainless steel		3000	 6 4 17083 018398



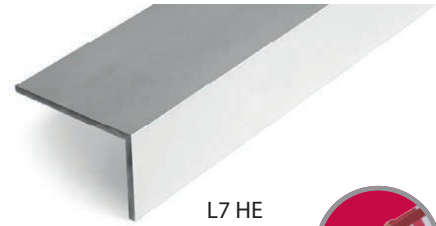
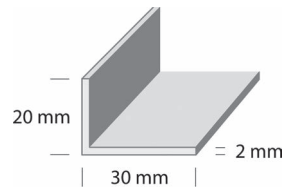









**HOBBY-TUOTTEET**  
**HOBBY-PRODUKTER**  
**HOBBY PRODUCTS**



L7 HE



30 x 20 mm Kulmalista | Hörnlist | Corner trim

TUOTENRO PRODUKTNR PRODUCT NO	VÄRI	FÄRG	COLOUR		PITUUS LÄNGD LENGTH	EAN-KOODI EAN-KOD EAN-CODE
L7 HE1	Hopea-anodisoitu	Silver anodiserad	Silver anodized		1000	 6 417 083 949 524
L7 HE2	Hopea-anodisoitu	Silver anodiserad	Silver anodized		2000	 6 417 083 949 531
L7 HE3	Hopea-anodisoitu	Silver anodiserad	Silver anodized		3000	 6 417 083 949 548
L7 W1	Maalattu valkoinen	Vitmålad	Painted white		1000	 6 417 083 949 555
L7 W2	Maalattu valkoinen	Vitmålad	Painted white		2000	 6 417 083 949 562
L7 W3	Maalattu valkoinen	Vitmålad	Painted white		3000	 6 417 083 949 579

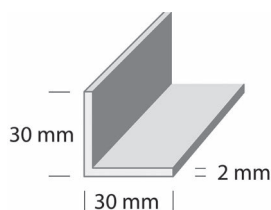

30 x 30 mm Kulmalista | Hörnlist | Corner trim



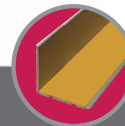
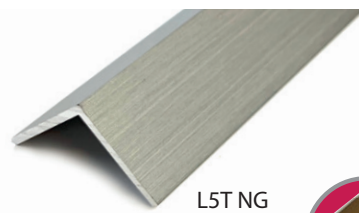
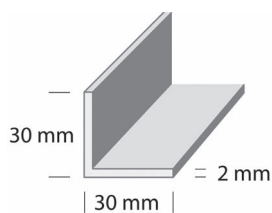

TUOTENRO PRODUKTNR PRODUCT NO	VÄRI	FÄRG	COLOUR		PITUUS LÄNGD LENGTH	EAN-KOODI EAN-KOD EAN-CODE
L5 CBL1	Carbon black	Carbon black	Carbon black		1000	 6 4 17083 039379
L5 CBL2	Carbon black	Carbon black	Carbon black		2000	 6 4 17083 039386
L5 CBL3	Maalattu musta	Svart målad	Painted black		3000	 6 4 17083 039393
L5 BL1	Maalattu musta	Svart målad	Painted black		1000	 6 4 17083 023132
L5 BL2	Maalattu musta	Svart målad	Painted black		2000	 6 4 17083 023149
L5 HE1	Hopea-anodisoitu	Silver anodiserad	Silver anodized		1000	 6 4 17083 125003
L5 HE2	Hopea-anodisoitu	Silver anodiserad	Silver anodized		2000	 6 4 17083 225000
L5 HE3	Hopea-anodisoitu	Silver anodiserad	Silver anodized		3000	 6 4 17083 325007
L5 NG1	Nordic graphite	Nordic graphite	Nordic graphite		1000	 6 4 17083 023163
L5 NG2	Nordic graphite	Nordic graphite	Nordic graphite		2000	 6 4 17083 023170
L5 W1	Maalattu valkoinen	Vitmålad	Painted white		1000	 6 4 17083 195006
L5 W2	Maalattu valkoinen	Vitmålad	Painted white		2000	 6 4 17083 295003
L5 W3	Maalattu valkoinen	Vitmålad	Painted white		3000	 6 4 17083 395000

**Nordic Graphite** -värisävy saattaa vaihdella valmistuksessa käytettävän harjaustekniikan vuoksi. Nyansen **Nordic Graphite** kan variera beroende på den borstningsteknik som används vid tillverkningen. The **Nordic Graphite** shade may vary according to the brushing technique used in manufacturing.

**HOBBY-TUOTTEET**  
**HOBBY-PRODUKTER**  
**HOBBY PRODUCTS**





30 x 30 mm Tarrakulmalista | Hörnlist, tejpmontering | Corner trim, tape fastening

TUOTENRO PRODUKTNR PRODUCT NO	VÄRI	FÄRG	COLOUR		PITUUS LÄNGD LENGTH	EAN-KOODI EAN-KOD EAN-CODE
L5T CBL3	Carbon black	Carbon black	Carbon black		3000	 6 417083 040269
L5T NG3	Nordic Graphite	Nordic Graphite	Nordic Graphite		3000	 6 417083 023156

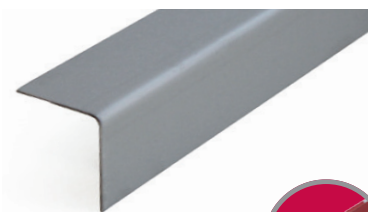
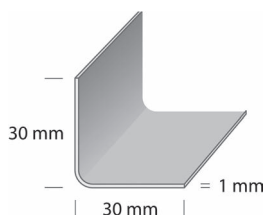
 **Nordic Graphite** -värisävy saattaa vaihdella valmistuksessa käytettävän harjaustekniikan vuoksi. Nyansen **Nordic Graphite** kan variera beroende på den borstningsteknik som används vid tillverkningen. The **Nordic Graphite** shade may vary according to the brushing technique used in manufacturing.



30 x 30 mm Kulmalista, RST | Hörnlist, rostfritt stål | Corner trim, stainless steel

TUOTENRO PRODUKTNR PRODUCT NO	VÄRI	FÄRG	COLOUR		PITUUS LÄNGD LENGTH	EAN-KOODI EAN-KOD EAN-CODE
L5 RST1	RST	Rostfritt stål	Stainless steel		1000	 6 417083 018404
L5 RST2	RST	Rostfritt stål	Stainless steel		2000	 6 417083 018411
L5 RST3	RST	Rostfritt stål	Stainless steel		3000	 6 417083 018428

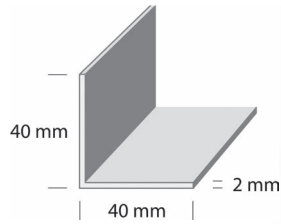

L6 HE



40 x 40 mm Kulmalista | Hörnlist | Corner trim

TUOTENRO PRODUKTNR PRODUCT NO	VÄRI	FÄRG	COLOUR		PITUUS LÄNGD LENGTH	EAN-KOODI EAN-KOD EAN-CODE
L6 HE1	Hopea-anodisoitu	Silver anodiserad	Silver anodized		1000	 6 4 17083 126000
L6 HE2	Hopea-anodisoitu	Silver anodiserad	Silver anodized		2000	 6 4 17083 226007
L6 HE3	Hopea-anodisoitu	Silver anodiserad	Silver anodized		3000	 6 4 17083 326004
L6 W1	Maalattu valkoinen	Vitmålad	Painted white		1000	 6 4 17083 196003
L6 W2	Maalattu valkoinen	Vitmålad	Painted white		2000	 6 4 17083 296000
L6 W3	Maalattu valkoinen	Vitmålad	Painted white		3000	 6 4 17083 396007

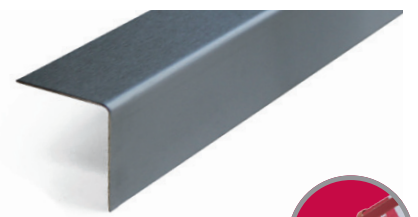
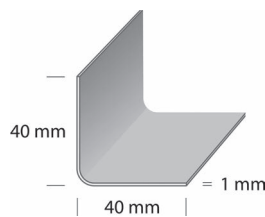

40 x 40 mm Kulmalista, RST | Hörnlist, rostfritt stål | Corner trim, stainless steel

TUOTENRO PRODUKTNR PRODUCT NO	VÄRI	FÄRG	COLOUR		PITUUS LÄNGD LENGTH	EAN-KOODI EAN-KOD EAN-CODE
L6 RST1	RST	Rostfritt stål	Stainless steel		1000	 6 4 17083 018435
L6 RST2	RST	Rostfritt stål	Stainless steel		2000	 6 4 17083 018442
L6 RST3	RST	Rostfritt stål	Stainless steel		3000	 6 4 17083 018459

**HOBBY-TUOTTEET**  
**HOBBY-PRODUKTER**  
**HOBBY PRODUCTS**

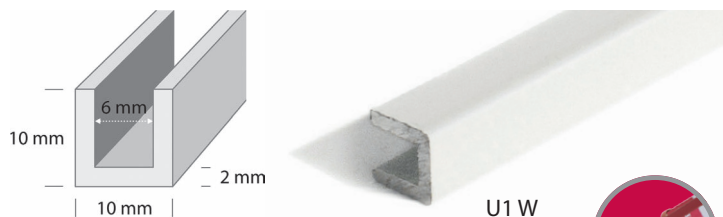

10 x 10 x 2 mm U-lista | U-profil | U-profile

TUOTENRO PRODUKTNR PRODUCT NO	VÄRI	FÄRG	COLOUR		PITUUS LÄNGD LENGTH	EAN-KOODI EAN-KOD EAN-CODE
U1 HE1	Hopea-anodisoitu	Silver anodiserad	Silver anodized		1000	 6 417083 121104
U1 HE2	Hopea-anodisoitu	Silver anodiserad	Silver anodized		2000	 6 417083 221101
U1 W1	Maalattu valkoinen	Vitmålad	Painted white		1000	 6 417083 191107
U1 W2	Maalattu valkoinen	Vitmålad	Painted white		2000	 6 417083 291104

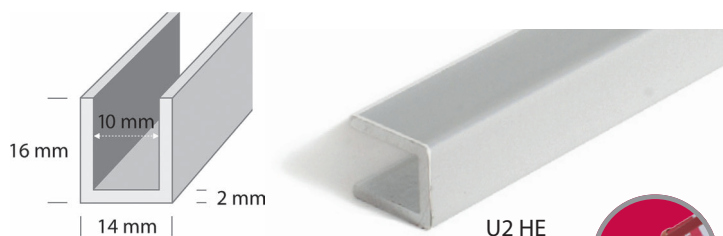

14 x 16 x 2 mm U-lista | U-profil | U-profile

TUOTENRO PRODUKTNR PRODUCT NO	VÄRI	FÄRG	COLOUR		PITUUS LÄNGD LENGTH	EAN-KOODI EAN-KOD EAN-CODE
U2 HE1	Hopea-anodisoitu	Silver anodiserad	Silver anodized		1000	 6 417083 122101
U2 HE2	Hopea-anodisoitu	Silver anodiserad	Silver anodized		2000	 6 417083 222108
U2 W1	Maalattu valkoinen	Vitmålad	Painted white		1000	 6 417083 192104
U2 W2	Maalattu valkoinen	Vitmålad	Painted white		2000	 6 417083 292101

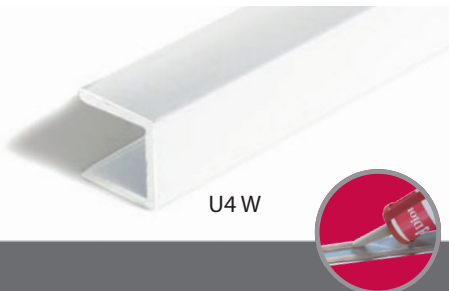
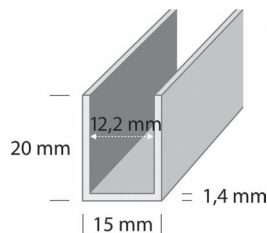

15 x 20 x 1,4 mm U-lista | U-profil | U-profile

TUOTENRO PRODUKTNR PRODUCT NO	VÄRI	FÄRG	COLOUR		PITUUS LÄNGD LENGTH	EAN-KOODI EAN-KOD EAN-CODE
U4 HE1	Hopea-anodisoitu	Silver anodiserad	Silver anodized		1000	 6 4 17083 124 112
U4 HE2	Hopea-anodisoitu	Silver anodiserad	Silver anodized		2000	 6 4 17083 224 102
U4 W1	Maalattu valkoinen	Vitmålad	Painted white		1000	 6 4 17083 194 108
U4 W2	Maalattu valkoinen	Vitmålad	Painted white		2000	 6 4 17083 294 105

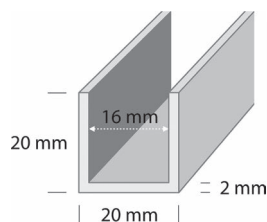

20 x 20 x 2 mm U-lista | U-profil | U-profile





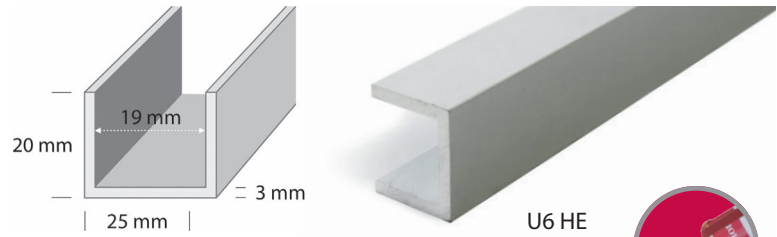



TUOTENRO PRODUKTNR PRODUCT NO	VÄRI	FÄRG	COLOUR		PITUUS LÄNGD LENGTH	EAN-KOODI EAN-KOD EAN-CODE
U5 HE1	Hopea-anodisoitu	Silver anodiserad	Silver anodized		1000	 6 4 17083 125 102
U5 HE2	Hopea-anodisoitu	Silver anodiserad	Silver anodized		2000	 6 4 17083 225 109
U5 W1	Maalattu valkoinen	Vitmålad	Painted white		1000	 6 4 17083 195 105
U5 W2	Maalattu valkoinen	Vitmålad	Painted white		2000	 6 4 17083 295 102

**HOBBY-TUOTTEET**  
**HOBBY-PRODUKTER**  
**HOBBY PRODUCTS**



25 x 20 x 3 mm U-lista | U-profil | U-profile



TUOTENRO PRODUKTNR PRODUCT NO	VÄRI	FÄRG	COLOUR		PITUUS LÄNGD LENGTH	EAN-KOODI EAN-KOD EAN-CODE
U6 HE1	Hopea-anodisoitu	Silver anodiserad	Silver anodized		1000	 6 417083 126109
U6 HE2	Hopea-anodisoitu	Silver anodiserad	Silver anodized		2000	 6 417083 226106
U6 W1	Maalattu valkoinen	Vitmålad	Painted white		1000	 6 417083 196102
U6 W2	Maalattu valkoinen	Vitmålad	Painted white		2000	 6 417083 296109

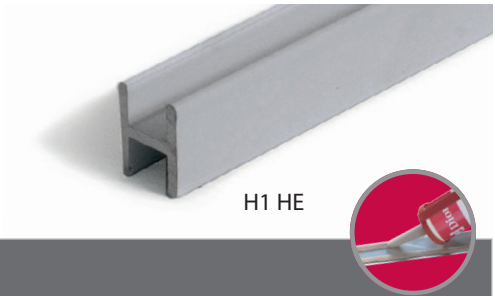
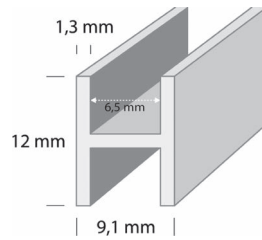

H1 HE

9,1 x 12 x 1,3 mm H-lista | H-profil | H-profile

TUOTENRO PRODUKTNR PRODUCT NO	VÄRI	FÄRG	COLOUR		PITUUS LÄNGD LENGTH	EAN-KOODI EAN-KOD EAN-CODE
H1 HE1	Hopea-anodisoitu	Silver anodiserad	Silver anodized		1000	 6 4 17083 12 1203
H1 HE2	Hopea-anodisoitu	Silver anodiserad	Silver anodized		2000	 6 4 17083 22 1200
H1 W1	Maalattu valkoinen	Vitmålad	Painted white		1000	 6 4 17083 19 1206
H1 W2	Maalattu valkoinen	Vitmålad	Painted white		2000	 6 4 17083 29 1203

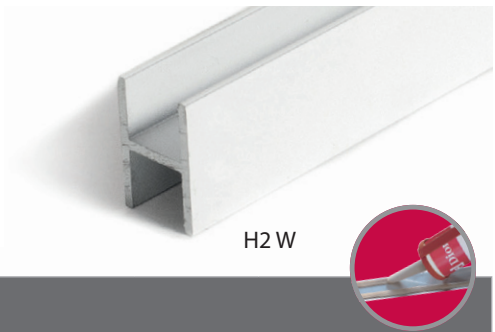
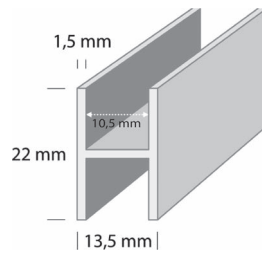

H2 W







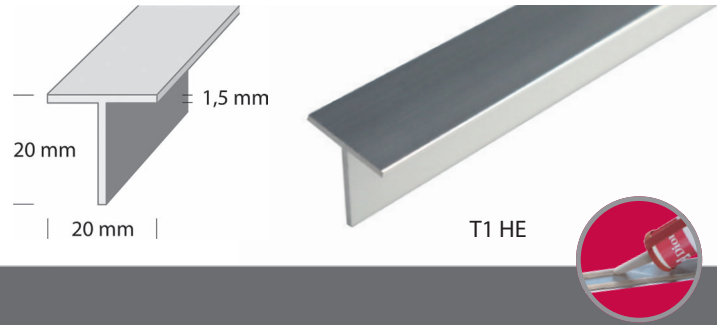

13,5 x 22 x 1,5 mm U-lista | U-profil | U-profile

TUOTENRO PRODUKTNR PRODUCT NO	VÄRI	FÄRG	COLOUR		PITUUS LÄNGD LENGTH	EAN-KOODI EAN-KOD EAN-CODE
H2 HE1	Hopea-anodisoitu	Silver anodiserad	Silver anodized		1000	 6 4 17083 12 2200
H2 HE2	Hopea-anodisoitu	Silver anodiserad	Silver anodized		2000	 6 4 17083 22 2207
H2 W1	Maalattu valkoinen	Vitmålad	Painted white		1000	 6 4 17083 19 2203
H2 W2	Maalattu valkoinen	Vitmålad	Painted white		2000	 6 4 17083 29 2200

**HOBBY-TUOTTEET**  
**HOBBY-PRODUKTER**  
**HOBBY PRODUCTS**







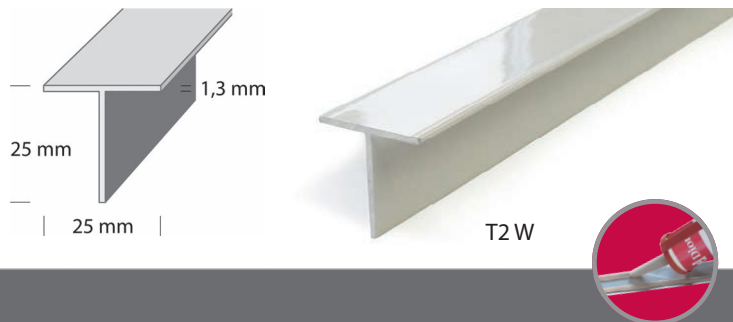



20 x 20 x 1,5 mm T-lista | T-profil | T-profile

TUOTENRO PRODUKTNR PRODUCT NO	VÄRI	FÄRG	COLOUR		PITUUS LÄNGD LENGTH	EAN-KOODI EAN-KOD EAN-CODE
T1 HE1	Hopea-anodisoitu	Silver anodiserad	Silver anodized		1000	 6 417083 121302
T1 HE2	Hopea-anodisoitu	Silver anodiserad	Silver anodized		2000	 6 417083 221309
T1 W1	Maalattu valkoinen	Vitmålad	Painted white		1000	 6 417083 191305
T1 W2	Maalattu valkoinen	Vitmålad	Painted white		2000	 6 417083 291302



25 x 25 x 1,3 mm T-lista | T-profil | T-profile

TUOTENRO PRODUKTNR PRODUCT NO	VÄRI	FÄRG	COLOUR		PITUUS LÄNGD LENGTH	EAN-KOODI EAN-KOD EAN-CODE
T2 HE1	Hopea-anodisoitu	Silver anodiserad	Silver anodized		1000	 6 417083 122309
T2 HE2	Hopea-anodisoitu	Silver anodiserad	Silver anodized		2000	 6 417083 222306
T2 W1	Maalattu valkoinen	Vitmålad	Painted white		1000	 6 417083 192302
T2 W2	Maalattu valkoinen	Vitmålad	Painted white		2000	 6 417083 292309

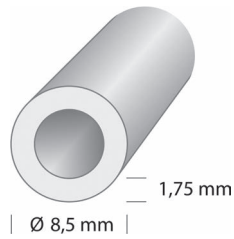

Ø 8,5 x 1,75 mm Putki | Rör | Tube

TUOTENRO PRODUKTNR PRODUCT NO	VÄRI	FÄRG	COLOUR		PITUUS LÄNGD LENGTH	EAN-KOODI EAN-KOD EAN-CODE
O10 HE1	Hopea-anodisoitu	Silver anodiserad	Silver anodized		1000	 6 4 17083 127403
O10 HE2	Hopea-anodisoitu	Silver anodiserad	Silver anodized		2000	 6 4 17083 227403
O10 W1	Maalattu valkoinen	Vitmålad	Painted white		1000	 6 4 17083 197403
O10 W2	Maalattu valkoinen	Vitmålad	Painted white		2000	 6 4 17083 297403

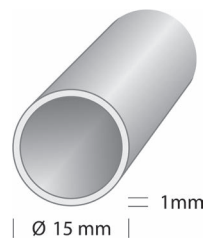

Ø 15 x 1 mm Putki | Rör | Tube

TUOTENRO PRODUKTNR PRODUCT NO	VÄRI	FÄRG	COLOUR		PITUUS LÄNGD LENGTH	EAN-KOODI EAN-KOD EAN-CODE
O1 HE1	Hopea-anodisoitu	Silver anodiserad	Silver anodized		1000	 6 4 17083 121401
O1 HE2	Hopea-anodisoitu	Silver anodiserad	Silver anodized		2000	 6 4 17083 221408
O1 W1	Maalattu valkoinen	Vitmålad	Painted white		1000	 6 4 17083 191404
O1 W2	Maalattu valkoinen	Vitmålad	Painted white		2000	 6 4 17083 291401

**HOBBY-TUOTTEET**  
**HOBBY-PRODUKTER**  
**HOBBY PRODUCTS**

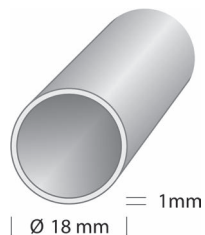

Ø 18 x 1 mm Putki | Rör | Tube

TUOTENRO PRODUKTNR PRODUCT NO	VÄRI	FÄRG	COLOUR		PITUUS LÄNGD LENGTH	EAN-KOODI EAN-KOD EAN-CODE
O2 HE1	Hopea-anodisoitu	Silver anodiserad	Silver anodized		1000	 6 417083 122408
O2 HE2	Hopea-anodisoitu	Silver anodiserad	Silver anodized		2000	 6 417083 222405
O2 W1	Maalattu valkoinen	Vitmålad	Painted white		1000	 6 417083 192401
O2 W2	Maalattu valkoinen	Vitmålad	Painted white		2000	 6 417083 292408

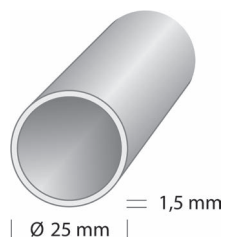

Ø 25 x 1,5 mm Putki | Rör | Tube

TUOTENRO PRODUKTNR PRODUCT NO	VÄRI	FÄRG	COLOUR		PITUUS LÄNGD LENGTH	EAN-KOODI EAN-KOD EAN-CODE
O3 HE1	Hopea-anodisoitu	Silver anodiserad	Silver anodized		1000	 6 417083 123405
O3 HE2	Hopea-anodisoitu	Silver anodiserad	Silver anodized		2000	 6 417083 223402
O3 W1	Maalattu valkoinen	Vitmålad	Painted white		1000	 6 417083 193408
O3 W2	Maalattu valkoinen	Vitmålad	Painted white		2000	 6 417083 293405

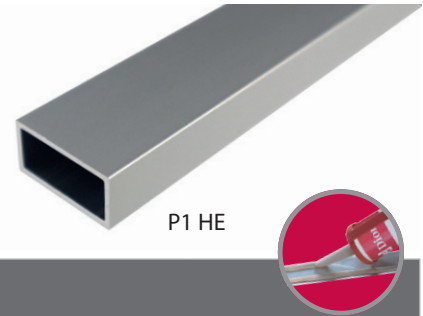
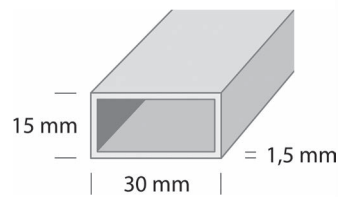

30 x 15 x 1,5 mm Palkki | Fyrkantrör | Plank

TUOTENRO PRODUKTNR PRODUCT NO	VÄRI	FÄRG	COLOUR		PITUUS LÄNGD LENGTH	EAN-KOODI EAN-KOD EAN-CODE
P1 HE1	Hopea-anodisoitu	Silver anodiserad	Silver anodized		1000	 6 4 17083 121500
P1 HE2	Hopea-anodisoitu	Silver anodiserad	Silver anodized		2000	 6 4 17083 221507
P1 W1	Maalattu valkoinen	Vitmålad	Painted white		1000	 6 4 17083 191503
P1 W2	Maalattu valkoinen	Vitmålad	Painted white		2000	 6 4 17083 291500

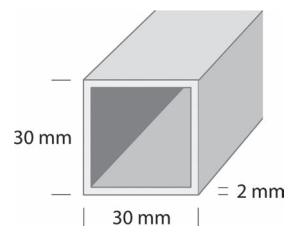







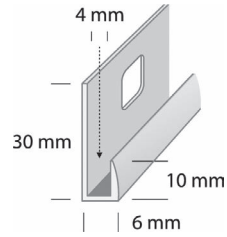











30 x 30 x 2 mm Palkki | Fyrkantrör | Plank

TUOTENRO PRODUKTNR PRODUCT NO	VÄRI	FÄRG	COLOUR		PITUUS LÄNGD LENGTH	EAN-KOODI EAN-KOD EAN-CODE
P2 HE1	Hopea-anodisoitu	Silver anodiserad	Silver anodized		1000	 6 4 17083 122507
P2 HE2	Hopea-anodisoitu	Silver anodiserad	Silver anodized		2000	 6 4 17083 222504
P2 W1	Maalattu valkoinen	Vitmålad	Painted white		1000	 6 4 17083 192500
P2 W2	Maalattu valkoinen	Vitmålad	Painted white		2000	 6 4 17083 292507

**HOBBY-TUOTTEET**  
**HOBBY-PRODUKTER**  
**HOBBY PRODUCTS**





30 x 6 mm Peililista | Spegelprofil | Mirror profile

TUOTENRO PRODUKTNR PRODUCT NO	VÄRI	FÄRG	COLOUR		PITUUS LÄNGD LENGTH	EAN-KOODI EAN-KOD EAN-CODE
J1 CBL1	Carbon black	Carbon black	Carbon black		1000	 6 417 083 039065
J1 CBL2	Carbon black	Carbon black	Carbon black		2000	 6 417 083 039072
J1 CBL3	Carbon black	Carbon black	Carbon black		3000	 6 417 083 039089
J1 HE1	Hopea-anodisoitu	Silver anodiserad	Silver anodized		1000	 6 417 083 100338
J1 HE2	Hopea-anodisoitu	Silver anodiserad	Silver anodized		2000	 6 417 083 200632
J1 W1	Maalattu valkoinen	Vitmålad	Painted white		1000	 6 417 083 133015
J1 W2	Maalattu valkoinen	Vitmålad	Painted white		2000	 6 417 083 263521
PL 4-02	Hopea-anodisoitu	Silver anodiserad	Silver anodized		2700	 6 417 083 351020
PL 4-W	Maalattu valkoinen	Vitmålad	Painted white		2700	 6 417 083 351075

# Dione® MEKANO



 Dione MEKANO -teräsputkista ja erilaisista liitososista syntyy uniikkeja putkikalusteita moniin eri käyttötärpeisiin.

 Dione MEKANO stålrör och olika kopplingsdelar bildar unika möbler för många olika ändamål.





 Dione MEKANO steel tubes and various clamps form a unique pipe furniture solutions for various purposes.

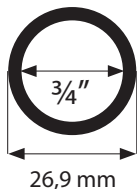

# Dione MEKANO®



ø 26,9 mm Putket, maalattu musta | Rör, svart målad | Tubes, painted black

TUOTENRO PRODUKTNR PRODUCT NO	PITUUS LÄNGD LENGTH	EAN-KOODI EAN-KOD EAN-CODE
ST269 BL 40	40 cm	 6 4 17083 035401
ST269 BL 100	100 cm	 6 4 17083 035418
ST269 BL 200	200 cm	 6 4 17083 035425
ST269 BL 300	300 cm	 6 4 17083 035432

ø 26,9 mm Liittimet, maalattu musta | Kopplingar, svart målad | Clamps, painted black

TUOTENRO PRODUKTNR PRODUCT NO	TUOTE	PRODUKT	PRODUCT		EAN-KOODI EAN-KOD EAN-CODE
100B BL 269	Kaarikiinnike	Bågfäste	Cap bracket		 6 4 17083 035388
10B BL 269	Pyöreä laippaliitin	Runt flänsfäste	Flange, round		 6 4 17083 035319
18B BL 269	Kolmikulmaliitin	Trevägsdel	Three way top corner		 6 4 17083 035326
20B BL 269	Ristiliitin 90°	Fyrvägsdel för genomgående rör 90°	Corner with through tube 90°		 6 4 17083 035333
2B BL 269	T-liitin	T-del	T-joint		 6 4 17083 035289
34B BL 269	Seinäkiinnike	Väggfäste för genomgående rör	Handrail support		 6 4 17083 035340



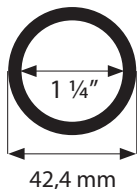

ø 26,9 mm Liittimet, maalattu musta | Kopplingar, svart målad | Clamps, painted black

TUOTENRO PRODUKTNR PRODUCT NO	TUOTE	PRODUKT	PRODUCT		EAN-KOODI EAN-KOD EAN-CODE
36B BL 269	Uroskiinnike	Enkelfäste	Male single lug		
64B BL 269	Takkikoukku	Krok	Coat hook		
6B BL 269	Kulmaliitin 90°	Hörndel 90°	Elbow 90°		
55B BL 269	Kauluskiinnike	Enkelfäste vägg	Collar plate single side		
8B BL 269	Suora liitin	Rak förlängning	Straight coupling		
22B BL 269	4-tieliitin	Fyr-kors	Four-cross		
73B BL 269	Metallitulppa	Ändplugg	Metal plug		
SW50 BL	Kääntöpyörä 50 mm	Hjul 50 mm	Swivel wheel 50 mm		
ZW E269	Sovitin SW 50 kääntöpyörälle	Expander för SW 50 hjul	Expander for SW 50 Swivel wheel		

# Dione MEKANO®



ø 42,4 mm Putket, maalattu musta | Rör, svart målad | Tubes, painted black

TUOTENRO PRODUKTNR PRODUCT NO	PITUUS LÄNGD LENGTH	EAN-KOODI EAN-KOD EAN-CODE
ST424 BL 40	40 cm	 6 4 17083 035562
ST424 BL 100	100 cm	 6 4 17083 035579
ST424 BL 200	200 cm	 6 4 17083 035586
ST424 BL 300	300 cm	 6 4 17083 035593

ø 42,4 mm Liittimet, maalattu musta | Kopplingar, svart målad | Clamps, painted black



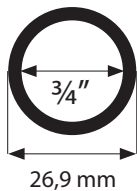

TUOTENRO PRODUKTNR PRODUCT NO	TUOTE	PRODUKT	PRODUCT		EAN-KOODI EAN-KOD EAN-CODE
100D BL 424	Kaarikiinnike	Bågfäste	Cap bracket		 6 4 17083 035548
10D BL 424	Pyöreä laippaliitin	Runt flänsfäste	Flange, round		 6 4 17083 035470
18D BL 424	Kolmikulmaliitin	Trevägsdel	Three way top corner		 6 4 17083 035487
20D BL 424	Ristiliitin 90°	Fyrvägsdel för genomgående rör 90°	Corner with through tube 90°		 6 4 17083 035494
2D BL 424	T-liitin	T-del	T-joint		 6 4 17083 035449
34D BL 424	Seinäkiinnike	Väggfäste för genomgående rör	Handrail support		 6 4 17083 035500

∅ 42,4 mm Liittimet, maalattu musta | Kopplingar, svart målad | Clamps, painted black

TUOTENRO PRODUKTNR PRODUCT NO	TUOTE	PRODUKT	PRODUCT		EAN-KOODI EAN-KOD EAN-CODE
36D BL 424	Uroskiinnike	Enkelfäste	Male single lug		
64D BL 424	Takkikoukku	Krok	Coat hook		
6D BL 424	Kulmaliitin 90°	Hörndel 90°	Elbow 90°		
55D BL 424	Kauluskiinnike	Enkelfäste vägg	Collar plate single side		
8D BL 424	Suora liitin	Rak förlängning	Straight coupling		
22D BL 424	4-tieliitin	Fyr-kors	Four-cross		
73D BL 424	Metallitulppa	Ändplugg	Metal plug		
SW50 BL	Kääntöpyörä 50 mm	Hjul 50 mm	Swivel wheel 50 mm		
ZW E424	Sovitin SW 50 kääntöpyörälle	Expander för SW 50 hjul	Expander for SW 50 Swivel wheel		















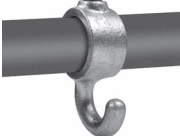



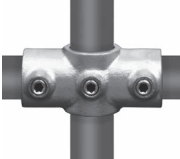

## Ø 26,9 mm Putket, sinkitty teräs | Rör, galvaniserat | Tubes, galvanized

TUOTENRO PRODUKTNR PRODUCT NO	PITUUS LÄNGD LENGTH	EAN-KOODI EAN-KOD EAN-CODE
ST269 SI 40	40 cm	 6 4 17083 035043
ST269 SI 100	100 cm	 6 4 17083 035067
ST269 SI 200	200 cm	 6 4 17083 035074
ST269 SI 300	300 cm	 6 4 17083 035081

## Ø 26,9 mm Liittimet, sinkitty teräs | Kopplingar, galvaniserat | Clamps, galvanized



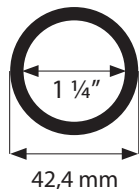

TUOTENRO PRODUKTNR PRODUCT NO	TUOTE	PRODUKT	PRODUCT		EAN-KOODI EAN-KOD EAN-CODE
100B SI 269	Kaarikiinnike	Bågfäste	Cap bracket		 6 4 17083 035005
10B SI 269	Pyöreä laippaliitin	Runt flänsfäste	Flange, round		 6 4 17083 034930
18B SI 269	Kolmikulmaliitin	Trevägsdel	Three way top corner		 6 4 17083 034947
20B SI 269	Ristiliitin 90°	Fyrvägsdel för genomgående rör 90°	Corner with through tube 90°		 6 4 17083 034954
2B SI 269	T-liitin	T-del	T-joint		 6 4 17083 034909
34B SI 269	Seinäkiinnike	Väggfäste för genomgående rör	Handrail support		 6 4 17083 034961

ø 26,9 mm Liittimet, sinkitty teräs | Kopplingar, galvaniserat | Clamps, galvanized

TUOTENRO PRODUKTNR PRODUCT NO	TUOTE	PRODUKT	PRODUCT		EAN-KOODI EAN-KOD EAN-CODE
36B SI 269	Uroskiinnike	Enkelfäste	Male single lug		
64B SI 269	Takkikoukku	Krok	Coat hook		
6B SI 269	Kulmaliitin 90°	Hörndel 90°	Elbow 90°		
55B SI 269	Kauluskiinnike	Enkelfäste vägg	Collar plate single side		
8B SI 269	Suora liitin	Rak förlängning	Straight coupling		
22B SI 269	4-tieliitin	Fyr-kors	Four-cross		
73B SI 269	Metallitulppa	Ändplugg	Metal plug		
SW50 SI	Kääntöpyörä 50 mm	Hjul 50 mm	Swivel wheel 50 mm		
ZW E269	Sovitin SW 50 kääntöpyörälle	Expander för SW 50 hjul	Expander for SW 50 Swivel wheel		















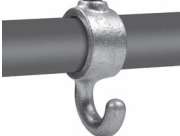



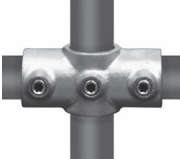

ø 42,4 mm Putket, sinkitty teräs | Rör, galvaniserat | Tubes, galvanized

TUOTENRO PRODUKTNR PRODUCT NO	PITUUS LÄNGD LENGTH	EAN-KOODI EAN-KOD EAN-CODE
ST424 SI 40	40 cm	 6 4 17083 035241
ST424 SI 100	100 cm	 6 4 17083 035258
ST424 SI 200	200 cm	 6 4 17083 035265
ST424 SI 300	300 cm	 6 4 17083 035272

ø 42,4 mm Liittimet, sinkitty teräs | Kopplingar, galvaniserat | Clamps, galvanized

TUOTENRO PRODUKTNR PRODUCT NO	TUOTE	PRODUKT	PRODUCT		EAN-KOODI EAN-KOD EAN-CODE
100D SI 424	Kaarikiinnike	Bågfäste	Cap bracket		 6 4 17083 035203
10D SI 424	Pyöreä laippaliitin	Runt flänsfäste	Flange, round		 6 4 17083 035135
18D SI 424	Kolmikulmaliitin	Trevägsdel	Three way top corner		 6 4 17083 035142
20D SI 424	Ristiliitin 90°	Fyrvägsdel för genomgående rör 90°	Corner with through tube 90°		 6 4 17083 035159
2D SI 424	T-liitin	T-del	T-joint		 6 4 17083 035098
34D SI 424	Seinäkiinnike	Väggfäste för genomgående rör	Handrail support		 6 4 17083 035166

ø 42,4 mm Liittimet, sinkitty teräs | Kopplingar, galvaniserat | Clamps, galvanized

TUOTENRO PRODUKTNR PRODUCT NO	TUOTE	PRODUKT	PRODUCT		EAN-KOODI EAN-KOD EAN-CODE
36D SI 424	Uroskiinnike	Enkelfäste	Male single lug		 6 417 083 035 173
64D SI 424	Takkikoukku	Krok	Coat hook		 6 417 083 035 180
6D SI 424	Kulmaliitin 90°	Hörndel 90°	Elbow 90°		 6 417 083 035 104
55D SI 424	Kauluskiinnike	Enkelfäste vägg	Collar plate single side		 6 417 083 035 197
8D SI 424	Suora liitin	Rak förlängning	Straight coupling		 6 417 083 035 111
22D SI 424	4-tieliitin	Fyr-kors	Four-cross		 6 417 083 040 160
73D SI 424	Metallitulppa	Ändplugg	Metal plug		 6 417 083 035 210
SW50 SI	Kääntöpyörä 50 mm	Hjul 50 mm	Swivel wheel 50 mm		 6 417 083 035 036
ZW E424	Sovitin SW 50 kääntöpyörälle	Expander för SW 50 hjul	Expander for SW 50 Swivel wheel		 6 417 083 035 227



**ACH-600**  
sivu/sidan/page  
267



**ISH-500**  
sivu/sidan/page  
273

# TARKASTUSLUUKUT INSPEKTIONSLUCKOR ACCESS PANELS

## **VARMISTA SUJUVA PÄÄSY TARKASTUSTA VAATIVIIN KOHTEISIIN.**

Dione-tarkastusluukut soveltuvat kaikille seinä- ja kattopinnoille. Laajasta valikoimastamme löydät toimivan ratkaisun tarvittavilla ominaisuuksilla – esimerkiksi ilma- ja pölytiivit tarkastusluukut, äänieristetyt tarkastusluukut sekä paloluukut. Saatavilla myös mittatilauksena.

## **SÄKERSTÄLL SMIDIG ÅTKOMST TILL INSPEKTIONSKRÄVANDE OMRÅDEN.**

Dione-inspektionsluckor lämpar sig för alla vägg- och takytor. I vårt breda sortiment hittar du en funktionell lösning med rätt egenskaper – till exempel luft- och dammtäta inspektionsluckor, ljudisolerade inspektionsluckor samt brandluckor. Finns även som måttbeställning.

## **ENSURE SMOOTH ACCESS TO AREAS REQUIRING INSPECTION.**

Dione access panels are suitable for all wall and ceiling surfaces. Our wide range offers functional solutions with the required properties – including air- and dust-tight access panels, sound-insulated access panels, and fireproof access panels. Custom sizes are also available.

**ACH TARKASTUSLUUKUT NELIÖLUKOLLA**  
**ACH INSPEKTIONSLUCKOR MED FYRKANTSLÅS**  
**ACH ACCESS PANELS WITH SQUARE LOCK**

**seinään ja kattoon**  
**för vägg och tak**  
**for wall and ceiling**

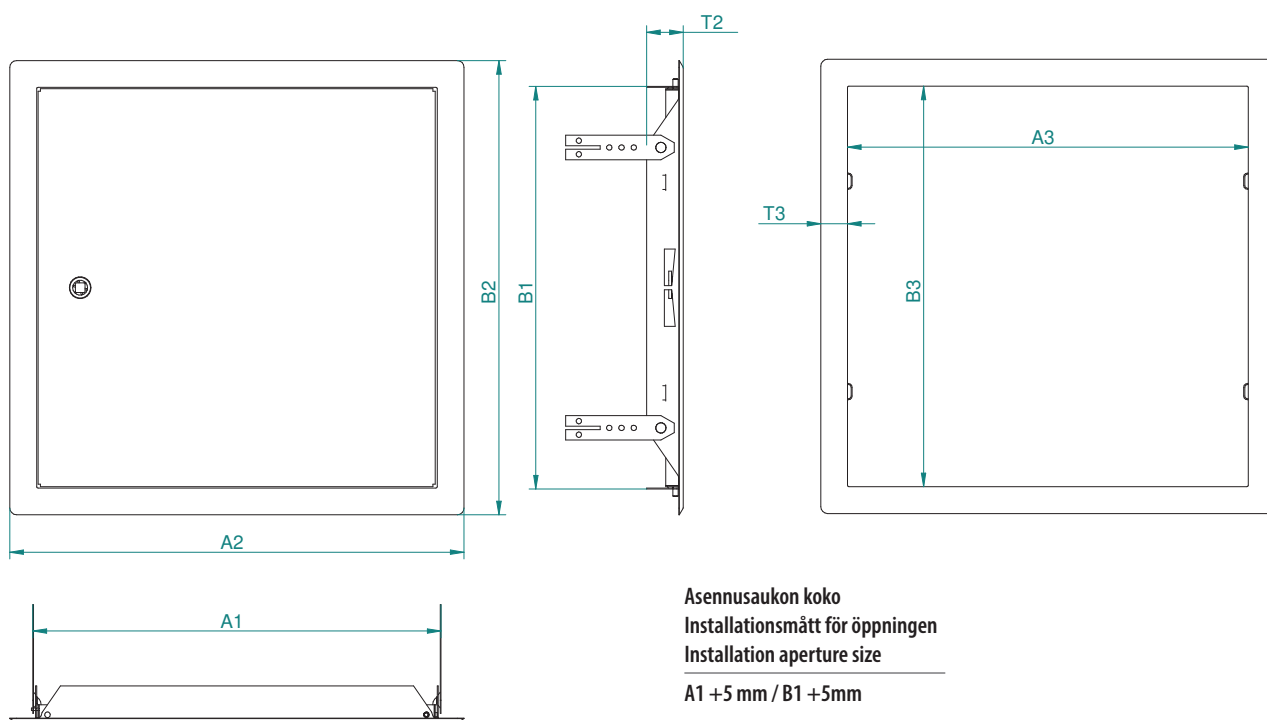

**Asennusaukon koko**  
**Installationsmått för öppningen**  
**Installation aperture size**  
**A1 +5 mm / B1 +5mm**



- Neliölukko (7 mm)
- Materiaali sinkitty teräs
- RAL9016 valkoinen polttomaalattu pinta. Muut RAL-sävyt saatavana tilauksesta
- Ovi irroitettavissa ja kätsisyys vaihdettavissa
- Korkeuden ollessa 600mm tai yli varustettu kahdella lukolla



- Fyrkantsslås (7 mm)
- Material galvaniserat stål
- RAL9016 vit emaljerad finish. Andra RAL-färger tillgängliga på beställning
- Luckan är avtagbar, vändbar hängning
- Från höjd 600 mm är den utrustad med två lås



- Square lock (7 mm)
- Material galvanized steel
- RAL9016 white baked enamel finish. Other RAL colours available on order
- Detachable door, reversible handing
- From a height of 600 mm, equipped with two locks



**MITTILAUSTUOTTEET**

- Koot 150x150 mm ▶ 1200x1600 mm, 10 mm välein
- Saatavana sylinteri- tai Abloy-lukolla



**MÅTTBESTÄLLDA PRODUKTER**

- Storlekar 150x150 mm ▶ 1200x1600 mm, 10 mm steg
- Finns även med cylinder- eller Abloy-lås























**CUSTOM-MADE PRODUCTS**

- Sizes 150x150 mm ▶ 1200x1600 mm, 10 mm grid
- Also available with a cylinder lock or an Abloy lock

**seinään ja kattoon**  
för vägg och tak  
for wall and ceiling

**ACH TARKASTUSLUUKUT NELIÖLUKOLLA**  
ACH INSPEKTIONSLUCKOR MED FYRKANTSLÅS  
ACH ACCESS PANELS WITH SQUARE LOCK

TUOTENRO PRODUKTNR PRODUCT NO	KOKO STORLEK SIZE	SISÄMITAT INNERMÅTT INNER DIMENSIONS A1 x B1	ULKOMITAT YTTERMÅTT OUTER DIMENSIONS A2 x B2	AUKKO ÖPPNING OPENING A3 x B3	SYVYYS/LEVEYS DJUP / BREDD DEPTH / WIDTH T2 / T3	EAN-KOODI EAN-KOD EAN-CODE
ACH-150	150x150 mm	150x150 mm	185x185 mm	145x145 mm	27 / 20 mm	 6 417083 422003
ACH-1520	150x200 mm	150x200 mm	185x235 mm	145x195 mm	27 / 20 mm	 6 417083 019685
ACH-200	200x200 mm	200x200 mm	235x235 mm	195x195 mm	27 / 20 mm	 6 417083 421907
ACH-2025	200x250 mm	200x250 mm	235x285 mm	195x245 mm	27 / 20 mm	 6 417083 019692
ACH-2030	200x300 mm	200x300 mm	235x335 mm	195x295 mm	27 / 20 mm	 6 417083 034343
ACH-250	250x250 mm	250x250 mm	285x285 mm	245x245 mm	27 / 20 mm	 6 417083 019708
ACH-2530	250x300 mm	250x300 mm	285x335 mm	245x295 mm	27 / 20 mm	 6 417083 019715
ACH-300	300x300 mm	300x300 mm	335x335 mm	295x295 mm	27 / 20 mm	 6 417083 421914
ACH-3040	300x400 mm	294x394 mm	338x438 mm	268x368 mm	21 / 25 mm	 6 417083 019722
ACH-3050	300x500 mm	294x494 mm	338x538 mm	268x468 mm	21 / 25 mm	 6 417083 019739
ACH-3060	300x600 mm	294x594 mm	338x638 mm	268x568 mm	21 / 25 mm	 6 417083 019746
ACH-350	350x350 mm	344x344 mm	388x388 mm	318x318 mm	21 / 25 mm	 6 417083 019753
ACH-400	400x400 mm	400x400 mm	435x435 mm	395x395 mm	27 / 20 mm	 6 417083 421921
ACH-4050	400x500 mm	394x494 mm	438x538 mm	368x468 mm	21 / 25 mm	 6 417083 019760
ACH-4060	400x600 mm	394x594 mm	438x638 mm	368x568 mm	21 / 25 mm	 6 417083 019777
ACH-450	450x450 mm	444x444 mm	488x488 mm	418x418 mm	21 / 25 mm	 6 417083 019784
ACH-500	500x500 mm	494x494 mm	538x538 mm	468x468 mm	21 / 25 mm	 6 417083 421938
ACH-5060	500x600 mm	494x594 mm	538x638 mm	468x568 mm	21 / 25 mm	 6 417083 034091
ACH-600	600x600 mm	594x594 mm	638x638 mm	568x568 mm	21 / 25 mm	 6 417083 421945
ACH-6080	600x800 mm	594x794 mm	638x838 mm	568x768 mm	21 / 25 mm	 6 417083 019791
ACH-800	800x800 mm	794x794 mm	838x838 mm	768x768 mm	21 / 25 mm	 6 417083 019807

**ACP PUSH-UP TARKASTUSLUUKUT**  
**ACP INSPEKTIONSLUCKOR MED TRYCKLÅSNING**  
**ACP ACCESS PANELS WITH PUSH LOCK**

**seinään ja kattoon**  
**för vägg och tak**  
**for wall and ceiling**

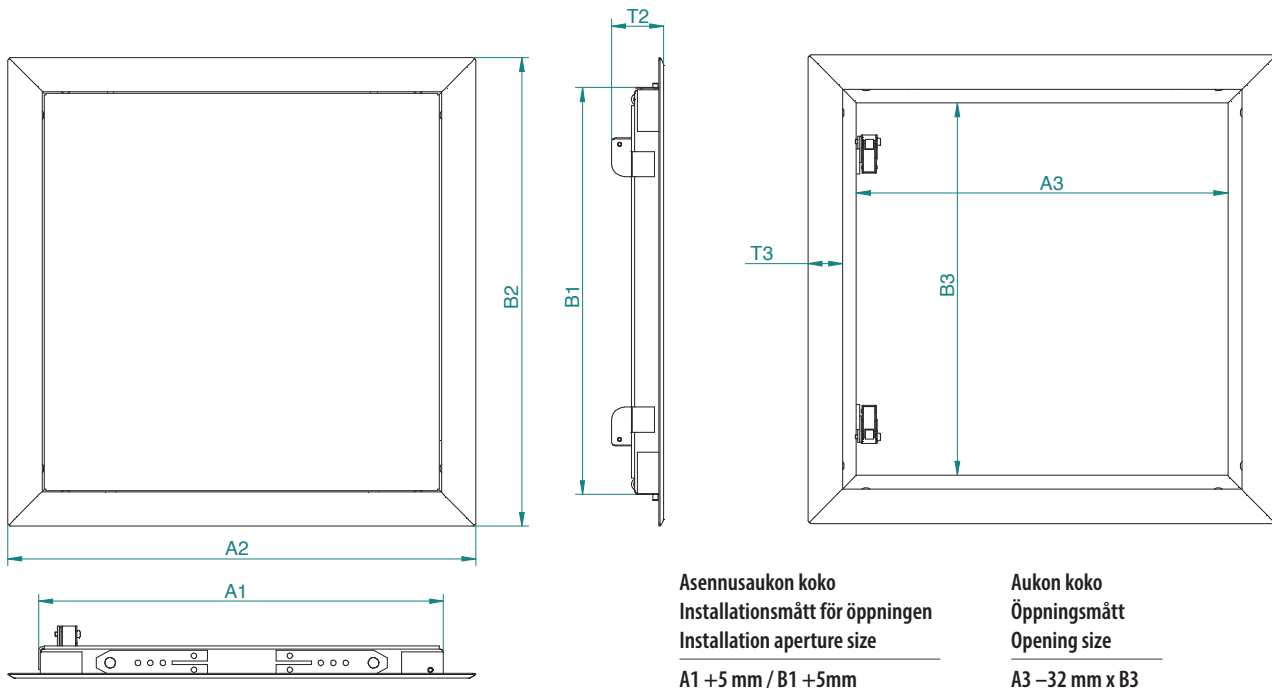

- Push-up-lukitus
- Materiaali sinkitty teräs
- RAL9016 valkoinen polttomaalattu pinta. Muut RAL-sävyt saatavana tilauksesta
- Ovi irroitettavissa ja käisyys vaihdettavissa



- Trycklåsning
- Material galvaniserat stål
- RAL9016 vit emaljerad finish. Andra RAL-färger tillgängliga på beställning
- Luckan är avtagbar, vändbar hängning



- Push lock
- Material galvanized steel
- RAL9016 white baked enamel finish. Other RAL colours available on order
- Detachable door, reversible handing

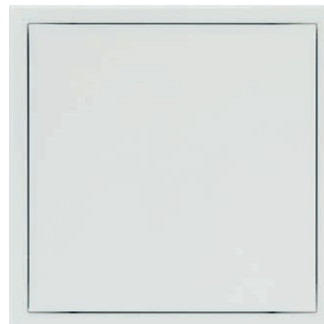

**MITTATILAUSTUOTTEET**  
 Koot 150x150 mm ▶ 1000x1000 mm, 10 mm välein



**MÅTTBESTÄLLDA PRODUKTER**  
 Storlekar 150x150 mm ▶ 1000x1000 mm, 10 mm steg



**CUSTOM-MADE PRODUCTS**  
 Sizes 150x150 mm ▶ 1000x1000 mm, 10 mm grid

**seinään ja kattoon**  
**för vägg och tak**  
 for wall and ceiling

**ACP PUSH-UP TARKASTUSLUUKUT**  
**ACP INSPEKTIONSLUCKOR MED TRYCKLÅSNING**  
 ACP PUSH LOCK ACCESS PANELS

TUOTENRO PRODUKTI PRODUCT NO	KOKO STORLEK SIZE	SISÄMITAT INNERMÅTT INNER DIMENSIONS A1 x B1	ULKOMITAT YTTERMÅTT OUTER DIMENSIONS A2 x B2	AUKKO ÖPPNING OPENING A3 x B3	SYVYYS/LEVEYS DJUP / BREDD DEPTH / WIDTH T2 / T3	EAN-KOODI EAN-KOD EAN-CODE
ACP-150	150x150 mm	150x150 mm	185x185 mm	145x145 mm	38 / 20 mm	 6 417 083 018 923
ACP-200	200x200 mm	200x200 mm	235x235 mm	195x195 mm	38 / 20 mm	 6 417 083 018 930
ACP-300	300x300 mm	300x300 mm	335x335 mm	295x295 mm	38 / 20 mm	 6 417 083 018 947
ACP-400	400x400 mm	400x400 mm	435x435 mm	395x395 mm	38 / 20 mm	 6 417 083 018 954
ACP-500	500x500 mm	494x494 mm	538x538 mm	468x468 mm	38 / 25 mm	 6 417 083 018 961
ACP-600	600x600 mm	594x594 mm	638x638 mm	568x568 mm	38 / 25 mm	 6 417 083 018 978

**ACT ILMA-JA PÖLYTIIVIIT TARKASTUSLUUKUT**  
**ACT LUFT- OCH DAMMTÄTA INSPEKTIONSLUCKOR**  
**ACT AIR AND DUST-TIGHT ACCESS PANELS**

**seinään ja kattoon**  
**för vägg och tak**  
**for wall and ceiling**

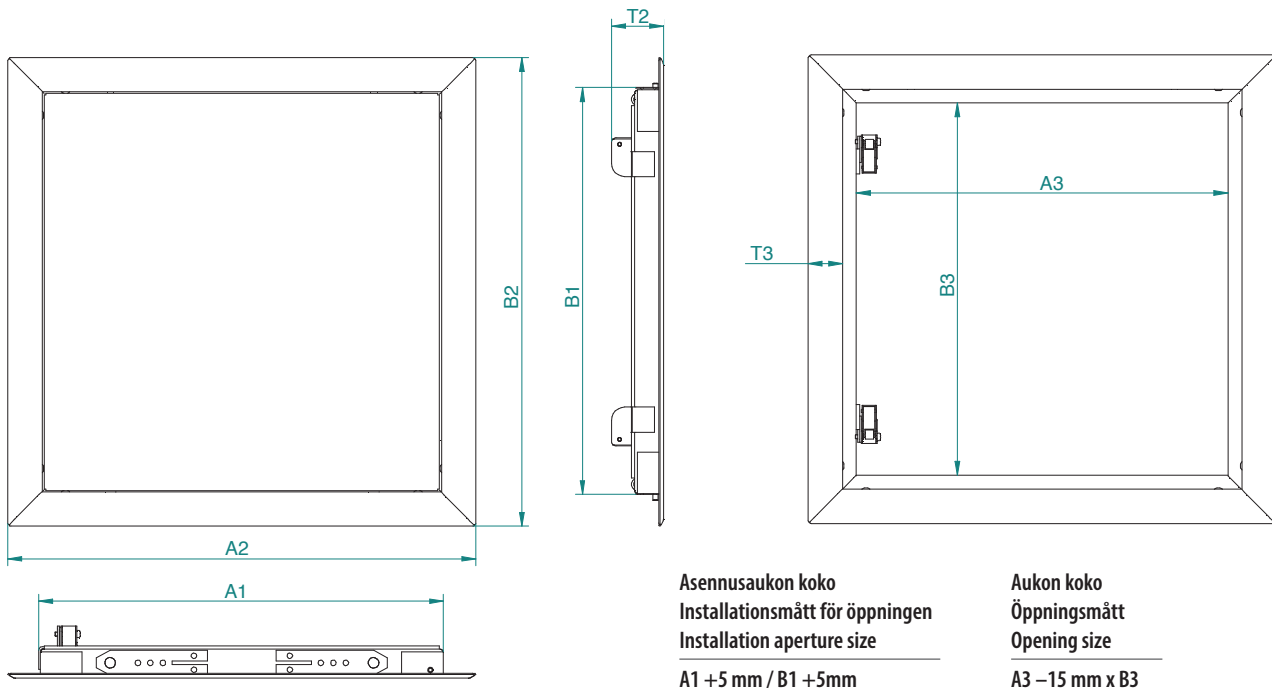

**Asennusaukon koko**  
**Installationsmått för öppningen**  
**Installation aperture size**  
**A1 +5 mm / B1 +5mm**

**Aukon koko**  
**Öppningsmått**  
**Opening size**  
**A3 –15 mm x B3**



- Push-up-lukitus
- Ilma- ja pölytiivis
- Soveltuu märkätiloihin
- Materiaali sinkitty teräs
- RAL9016 valkoinen polttomaalattu pinta. Muut RAL-sävyt saatavana tilauksesta
- Ovi irroitettavissa ja kätsiys vaihdettavissa

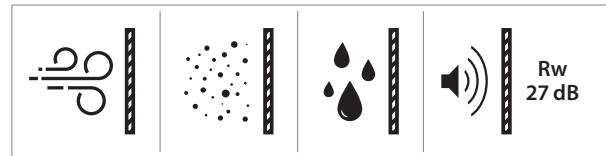

- Trycklåsning
- Luft- och dammtät
- Lämplig för våtrum
- Material galvaniserat stål
- RAL9016 vit emaljerad finish. Andra RAL-färger tillgängliga på beställning
- Luckan är avtagbar, vändbar hängning

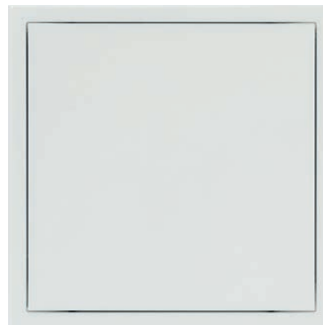

- Push lock
- Air and dust-tight
- Suitable for wet rooms
- Material galvanized steel
- RAL9016 white baked enamel finish. Other RAL colours available on order
- Detachable door, reversible handing



**MITTATILAUSTUOTTEET**  
 Koot 150x150 mm ▶ 1000x1000 mm, 50 mm välein



**MÄTTBESTÄLLDA PRODUKTER**  
 Storlekar 150x150 mm ▶ 1000x1000 mm, 50 mm steg



**CUSTOM-MADE PRODUCTS**  
 Sizes 150x150 mm ▶ 1000x1000 mm, 50 mm grid

**seinään ja kattoon**  
**för vägg och tak**  
**for wall and ceiling**

**ACT ILMA-JA PÖLYTIIVIIT TARKASTUSLUUKUT**  
**ACT LUFT- OCH DAMMTÄTA INSPEKTIONSLUCKOR**  
**ACT AIR AND DUST-TIGHT ACCESS PANELS**

TUOTENRO PRODUKTNR PRODUCT NO	KOKO STORLEK SIZE	SISÄMITAT INNERMÅTT INNER DIMENSIONS A1 x B1	ULKOMITAT YTTERMÅTT OUTER DIMENSIONS A2 x B2	AUKKO ÖPPNING OPENING A3 x B3	SYVYYS/LEVEYS DJUP / BREDD DEPTH / WIDTH T2 / T3	EAN-KOODI EAN-KOD EAN-CODE
ACT-200	200x200 mm	194x194 mm	238x238 mm	168x168 mm	38 / 25 mm	 6 417 083 018 985
ACT-300	300x300 mm	294x294 mm	338x338 mm	268x268 mm	38 / 25 mm	 6 417 083 018 992
ACT-400	400x400 mm	394x394 mm	438x438 mm	368x368 mm	38 / 25 mm	 6 417 083 019 005
ACT-500	500x500 mm	494x494 mm	538x538 mm	468x468 mm	38 / 25 mm	 6 417 083 019 012
ACT-600	600x600 mm	594x594 mm	638x638 mm	568x568 mm	38 / 25 mm	 6 417 083 019 029

# ISH ÄÄNIERISTYSLUUKUT

## ISH LJUDISOLERAD INSPEKTIONSLUCKOR

### ISH SOUND INSULATED ACCESS PANELS

seinään ja kattoon  
för vägg och tak  
for wall and ceiling

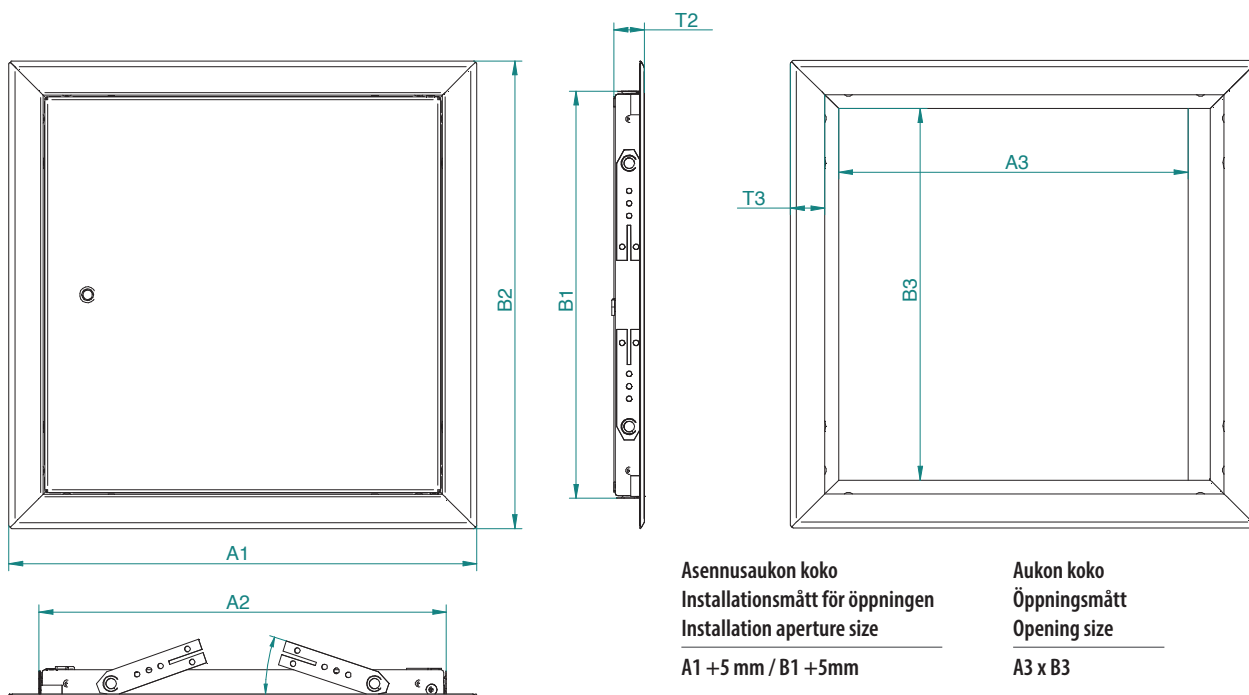

- Neliölukko (7 mm)
- Materiaali sinkitty teräs
- RAL9016 valkoinen polttomaalattu pinta
- Äänenvaimennus Rw 31 dB
- 400 x 400 mm ja suuremmat koot varustettu kahdella lukolla



- Fyrkantsslås (7 mm)
- Material galvaniserat stål
- RAL9016 vit emaljerad finish. Andra RAL-färger tillgängliga på beställning
- Ljudreduktion Rw 31 dB
- Utrustad med två lås från storlek 400 x 400 mm



- Square lock (7 mm)
- Material galvanized steel
- RAL9016 white baked enamel finish. Other RAL colours available on order
- Sound reduction Rw 31 dB
- Equipped with two locks from size 400 x 400 mm



#### MITTATILAUSTUOTTEET

Koot 200x200 mm ▶ 1000x1000 mm, 50 mm välein



#### MÄTTBESTÄLLDA PRODUKTER

Storlekar 200x200 mm ▶ 1000x1000 mm, 50 mm steg



#### CUSTOM-MADE PRODUCTS

Sizes 200x200 mm ▶ 1000x1000 mm, 50 mm grid

**seinään ja kattoon**  
**för vägg och tak**  
**for wall and ceiling**

**ISH ÄÄNIERISTYSLUUKUT**  
**ISH LJUDISOLERAD INSPEKTIONSLUCKOR**  
**ISH SOUND INSULATED ACCESS PANELS**

TUOTENRO PRODUKTI PRODUCT NO	KOKO STORLEK SIZE	SISÄMITAT INNERMÅTT INNER DIMENSIONS A1 x B1	ULKOMITAT YTTERMÅTT OUTER DIMENSIONS A2 x B2	AUKKO ÖPPNING OPENING A3 x B3	SYVYYS/LEVEYS DJUP / BREDD DEPTH / WIDTH T2 / T3	EAN-KOODI EAN-KOD EAN-CODE
ISH-200	200x200 mm	194x194 mm	238x238 mm	152x168 mm	22 / 25 mm	 6 4 1 7 0 8 3 4 2 1 9 5 2
ISH-300	300x300 mm	294x294 mm	338x338 mm	252x268 mm	22 / 25 mm	 6 4 1 7 0 8 3 4 2 1 9 6 9
ISH-400	400x400 mm	394x394 mm	438x438 mm	352x368 mm	22 / 25 mm	 6 4 1 7 0 8 3 4 2 1 9 7 6
ISH-500	500x500 mm	494x494 mm	538x538 mm	452x468 mm	22 / 25 mm	 6 4 1 7 0 8 3 4 2 1 9 8 3
ISH-600	600x600 mm	594x594 mm	638x638 mm	552x568 mm	22 / 25 mm	 6 4 1 7 0 8 3 4 2 1 9 9 0

**FR30 PALOLUUKUT**  
**FR30 BRANDKLASSADE LUCKOR**  
**FR30 FIREPROOF ACCESS PANELS**

**seinään ja kattoon**  
**för vägg och tak**  
**for wall and ceiling**

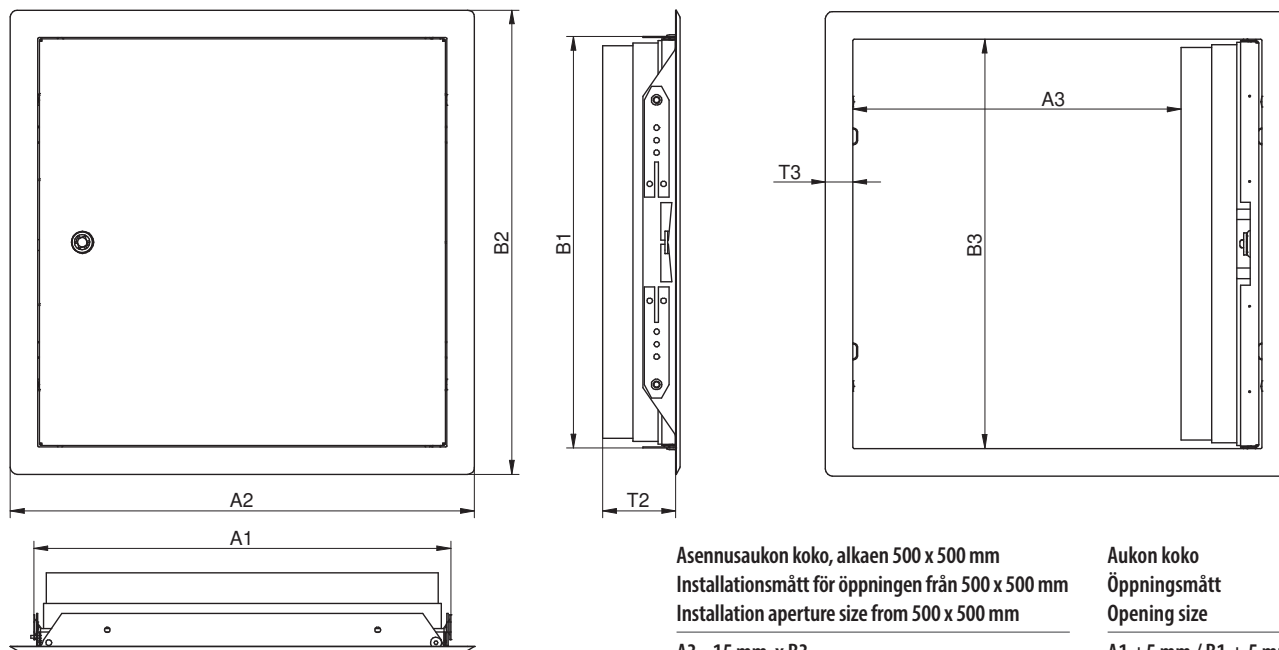

- EI30-paloluokitus
- Neliölukko (7 mm)
- Materiaali sinkitty teräs
- RAL9016 valkoinen polttomaalattu pinta. Muut RAL-sävyt saatavana tilauksesta
- Äänenvaimennus Rw 22 dB
- 400 x 400 mm ja suuremmat koot varustettu kahdella lukolla



- Brandklass EI30
- Fyrkantsslås (7 mm)
- Material galvaniserat stål
- RAL9016 vit emaljerad finish. Andra RAL-färger tillgängliga på beställning
- Ljudreduktion Rw 22 dB
- Utrustad med två lås från storlek 400 x 400 mm



- Fire resistance class EI30
- Square lock (7 mm)
- Material galvanized steel
- RAL9016 white baked enamel finish. Other RAL colours available on order
- Sound reduction Rw 22 dB
- Equipped with two locks from size 400 x 400 mm

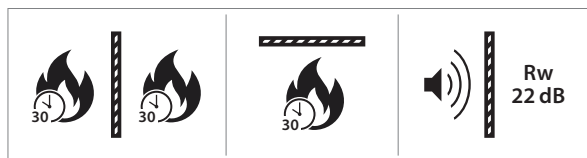

**MITTATILAUSTUOTTEET**

Koot 200x200 mm ▶ 600x600 mm, 50 mm välein



**MÅTTBESTÄLLDA PRODUKTER**

Storlekar 200x200 mm ▶ 600x600 mm, 50 mm steg





**CUSTOM-MADE PRODUCTS**

Sizes 200x200 mm ▶ 600x600 mm, 50 mm grid

**seinään ja kattoon**  
för vägg och tak  
for wall and ceiling

**FR30 PALOLUUKUT**  
FR30 BRANDKLASSADE LUCKOR  
FR30 FIREPROOF ACCESS PANELS

TUOTENRO PRODUKTNR PRODUCT NO	KOKO STORLEK SIZE	SISÄMITAT INNERMÅTT INNER DIMENSIONS A1 x B1	ULKOMITAT YTTERMÅTT OUTER DIMENSIONS A2 x B2	AUKKO ÖPPNING OPENING A3 x B3	SYVYYS / LEVEYS DJUP / BREDD DEPTH / WIDTH T2 / T3	EAN-KOODI EAN-KOD EAN-CODE
FR30-200	200x200 mm	200x200 mm	235x235 mm	135x195 mm	53 / 20 mm	 6 417 083 000614
FR30-300	300x300 mm	300x300 mm	335x335 mm	235x295 mm	53 / 20 mm	 6 417 083 000621
FR30-400	400x400 mm	400x400 mm	435x435 mm	335x395 mm	53 / 20 mm	 6 417 083 000638
FR30-500	500x500 mm	494x494 mm	538x538 mm	410x468 mm	53 / 25 mm	 6 417 083 000652
FR30-600	600x600 mm	594x594 mm	638x638 mm	510x568 mm	53 / 25 mm	 6 417 083 000669

-  **Asennusohje ja sertifikaatti**
-  **Installationsguide och certifikat**
-  **Installation guide and certificate**



# FR60 PALOLUUKUT

## FR60 BRANDKLASSADE LUCKOR

### FR60 FIREPROOF ACCESS PANELS

seinään ja kattoon

för vägg och tak

for wall and ceiling

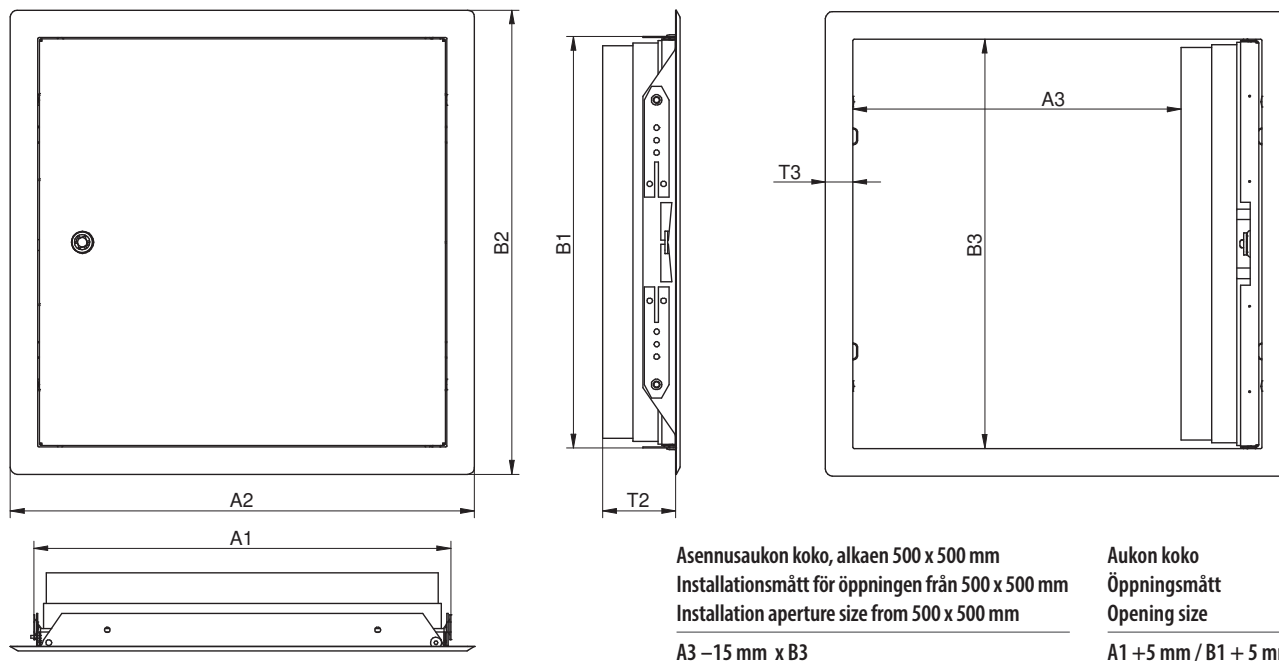

- EI60-paloluokitus pystyasennossa
- EI30-paloluokitus vaaka-asennossa
- Neliölukko (7 mm)
- Materiaali sinkitty teräs
- RAL9016 valkoinen polttomaalattu pinta. Muut RAL-sävyt saatavana tilauksesta
- Äänenvaimennus  $R_w$  22 dB
- 400 x 400 mm ja suuremmat koot varustettu kahdella lukolla



- Brandklass EI60 vid vertikal installation
- Brandklass EI30 vid horisontell installation
- Fyrkantslås (7 mm)
- Material galvaniserat stål
- RAL9016 vit emaljerad finish. Andra RAL-färger tillgängliga på beställning
- Ljudreduktion  $R_w$  22 dB
- Utrustad med två lås från storlek 400 x 400 mm



- Fire resistance class EI60 for vertically installed
- Fire resistance class EI30 for horizontally installed
- Square lock (7 mm)
- Material galvanized steel
- RAL9016 white baked enamel finish
- Sound reduction  $R_w$  22 dB
- Equipped with two locks from size 400 x 400 mm

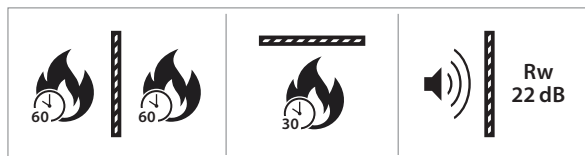

**seinään ja kattoon**  
för vägg och tak  
for wall and ceiling

**FR60 PALOLUUKUT**  
FR60 BRANDKLASSADE LUCKOR  
FR60 FIREPROOF ACCESS PANELS

TUOTENRO PRODUKTNR PRODUCT NO	KOKO STORLEK SIZE	SISÄMITAT INNERMÅTT INNER DIMENSIONS A1 x B1	ULKOMITAT YTTERMÅTT OUTER DIMENSIONS A2 x B2	AUKKO ÖPPNING OPENING A3 x B3	SYVYYS / LEVEYS DJUP / BREDD DEPTH / WIDTH T2 / T3	EAN-KOODI EAN-KOD EAN-CODE
FR60-200	200x200 mm	200x200 mm	235x235 mm	135x195 mm	53 / 20 mm	 6 4 1 7 0 8 3 1 0 0 0 6 7 6 1
FR60-300	300x300 mm	300x300 mm	335x335 mm	235x295 mm	53 / 20 mm	 6 4 1 7 0 8 3 1 0 0 0 6 8 3 1
FR60-400	400x400 mm	400x400 mm	435x435 mm	335x395 mm	53 / 20 mm	 6 4 1 7 0 8 3 1 0 0 0 6 9 0 1
FR60-500	500x500 mm	494x494 mm	538x538 mm	410x468 mm	53 / 25 mm	 6 4 1 7 0 8 3 1 0 0 0 8 3 6 1
FR60-600	600x600 mm	594x594 mm	638x638 mm	510x568 mm	53 / 25 mm	 6 4 1 7 0 8 3 1 0 0 0 8 4 3 1



**MITTATILAUSTUOTTEET**

Koot 200x200 mm ▶ 600x600 mm, 50 mm välein



**MÅTTBESTÄLLDA PRODUKTER**

Storlekar 200x200 mm ▶ 600x600 mm, 50 mm steg



**CUSTOM-MADE PRODUCTS**

Sizes 200x200 mm ▶ 600x600 mm, 50 mm grid



**Asennusohje ja sertifiikaatti**



**Installationsguide och certifikat**



**Installation guide and certificate**



**HSL PUSH-UP HUISSAUMALUUKUT**  
**HSL INSPEKTIONSLUCKOR MED TRYCKLÅSNING**  
**HSL ACCESS PANELS WITH PUSH LOCK**

**seinään ja kattoon**  
**för vägg och tak**  
**for wall and ceiling**

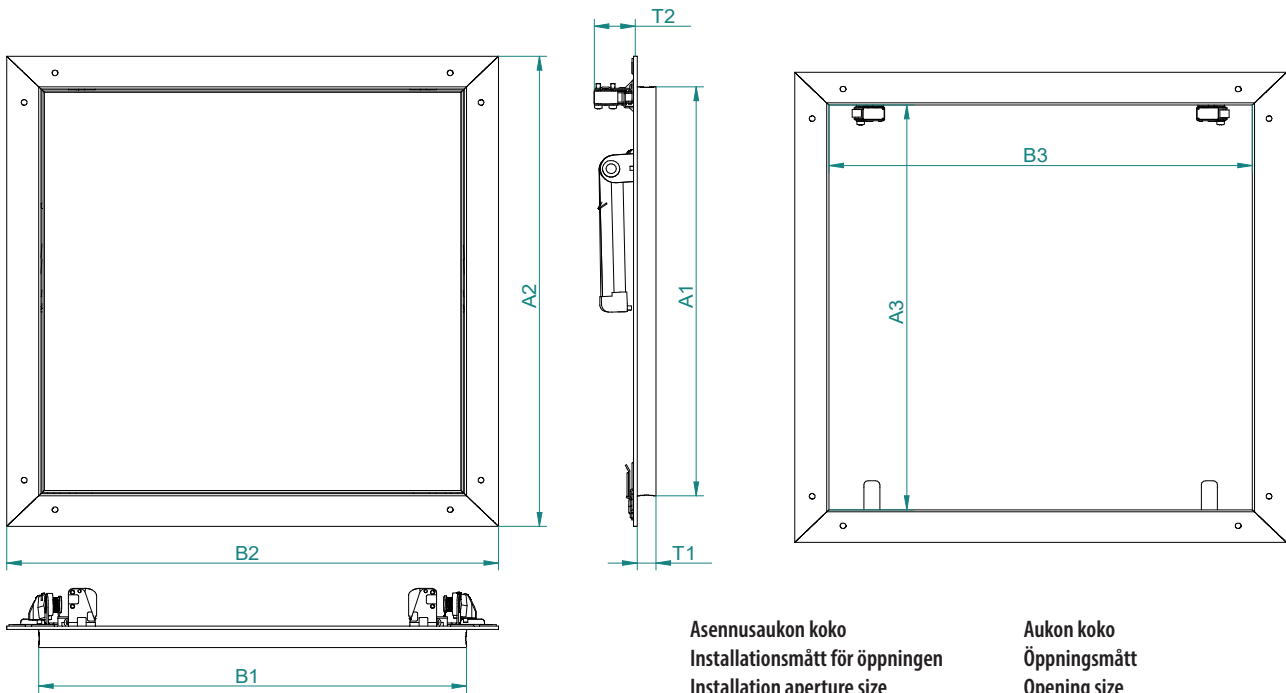

**Asennusaukon koko**  
**Installationsmått för öppningen**  
**Installation aperture size**

A3 –32 mm x B3

**Aukon koko**  
**Öppningsmått**  
**Opening size**

A1 +5 mm / B1 + 5 mm



- Alumiinirunko ja kipsilevykansi
- Push-up-lukitus
- Soveltuu märkätiloihin
- Kahdella kipsilevyllä varustetuissa HSL21-luukuissa näkyvät ruuvinkannat
- Päällimmäisen levyn voi vaihtaa seinäpintaan sopivaksi

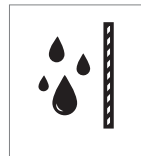

- Aluminiumram och inlägg av gipsskiva
- Trycklåsning
- Lämplig för våtrum
- HSL21-luckor med två gipsskivor har synliga skruvhuvuden
- Den översta skivan kan bytas ut så att den passar väggytan



- Aluminium frame with gypsum plasterboard inlay
- Push lock
- Suitable for wet rooms
- HSL21 access panels with two plasterboards have visible screwheads
- Top board can be replaced to fit the wall surface

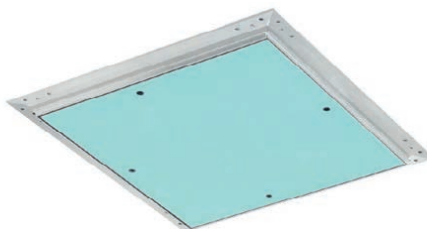

**MITTATILAUSTRUOTTEET**

Koot 150x150 mm ▶ 600x600 mm, 50 mm välein



**MÅTTBESTÄLLDA PRODUKTER**

Storlekar 150x150 mm ▶ 600x600 mm, 50 mm steg



**CUSTOM-MADE PRODUCTS**

Sizes 150x150 mm ▶ 600x600 mm, 50 mm grid

**seinään ja kattoon**  
för vägg och tak  
for wall and ceiling

**HSL PUSH-UP HIUSSAUMALUUKUT**  
HSL INSPEKTIONSLUCKOR MED TRYCKLÅSNING  
HSL ACCESS PANELS WITH PUSH LOCK

### 1 x 12,5 mm kipsilevyllä

Med 1 x 12,5 mm gipsskiva

With 1 x 12,5 mm gypsum plasterboard

TUOTENRO PRODUKTNR PRODUCT NO	KOKO STORLEK SIZE	SISÄMITAT INNERMÅTT INNER DIMENSIONS A1 x B1	ULKOMITAT YTTERMÅTT OUTER DIMENSIONS A2 x B2	AUKKO ÖPPNING OPENING A3 x B3	SYVYYS / LEVEYS DJUP / BREDD DEPTH / WIDTH T1 / T2	EAN-KOODI EAN-KOD EAN-CODE
HSL-200	200x200 mm	195x195 mm	239x239 mm	192x192 mm	13 / 30 mm	 6 417 083 017544
HSL-300	300x300 mm	295x295 mm	339x339 mm	292x292 mm	13 / 30 mm	 6 417 083 017551
HSL-400	400x400 mm	395x395 mm	439x439 mm	392x392 mm	13 / 30 mm	 6 417 083 017568
HSL-500	500x500 mm	495x495 mm	539x539 mm	492x492 mm	13 / 30 mm	 6 417 083 017575
HSL-600	600x600 mm	595x595 mm	639x639 mm	592x592 mm	13 / 30 mm	 6 417 083 017582

### 2 x 12,5 mm kipsilevyllä

Med 2 x 12,5 mm gipsskivor

With 2 x 12,5 mm gypsum plasterboards

TUOTENRO PRODUKTNR PRODUCT NO	KOKO STORLEK SIZE	SISÄMITAT INNERMÅTT INNER DIMENSIONS A1 x B1	ULKOMITAT YTTERMÅTT OUTER DIMENSIONS A2 x B2	AUKKO ÖPPNING OPENING A3 x B3	SYVYYS / LEVEYS DJUP / BREDD DEPTH / WIDTH T1 / T2	EAN-KOODI EAN-KOD EAN-CODE
HSL21-200	200x200 mm	195x195 mm	239x239 mm	192x192 mm	25,5 / 30 mm	 6 417 083 020872
HSL21-300	300x300 mm	295x295 mm	339x339 mm	292x292 mm	25,5 / 30 mm	 6 417 083 020889
HSL21-400	400x400 mm	395x395 mm	439x439 mm	392x392 mm	25,5 / 30 mm	 6 417 083 020896
HSL21-500	500x500 mm	495x495 mm	539x539 mm	492x492 mm	25,5 / 30 mm	 6 417 083 020902
HSL21-600	600x600 mm	595x595 mm	639x639 mm	592x592 mm	25,5 / 30 mm	 6 417 083 020919

**HSA ILMATIIVIIT HIUSSAUMALUUKUT**  
**HSA LUFTTÄTA INSPEKTIONSLUCKOR**  
**HSA AIRTIGHT ACCESS PANELS**

**seinään ja kattoon**  
**för vägg och tak**  
**for wall and ceiling**

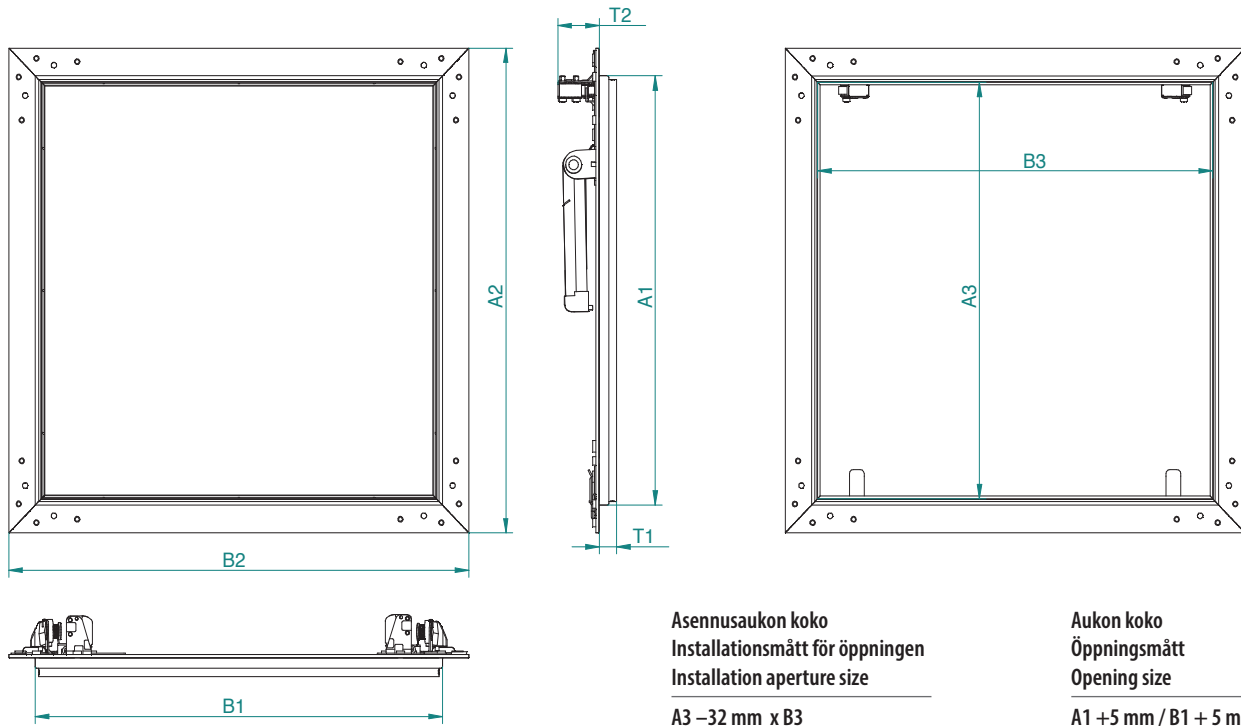

**Asennusaukon koko**  
**Installationsmått för öppningen**  
**Installation aperture size**  
**A3 – 32 mm x B3**

**Aukon koko**  
**Öppningsmått**  
**Opening size**  
**A1 + 5 mm / B1 + 5 mm**



- Alumiinirunko ja 12,5 mm kipsilevykansi
- Push-up-lukitus
- Ilma- ja pölytiivis
- Soveltuu märkätiloihin
- Äänenvaimennus Rw 29 dB

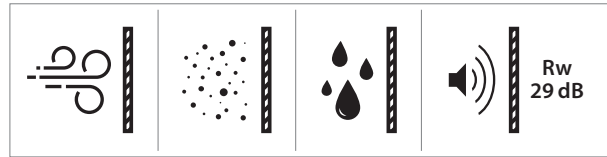

- Aluminiumram och inlägg av 12,5 mm gipsskiva
- Trycklåsning
- Luft- och dammtät
- Lämplig för våtrum
- Ljudreduktion Rw 29 dB

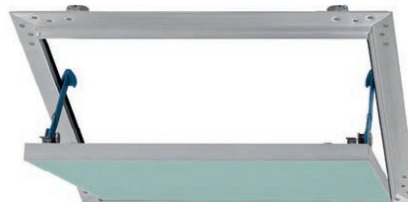

- Aluminium frame with 12,5 mm gypsum plasterboard inlay
- Push lock
- Air and dust-tight
- Suitable for wet rooms
- Sound reduction Rw 29 dB



**MITTATILAUSTUOTTEET**  
 Koot 150x150 mm ▶ 600x600 mm, 50 mm välein



**MÅTTBESTÄLLDA PRODUKTER**  
 Storlekar 150x150 mm ▶ 600x600 mm, 50 mm steg



**CUSTOM-MADE PRODUCTS**  
 Sizes 150x150 mm ▶ 600x600 mm, 50 mm grid

**seinään ja kattoon**  
**för vägg och tak**  
**for wall and ceiling**

**HSA ILMATIIVIIT HIUSSAUMALUUKUT**  
**HSA LUFTTÄTA INSPEKTIONSLUCKOR**  
**HSA AIRTIGHT ACCESS PANELS**

TUOTENRO PRODUKTNR PRODUCT NO	KOKO STORLEK SIZE	SISÄMITAT INNERMÅTT INNER DIMENSIONS A1 x B1	ULKOMITAT YTTERMÅTT OUTER DIMENSIONS A2 x B2	AUKKO ÖPPNING OPENING A3 x B3	SYVYYS / LEVEYS DJUP / BREDD DEPTH / WIDTH T1 / T2	EAN-KOODI EAN-KOD EAN-CODE
HSA-200	200x200 mm	201x201 mm	240x240 mm	192x192 mm	13 / 31 mm	 6 4 1 7 0 8 3 1 0 1 9 1 0 4
HSA-300	300x300 mm	301x301 mm	340x340 mm	292x292 mm	13 / 31 mm	 6 4 1 7 0 8 3 1 0 1 9 1 1 1
HSA-400	400x400 mm	401x401 mm	440x440 mm	392x392 mm	13 / 31 mm	 6 4 1 7 0 8 3 1 0 1 9 1 2 8
HSA-500	500x500 mm	501x501 mm	540x540 mm	492x492 mm	13 / 31 mm	 6 4 1 7 0 8 3 1 0 1 9 1 3 5
HSA-600	600x600 mm	601x601 mm	640x640 mm	592x592 mm	13 / 31 mm	 6 4 1 7 0 8 3 1 0 1 9 1 4 2

**HSF3 HIUSSAUMAPALOLUUKUT**  
**HSF3 BRANDKLASSADE INSPEKTIONSLUCKOR**  
**HSF3 FIREPROOF ACCESS PANELS**

**seinäasennuksiin**  
**för vägginstallationer**  
**for wall installations**

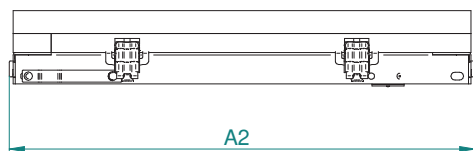
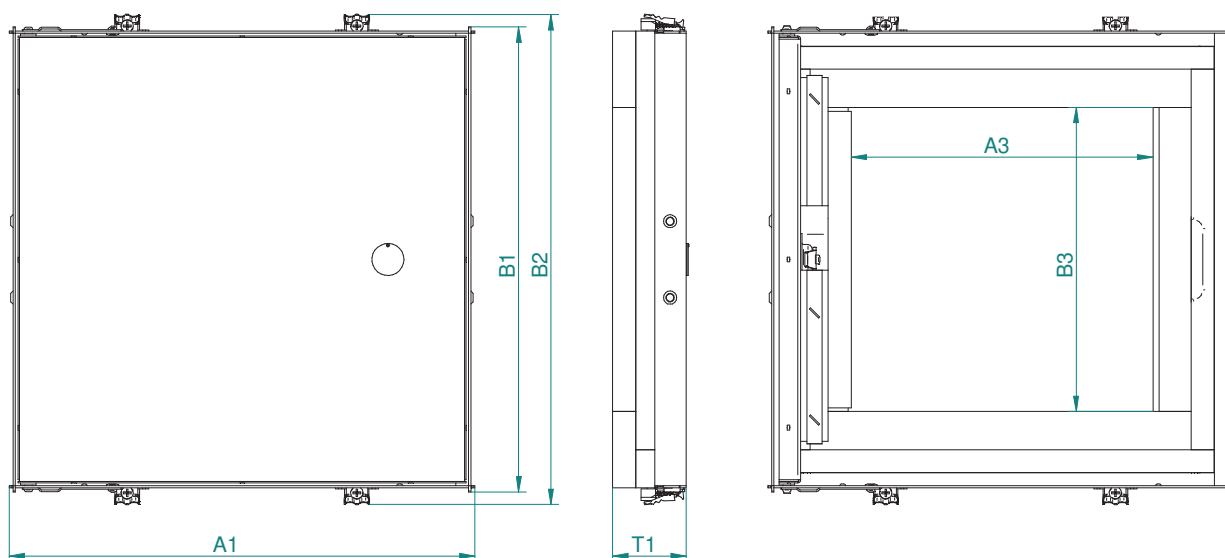

**Asennusaukon koko**  
**Installationsmått för öppningen**  
**Installation aperture size**

A3 x B3

**Aukon koko**  
**Öppningsmått**  
**Opening size**

(A1 + 10 mm) x (B1 + 30 mm)



- EI30-paloluokitus
- Savutiivis
- Neliölukko (7 mm)
- Materiaali sinkitty teräs ja kipsilevykansi
- Äänenvaimennus Rw 38 dB

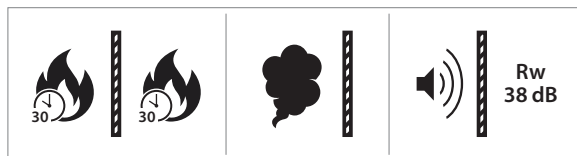

- Brandklass EI30
- Röktät
- Fyrkantslås (7 mm)
- Material galvaniserat stål och inlägg av gipsskiva
- Ljudreduktion Rw 38 dB



- Fire resistance class EI30
- Smoke-tight
- Square lock (7 mm)
- Material galvanized steel and gypsum plasterboard inlay
- Sound reduction Rw 38 dB



**MITTATILAUSTUOTTEET**

Koot 200x200 mm ▶ 600x1000 mm, 50 mm välein



**MÅTTBESTÄLLDA PRODUKTER**

Storlekar 200x200 mm ▶ 600x1000 mm, 50 mm steg











**CUSTOM-MADE PRODUCTS**

Sizes 200x200 mm ▶ 600x1000 mm, 50 mm grid

seinäasennuksiin  
för vägginstallationer  
for wall installations

HSF3 HIUSSAUMAPALOLUUKUT  
HSF3 BRANDKLASSADE INSPEKTIONSLUCKOR  
HSF3 FIREPROOF ACCESS PANELS

TUOTENRO PRODUKTNR PRODUCT NO	KOKO STORLEK SIZE	SISÄMITAT INNERMÅTT INNER DIMENSIONS A1 x B1	ULKOMITAT YTTERMÅTT OUTER DIMENSIONS A2 x B2	AUKKO ÖPPNING OPENING A3 x B3	SYVYYS DJUP DEPTH T1	EAN-KOODI EAN-KOD EAN-CODE
HSF3-300	300x300 mm	304x304 mm	304x322 mm	197x199 mm	48 mm	 6 4 1 7 0 8 3 1 0 1 9 2 5 8
HSF3-400	400x400 mm	404x404 mm	404x422 mm	297x299 mm	48 mm	 6 4 1 7 0 8 3 1 0 1 9 2 6 5
HSF3-500	500x500 mm	504x504 mm	504x522 mm	397x399 mm	48 mm	 6 4 1 7 0 8 3 1 0 1 9 2 7 2
HSF3-600	600x600 mm	604x604 mm	604x622 mm	497x499 mm	48 mm	 6 4 1 7 0 8 3 1 0 1 9 2 8 9
HSF3-6080	600x800 mm	604x804 mm	604x822 mm	497x699 mm	48 mm	 6 4 1 7 0 8 3 1 0 1 9 2 9 6
HSF3-6010	600x1000 mm	604x1004 mm	604x1022 mm	497x899 mm	48 mm	 6 4 1 7 0 8 3 1 0 1 9 3 0 2

-  Asennusohje ja sertifikaatti
-  Installationsguide och certifikat
-  Installation guide and certificate



**CHF3 HIUSSAUMAPALOLUUKUT**  
**CHF3 BRANDKLASSADE INSPEKTIONSLUCKOR**  
**CHF3 FIREPROOF ACCESS PANELS**

**kattoasennuksiin**  
**för takinstallationer**  
**for ceiling installations**

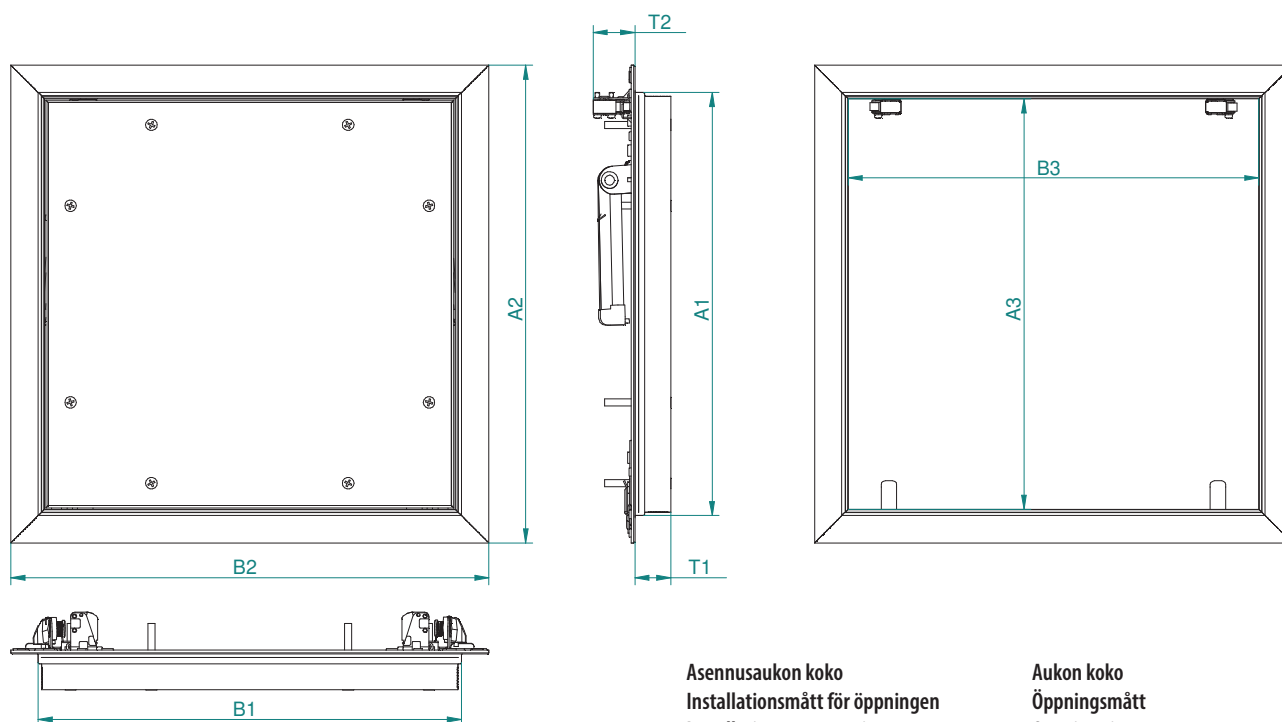

**Asennusaukon koko**  
**Installationsmått för öppningen**  
**Installation aperture size**

A3 –34 mm x B3

**Aukon koko**  
**Öppningsmått**  
**Opening size**

A1 +5 mm / B1 +5 mm



- EI30-paloluokitus
- Alumiinirunko ja kaksi 12,5 mm kipsilevyä
- Push-up-lukitus



- Brandklass EI30
- Aluminiumram och två 12,5 mm gipsskivor
- Trycklåsning



- Fire resistance class EI30
- Aluminium frame with two 12,5 mm gypsum plasterboards
- Push lock



**MITTATILAUSTUOTTEET**

Koot 200x200 mm ▶ 600x1200 mm, 10 mm välein



**MÅTTBESTÄLLDA PRODUKTER**

Storlekar 200x200 mm ▶ 600x1200 mm, 10 mm steg





**CUSTOM-MADE PRODUCTS**

Sizes 200x200 mm ▶ 600x1200 mm, 10 mm grid

**kattoasennuksiin**  
för takinstallationer  
for ceiling installations

**CHF3 HIUSSAUMAPALOLUUKUT**  
CHF3 BRANDKLASSADE INSPEKTIONSLUCKOR  
CHF3 FIREPROOF ACCESS PANELS

TUOTENRO PRODUKTNR PRODUCT NO	KOKO STORLEK SIZE	SISÄMITAT INNERMÅTT INNER DIMENSIONS A1 x B1	ULKOMITAT YTTERMÅTT OUTER DIMENSIONS A2 x B2	AUKKO ÖPPNING OPENING A3 x B3	SYVYYS / LEVEYS DJUP / BREDD DEPTH / WIDTH T1 / T2	EAN-KOODI EAN-KOD EAN-CODE
CHF3-200	200x200 mm	197x197 mm	239x239 mm	189x189 mm	26 / 41 mm	 6 417 083 023743
CHF3-300	300x300 mm	297x297 mm	339x339 mm	289x289 mm	26 / 41 mm	 6 417 083 023750
CHF3-400	400x400 mm	397x397 mm	439x439 mm	389x389 mm	26 / 41 mm	 6 417 083 023767
CHF3-500	500x500 mm	497x497 mm	539x539 mm	489x489 mm	26 / 41 mm	 6 417 083 023774
CHF3-600	600x600 mm	597x597 mm	639x639 mm	589x589 mm	26 / 41 mm	 6 417 083 023781





-  **Asennusohje ja sertifikaatti**
-  **Installationsguide och certifikat**
-  **Installation guide and certificate**



**PEITELEVYT**  
**TÄCKSKIVOR**  
COVER PLATES

**seinään ja kattoon**  
**för vägg och tak**  
for wall and ceiling

Peitelevy kiinnitysreiällä | Täckskira med fästhål  
Cover plate with mounting holes

TUOTENRO PRODUKTNR PRODUCT NO	KOKO STORLEK SIZE	AUKKO MAX. ÖPPNING MAX. OPENING MAX.	EAN-KOODI EAN-KOD EAN-CODE
PL-90	150x150 mm	90x90 mm	 6 417 083 018 763
PL-140	200x200 mm	140x140 mm	 6 417 083 010 613
PL-200	260x260 mm	200x200 mm	 6 417 083 010 620
PL-300	360x360 mm	300x300 mm	 6 417 083 010 637
PL-400	460x460 mm	400x400 mm	 6 417 083 010 644
PL-500	560x560 mm	500x500 mm	 6 417 083 010 651



- RAL9016 valkoinen jauhemaalattu teräs. Muut RAL-sävyt saatavana tilauksesta
- Reikien halkaisija 4 mm
- Sisäkäyttöön



- Pulverlackerat stål RAL9016 vit. Andra RAL-färger tillgängliga på beställning
- Fästhålens diameter 4 mm
- För inomhusbruk



- Powder coated steel RAL 9016 white. Other RAL colours available on order
- Mounting hole diameter 4 mm
- For indoor use



Peitelevy reiätön | Täckskira utan fästhål  
Cover plate without holes

TUOTENRO PRODUKTNR PRODUCT NO	KOKO STORLEK SIZE	AUKKO MAX. ÖPPNING MAX. OPENING MAX.	EAN-KOODI EAN-KOD EAN-CODE
PL-90-R	150x150 mm	90x90 mm	 6 417 083 031 243
PL-140-R	200x200 mm	140x140 mm	 6 417 083 031 199
PL-200-R	260x260 mm	200x200 mm	 6 417 083 031 205
PL-300-R	360x360 mm	300x300 mm	 6 417 083 031 212
PL-400-R	460x460 mm	400x400 mm	 6 417 083 031 229
PL-500-R	560x560 mm	500x500 mm	 6 417 083 031 236



- RAL9016 valkoinen jauhemaalattu teräs. Muut RAL-sävyt saatavana tilauksesta
- Sisäkäyttöön



- Pulverlackerat stål RAL9016 vit. Andra RAL-färger tillgängliga på beställning
- För inomhusbruk





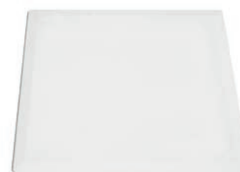



- Powder coated steel RAL 9016 white. Other RAL colours available on order
- For indoor use



**seinään ja kattoon**  
för vägg och tak  
for wall and ceiling

**PEITELEVYT**  
**TÄCKSKIVOR**  
COVER PLATES

Peitelevy magneeteilla   Täckskira med magneter Cover plate with magnets			
TUOTENRO PRODUKTNR PRODUCT NO	KOKO STORLEK SIZE	AUKKO MAX. ÖPPNING MAX. OPENING MAX.	EAN-KOODI EAN-KOD EAN-CODE
PL-90 MG	150x150 mm	90x90 mm	 6 4 17083 032684
PL-140 MG	200x200 mm	140x140 mm	 6 4 17083 032691
PL-200 MG	260x260 mm	200x200 mm	 6 4 17083 032707
PL-300 MG	360x360 mm	300x300 mm	 6 4 17083 032714
PL-400 MG	460x460 mm	400x400 mm	 6 4 17083 032721
PL-500 MG	560x560 mm	500x500 mm	 6 4 17083 032738



- RAL9016 valkoinen jauhemaalattu teräs
- Sisältää tarvittavan määrän magneetteja
- Soveltuu kaikille sileille ja puhtaille pinnoille
- PL-400 MG ja PL-500 MG kattoasennuksiin suositellaan putoamissuojaa PLPS-300
- Sisäkäyttöön



- Pulverlackerat stål RAL9016 vit
- Innehåller erforderligt antal magneter
- Lämplig för alla släta och rena ytor
- För takmontering av PL-400 MG och PL-500 MG rekommenderas fallskydd PLPS-300
- För inomhusbruk



- Powder coated steel RAL 9016 white
- Includes required number of magnets
- Suitable for all smooth, clean surfaces
- For ceiling installations of PL-400 MG and PL-500 MG, fall protection kit PLPS-300 is recommended
- For indoor use

**TARVIKKEET**  
**TILLBEHÖR**  
ACCESSORIES

Magneettipakkaus, 4 kpl   Magnetpaket, 4 st   Magnet package, 4 pcs   2x20 mm	
TUOTENRO   PRODUKTNR   PRODUCT NO	EAN-KOODI   EAN-KOD   EAN-CODE
MG202	 6 4 17083 024900
Peitelevyn putoamissuoja   Fallskydd för täckskira Fall protection kit for cover plate   300 mm	
PLPS-300	 6 4 17083 028601





Neliöavain, teräs   Fyrkantsnyckel, stål   Square pin key, steel   7 mm	
TUOTENRO   PRODUKTNR   PRODUCT NO	EAN-KOODI   EAN-KOD   EAN-CODE
KEYPL	 6 4 17083 001062

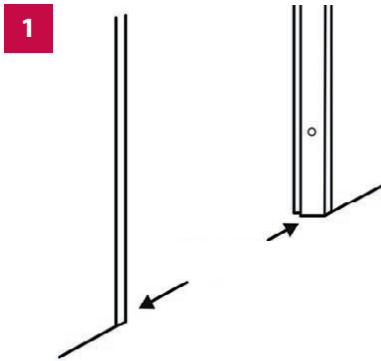



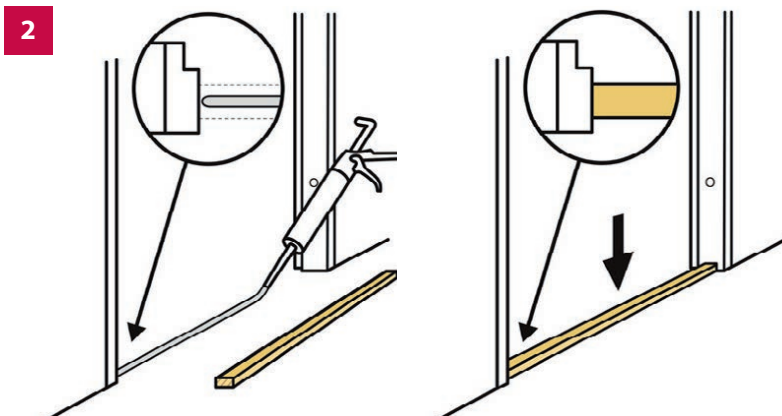

1

-  Valitse oikea pituus oven karmien välimittan mukaisesti. Tarvittaessa RST-kynnystä voi lyhentää 0,8 mm RST-katkaisulaikalla. Alusvanerin voi lyhentää sahalla tai katkaisusirkkelillä.
-  Välj rätt längd i enlighet med mellanmättet för dörrens karmar. Vid behov kan den rostfria listan dock förkortas 0,8 mm med en kapskiva för rostfritt stål. Underlaget av faner kan förkortas med såg eller kapningscirkel.
-  Choose the right length according to the intermediate measurement of the door frames. If necessary, the stainless steel list can be shortened with a 0.8 mm stainless steel cutting blade. The base plywood can be shortened with a saw or a mitre saw.



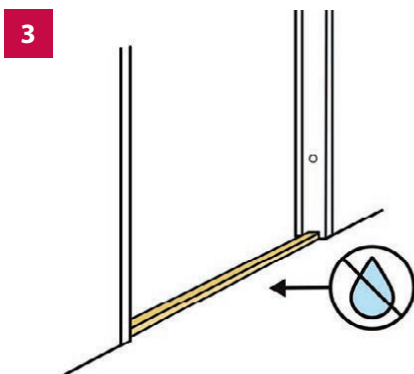

2

-  Liimaa vanerisoiro oven karmien väliin kohtaan, jossa ei ole huullostaa.
-  Limma fanerlisten emellan karmarna på ett ställe utan fals.
-  Glue the plywood batten between the door frames, in a place where there is no rabbet.



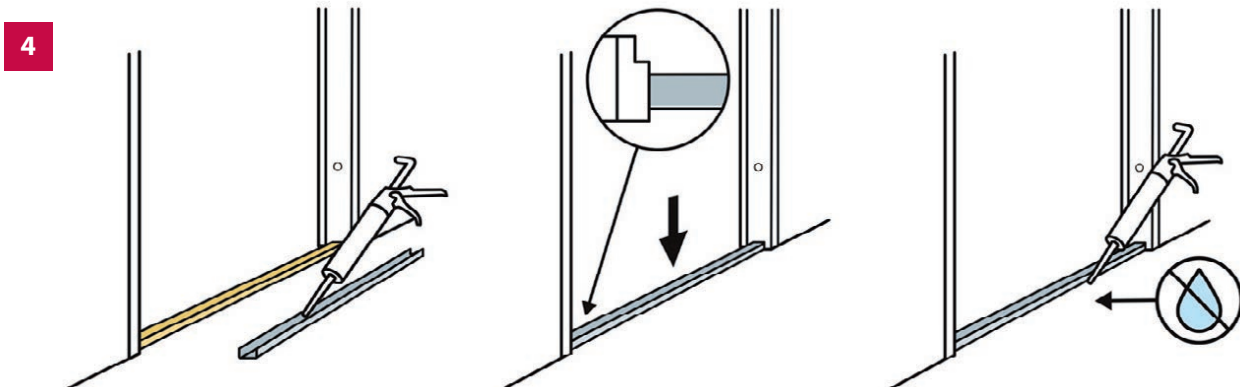

3

-  Lattian vesieristystyön yhteydessä vesieriste levitetään tiiviisti vanerisoiron etureunaan ja yläpuolelle.
-  I samband med golvetts vattenisoleringsarbete bredds vattenisoleringen tätt till framkanten av fanerlisten och ovanför listen.
-  During the waterproofing of the floor, the waterproofing material is spread tightly to the front edge and on top of the plywood batten.



4

-  Pintalista liimataan vesieristettyyn vanerisoiron laatoituksen yhteydessä.
-  Ytlisten limmas till den vattenisolerade fanerlisten i samband med läggningen av plattor.
-  The cover list is glued on the water-proofed plywood batten during the tiling work.

**kynnys ennen karmeja**  
tröskel före karmarna  
threshold before door frame

**ASENNUSOHJEET**  
**MONTERINGSANVISNINGAR**  
INSTALLATION INSTRUCTIONS

1

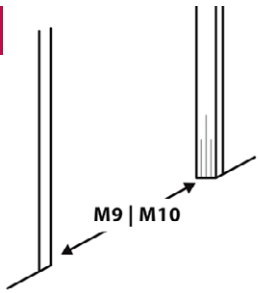

Valitse oikea pituus suunnitellun oven karmien välimitan mukaisesti. Kynnyksen pituus on mitoitettu optimaalisesti M9 tai M10 oviaukoille, jolloin kynnykslistaa ei tarvitse lyhentää tai loveta (tarvittaessa RST-listaa voi kuitenkin lyhentää 0,8 mm RST-katkaisulaikalla).



Välj rätt längd i enlighet med mellanmåtten för den planerade dörrrens karmar. Tröskelns längd är optimalt dimensionerad för M9 eller M10 dörröppningar, varvid tröskellisten inte behöver förkortas eller slitas.



Choose the right length according to the intermediate measurement of the door frames. The length of the threshold has been optimally dimensioned for M9 or M10 doorways, so that the threshold list does not have to be shortened or notched.

2

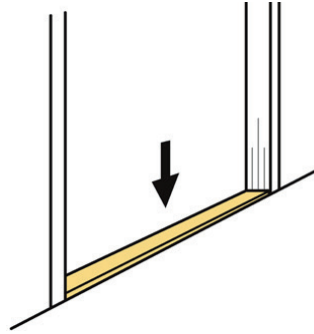
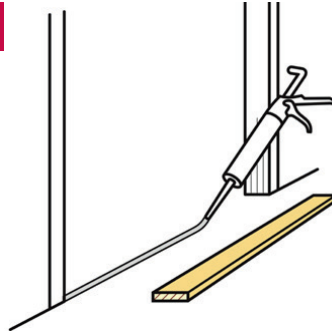

Liimaa vanerisoiro oviaukon väliin ennen oven karmien asennusta.



Limma fanerlisten till dörröppningen innan du monterar karmarna.



Glue the plywood batten in the doorway, before the installation of the frames.

3

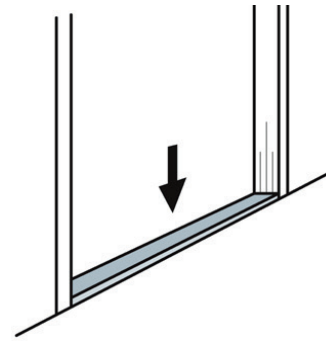
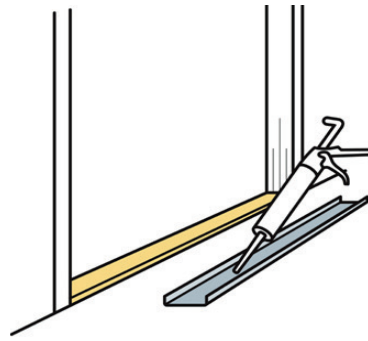
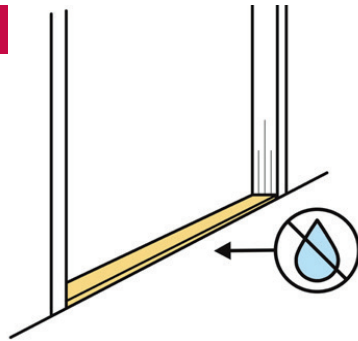

Lattian vesieristystyön yhteydessä vesieriste levitetään tiiviisti vanerisoiron etureunaan ja yläpuolelle.



Vid golvets vattenisolerings dras vattenisoleringsen tätt mot fanerlistens framkant och över listen.



During floor waterproofing, apply waterproofing tightly to the front edge and over the plywood batten.



Pintalista liimataan vesieristettyyn vanerisoiron ennen ovenkarmien asennusta.



Ytlisten limmas till den vattenisolerade fanerlisten före monteringen av dörrkarmarna.



The cover list is glued on the water-proofed plywood batten before the installation of the door frames.

4

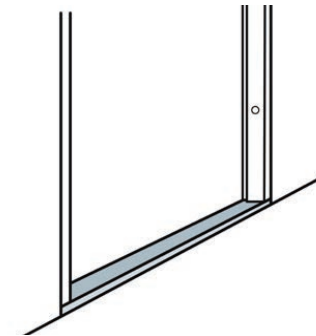
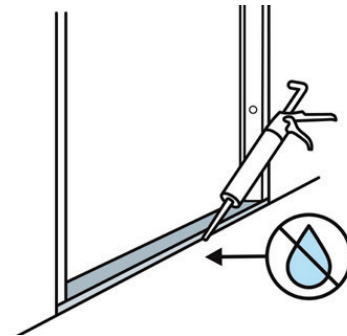
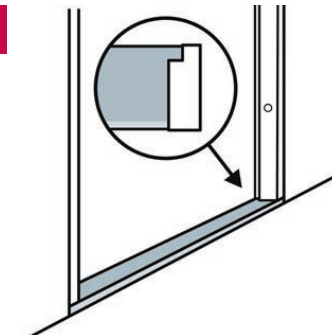

Ovenkarmien pää asennetaan kynnyksen päälle. Asennettaessa on huomioitava, että kynnyksen korkeus nostaa ovenkarmien ja oven kohtaa 20 mm.



Dörrkarmarnas ändor monteras ovanpå tröskeln. Vid monteringen ska observeras, att tröskelns höjd lyfter dörrkarmarna och dörren med 20 mm.



The top of the door frames is installed onto the threshold. During the installation process, it must be taken into consideration that the height of the threshold will raise the height of the door frames and the door by 20 mm.

# LAATTALISTOJEN ASENNUSOHJEET

## MONTERINGSANVISNINGAR FÖR KAKELLISTER

### INSTALLATION INSTRUCTIONS FOR TILE TRIMS

 Laattalista valitaan laatan paksuuden ja värin mukaan. Laattalistan H-mitta kertoo laatan maksimikorkeuden. Laattalistat suojaavat laattojen ulkoreunoja ja piilottavat rappaussauaman luoden samalla siistin ja huolitellun ilmeen. Laattalistojen käyttö tekee laatoituksesta myös helpompaa ja nopeampaa.

Laattalistat asennetaan laastiin laatoituksen aikana. Laatoita ensin yksi seinä ja asenna sitten laattalista kiinnityslaastiin. Laatoita seinä niin, että listan reuna on samalla tasolla kuin laattojen reunat. Saumaa laatoitus, ja ulkonurkka on valmis.

**Laattalialle jäävä ylimääräinen saumauslaasti tulee pestä pois välittömästi, koska se on vahvasti syövyttävää.**

 Kakellister skyddar kaklets ytterhörn och döljer kanten med häftmassa samtidigt som de ger ett rent och fint utseende. Dessutom går själva kakelsättningen enklare och snabbare med kakellister.

Kakla först en vägg och montera listan i fästmassan. Kakla väggen så att listans kant är på samma nivå som kaklet. Avsluta genom att täta ytterhörnet.

**Överflödigt tätningsmassa ska torkas bort omedelbart från kakellisten eftersom den är mycket frätande.**

 Tile trims protect the outer corners of the tiling and conceal the clay edge while simultaneously giving a clean, polished look. Using tile trims also makes tiling easier and quicker.

First tile one wall and then install the tile trim to the mortar. Tile the wall so that the edge of the trim is at the same level as the tiles. Seal the tiling to complete the outer corner.

**The extra sealing material must be washed off immediately of the tiletrim as it is highly corrosive.**



 Laattalistojen asennus



 Montering av kakellister



 Lattialistojen asennus



 Installering av golvprofiler



 Dione-profile installation

# LATTIALISTOJEN ASENNUSOHJEET

## MONTERINGSANVISNINGAR FÖR GOLVPROFILER

### INSTALLATION INSTRUCTIONS FOR FLOORING PROFILES



**LIIMA** Levitä kiinnitysiima puhtaalle, ei-huokoiselle pinnalle ja paina lista paikalleen. Katso ohjeet liimatuubista.

**LIM** Fixeringslimmet appliceras på en ren, ickeporös yta och profilen pressas på plats. Se anvisningar på förpackning.

**GLUE** Fixing glue is applied on a clean, non-porous surface and the profile is pressed into place. See instructions on packaging.



**RUUVIT** ovat perinteikkään asennusmenetelmä. Ruuveilla kiinnitettävät Dione-listat myydään ruuveineen saumattoman istuvuuden varmistamiseksi.

**SKRUVAR** är det mest traditionella monteringsättet. Dione-profiler med skruvmontering, pakteras med matchande skruvar för perfekt passning.

**SCREWS** are the most traditional installation method. Screw-adhesive Dione profiles are packed with matching screws to ensure a perfect fit.



**ELASTICFIX**-kiinnitteisten saumalistojen asentaminen on nopeaa ja helppoa: leikkaat vain listan oikean mittaiseksi, poistat suoja-ääilyksen ja kiinnität listan paikalleen.

**ELASTICFIX** Att montera profiler med Elasticfix går snabbt och enkelt: kapa bara profilen till lämplig storlek, ta bort skyddsmaterialet och sätt profilen på plats.

**ELASTICFIX FASTENING** Installing profiles with Elasticfix fastening is quick and easy: just cut the profile to size, remove the protective cover and press the profile in its place. ensure a perfect fit.



**NAULATULPPA** Tulppakiinnitystä varten liikuntasamaan porataan suoralle akselille 5 mm:n reiät. Metalliset tulpat liu'utetaan tämän jälkeen listan keskiuraan.

**SPIKPLUGGAR** När spikpluggar används borras 5 mm hål i rörelsefog i en rak linje. Metallspikar skjuts sedan in i listans mittspår.

**NAIL PLUG SYSTEM** To install the nail plug system 5 mm holes are drilled into the movement joint in a straight line. Metallic nails are then slid into the middle groove of the trim.

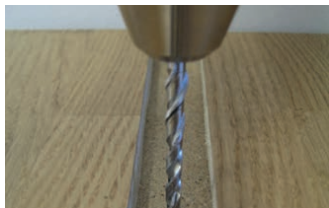

**ALAKISKOKIIINNITYS** Alakiskokiinnityksiä asennettaessa erillinen kisko asennetaan ensin lattiaan ruuveilla tai liimalla samanaikaisesti lattiamateriaalin kanssa. Ylempi kappale kiinnitetään lattian asennuksen jälkeen.

**SKENOR** Vid montering med skenor fixeras först den separata skenan i golvet med skruvar eller lim samtidigt med golvmaterial. Topplisten fästs efter att golvet har lagts.

**UNDERRAIL** When installing underrail profiles the separate under rail is first fixed into the floor with screws or glue simultaneously with the flooring material. The top strip is attached after the flooring has been installed.

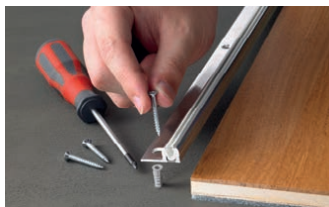

# HAKEMISTO

## FÖRTECKNING

### INDEX

TUOTENRO PRODUKTNR PRODUCT NO	SIVU SIDA PAGE	TUOTENRO PRODUKTNR PRODUCT NO	SIVU SIDA PAGE	TUOTENRO PRODUKTNR PRODUCT NO	SIVU SIDA PAGE	TUOTENRO PRODUKTNR PRODUCT NO	SIVU SIDA PAGE
2B BL 269.....	256	904 TA 180.....	69	6535-BLR.....	174	6561-BLACK.....	186
2B SI 269.....	260	925 TA 90.....	21	6535-CBL.....	174	6561-BLR.....	186
2D BL 424.....	258	925 TA 180.....	21	6535-GRR.....	174	6561-CBL.....	186
2D SI 424.....	262	1010-HARMAA.....	209	6535-HE.....	174	6561-GRR.....	186
6B BL 269.....	257	1010-HARMAA RULLA.....	209	6535-HST.....	175	6561-HE.....	186
6B SI 269.....	261	1011.....	209	6535-IC.....	176	6561-MUR.....	186
6D BL 424.....	259	6208-RST.....	206	6535-MGR.....	174	6561-NG.....	186
6D SI 424.....	263	6208-RST HI.....	206	6535-MUR.....	174	6561-SAR.....	186
8B BL 269.....	257	6510-BEIGE.....	189	6535-NG.....	174	6561-SILVER.....	186
8B SI 269.....	261	6510-BROKEN WHITE.....	189	6535-OC.....	177	6561-TITAN.....	186
8D BL 424.....	259	6510-GREY.....	189	6535-RST.....	175	6561-WHITE.....	186
8D SI 424.....	263	6510-LIGHT GREY.....	189	6535-RST BL.....	175	6561-WSR.....	186
10B BL 269.....	256	6510-WHITE.....	189	6535-RST CU.....	175	6570-BLACK.....	182
10B SI 269.....	260	6515-BEIGE.....	189	6535-RST HI.....	175	6570-BLR.....	182
10D BL 424.....	258	6515-BLACK.....	189	6535-RST MS.....	175	6570-CBL.....	182
10D SI 424.....	262	6515-BROKEN WHITE.....	189	6535-SAR.....	174	6570-GRR.....	182
18B BL 269.....	256	6515-GREY.....	189	6535-SILVER.....	174	6570-HE.....	182
18B SI 269.....	260	6515-LIGHT GREY.....	189	6535-TITAN.....	174	6570-HST.....	183
18D BL 424.....	258	6515-WHITE.....	189	6535-WHITE.....	174	6570-IC.....	184
18D SI 424.....	262	6516-WHITE.....	190	6535-WSR.....	174	6570-MUR.....	182
20B BL 269.....	256	6520-BEIGE.....	190	6541-BLACK.....	171	6570-NG.....	182
20B SI 269.....	260	6520-BLACK.....	190	6541-BLR.....	171	6570-OC.....	185
20D BL 424.....	258	6520-BROKEN WHITE.....	190	6541-CBL.....	171	6570-RST.....	183
20D SI 424.....	262	6520-GREY.....	190	6541-GRR.....	171	6570-SAR.....	182
22B BL 269.....	257	6520-LIGHT GREY.....	190	6541-HE.....	171	6570-SILVER.....	182
22B SI 269.....	261	6520-WHITE.....	190	6541-MUR.....	171	6570-TITAN.....	182
22D BL 424.....	259	6521-WHITE.....	191	6541-NG.....	171	6570-WHITE.....	182
22D SI 424.....	263	6525-BEIGE.....	191	6541-SAR.....	171	6570-WSR.....	182
34B BL 269.....	256	6525-BLACK.....	191	6541-SILVER.....	171	6575-NG.....	188
34B SI 269.....	260	6525-BROKEN WHITE.....	191	6541-TITAN.....	171	6580-RST.....	201
34D BL 424.....	258	6525-GREY.....	191	6541-WHITE.....	171	6590-BEIGE.....	202
34D SI 424.....	262	6525-LIGHT GREY.....	191	6541-WSR.....	171	6590-BLACK.....	202
36B BL 269.....	257	6525-WHITE.....	191	6550.....	170	6590-HARMAA.....	202
36B SI 269.....	261	6530-HE.....	164	6550-C.....	172	14615.....	53
36D BL 424.....	259	6530-RST.....	164	6550-HST.....	170	14625.....	53
36D SI 424.....	263	6530-SILVER.....	164	6550-RST BL.....	170	14715.....	54
55B BL 269.....	257	6530-WHITE.....	164	6550-RST CU.....	170	14725.....	54
55B SI 269.....	261	6531-BLACK.....	165	6550-RST MS.....	170	30610.....	124
55D BL 424.....	259	6531-HE.....	165	6551-BLACK.....	178	30615.....	124
55D SI 424.....	263	6531-NG.....	165	6551-BLR.....	178	65210.....	201
64B BL 269.....	257	6531-WHITE.....	165	6551-CBL.....	178	65353-RST.....	175
64B SI 269.....	261	6534-BLR.....	166	6551-GRR.....	178	65553.....	179
64D BL 424.....	259	6534-CBL.....	166	6551-HE.....	178	70474.....	122
64D SI 424.....	263	6534-GRR.....	166	6551-MGR.....	178	70475.....	122
73B BL 269.....	257	6534-HE.....	166	6551-MUR.....	178	70476.....	122
73B SI 269.....	261	6534-HST.....	167	6551-NG.....	178	77023.....	121
73D BL 424.....	259	6534-IC.....	168	6551-SAR.....	178	77025.....	121
73D SI 424.....	263	6534-MUR.....	166	6551-SILVER.....	178	77027.....	121
100B BL 269.....	256	6534-NG.....	166	6551-TITAN.....	178	77030.....	121
100B SI 269.....	260	6534-OC.....	169	6551-WHITE.....	178	77050.....	121
100D BL 424.....	258	6534-RST.....	167	6551-WSR.....	178	77051.....	121
100D SI 424.....	262	6534-RST BL.....	167	6555.....	179	77056.....	121
559-125 SINIHARMAA.....	206	6534-RST CU.....	167	6555-C.....	180	77057.....	121
559-125 VALKOINEN.....	206	6534-RST MS.....	167	6555-HST.....	179	77060.....	121
559-SINIHARM.....	206	6534-SAR.....	166	6555-RST BL.....	179	740103.....	292
559-VALK.....	206	6534-SILVER.....	166	6555-RST CU.....	179	7090401.....	62
904 PH 90.....	69	6534-TITAN.....	166	6555-RST MS.....	179	7090404-R.....	64
904 PH 180.....	69	6534-WHITE.....	166	6560.....	187	7090405-R.....	64
904 PY 180.....	69	6534-WSR.....	166	6560-C.....	188	7090905-R.....	73
904 TA 90.....	69	6535-BLACK.....	174	6560-HST.....	187	7091004-R.....	38

# HAKEMISTO FÖRTECKNING INDEX

TUOTENRO PRODUKTNR PRODUCT NO	SIVU SIDA PAGE	TUOTENRO PRODUKTNR PRODUCT NO	SIVU SIDA PAGE	TUOTENRO PRODUKTNR PRODUCT NO	SIVU SIDA PAGE	TUOTENRO PRODUKTNR PRODUCT NO	SIVU SIDA PAGE
7091005-R.....	38	7303032.....	151	A2 M1.....	9	A5 PE1.....	30
7091105-R.....	40	7303034.....	153	A2 M2.....	9	A5 PE2.....	30
7091601-W.....	54	7311135.....	155	A2 M3.....	9	A5 PE3.....	30
7092201.....	59	7324501.....	103	A2 M 90.....	9	A5 PH1-R.....	31
7092205.....	59	7324501-R.....	103	A2 M 180.....	9	A5 PH2-R.....	31
7092601-R.....	89	7324503.....	103	A2 PE1.....	8	A5 PH3-R.....	31
7092701.....	114	7324506.....	103	A2 PE2.....	8	A5 PY 180-R.....	31
7092901.....	72	7333032.....	148	A2 PE3.....	8	A5 PY 270-R.....	31
7092904.....	72	7333034.....	149	A3 A1.....	22	A5 RST 1-R.....	28
7093005-R.....	9	7352505-R.....	104	A3 A2.....	22	A5 RST 2-R.....	28
7093201.....	110	7352605-R.....	105	A3 A3.....	22	A5 TA1-R.....	31
7093203.....	110	7352705-R.....	114	A3 A 90.....	22	A5 TA2-R.....	31
7093203-GLOW.....	110	7352805-R.....	119	A3 BL1.....	22	A5 TA3-R.....	31
7093204.....	110	7433032.....	148	A3 BL2.....	22	A6 NG1-R.....	36
7093204-001.....	120	7523101.....	112	A3 BL3.....	22	A6 NG2-R.....	36
7093204-005.....	120	7523101-R.....	113	A3 HE1.....	22	A6 PH 90-R.....	37
7093301.....	119	7523104.....	112	A3 HE2.....	22	A6 PH 180-R.....	37
7093301-1.....	120	7523106-R.....	113	A3 HE3.....	22	A6 PH 270-R.....	37
7094301.....	91	7523109-R.....	113	A3 KE1.....	22	A6 RST 1-R.....	36
7094404.....	27	7523501.....	93	A3 KE2.....	22	A6 RST 2-R.....	36
7094405.....	27	7523503-R.....	93	A3 KE3.....	22	A6 TA1-R.....	37
7094405-R.....	27	7523601.....	90	A3 KR1.....	23	A6 TA2-R.....	37
7094504.....	25	7555001.....	117	A3 KR2.....	23	A6 TA3-R.....	37
7094505-R.....	27	7555001 GLOW.....	117	A3 KR3.....	23	A7 HE1-R.....	39
7094605-R.....	9	7564702.....	118	A3 KR 180.....	23	A7 HE2-R.....	39
7094703-R.....	102	7564702-R.....	118	A3 PE1.....	23	A7 HE3-R.....	39
7094704.....	101	7564703.....	118	A3 PE2.....	23	A7 KE1-R.....	39
7094704-R.....	101	7564703-R.....	118	A3 PE3.....	23	A7 KE2-R.....	39
7094804-R.....	36	7603501.....	119	A4 BL1.....	24	A7 KE3-R.....	39
7094805.....	36	7791501.....	132	A4 BL2.....	24	A7 KE 180-R.....	39
7094805-R.....	36	7791502-R.....	132	A4 BL3.....	24	A7 PE1-R.....	39
7094904.....	28	70941204-R.....	40	A4 BL 180.....	24	A7 PE2-R.....	39
7094905.....	28	70941205-R.....	40	A4 HE1.....	24	A7 PE3-R.....	39
7094905-R.....	28	70950305.....	114	A4 HE2.....	24	A7 RST 1-R.....	38
7095004.....	35	A1 HE1.....	6	A4 HE3.....	24	A7 RST 2-R.....	38
7095005-R.....	35	A1 HE2.....	6	A4 KE1.....	24	A8 HE1-R.....	40
7095015.....	35	A1 HE3.....	6	A4 KE2.....	24	A8 HE2-R.....	40
7095105-R.....	38	A1 KE1.....	6	A4 KE3.....	24	A8 HE3-R.....	40
7095305.....	25	A1 KE2.....	6	A4 NG1-R.....	26	A8 RST 1-R.....	40
7095305-R.....	26	A1 KE3.....	6	A4 NG2-R.....	26	A8 RST 2-R.....	40
7095501.....	116	A1 M1.....	7	A4 NG3-R.....	26	A 30.....	192
7095501-R.....	116	A1 M2.....	7	A4 NG 90-R.....	26	A 45.....	193
7095503.....	116	A1 M3.....	7	A4 NG 180-R.....	26	A 60.....	193
7095503-R.....	116	A1 M 90.....	7	A4 PE1.....	24	A 80.....	194
7095554.....	115	A1 M 180.....	7	A4 PE2.....	24	A 100.....	195
7095554-R.....	115	A1 NG 90-R.....	7	A4 PE3.....	24	A 125.....	196
7096004.....	120	A1 NG 180-R.....	7	A4 RST 1.....	25	A 150.....	197
7131402.....	53	A1 PE1.....	6	A4 RST 2.....	25	ABS45 80.....	173
7132002.....	54	A1 PE2.....	6	A5 HE1.....	30	ABS45 100.....	181
7291401.....	98	A1 PE3.....	6	A5 HE2.....	30	ABS 80.....	194
7291401-R.....	99	A2 BL1.....	8	A5 HE3.....	30	ABS 100.....	195
7291402-R.....	99	A2 BL2.....	8	A5 KE1.....	30	ABS 125.....	196
7291403-R.....	99	A2 BL3.....	8	A5 KE2.....	30	ACBL 80.....	194
7291406-R.....	99	A2 HE1.....	8	A5 KE3.....	30	ACBL 100.....	195
7300000.....	154	A2 HE2.....	8	A5 KR 90.....	30	ACBL 125.....	196
7300002.....	154	A2 HE3.....	8	A5 KR 180.....	30	ACH-150.....	267
7300135.....	148	A2 KE1.....	8	A5 KR 270.....	30	ACH-200.....	267
7301135.....	151	A2 KE2.....	8	A5 NG1-R.....	29	ACH-250.....	267
7303031-BL.....	151	A2 KE3.....	8	A5 NG2-R.....	29	ACH-300.....	267
7303031-W.....	151	A2 KE 270.....	8	A5 NG3-R.....	29	ACH-350.....	267

# HAKEMISTO

## FÖRTECKNING

### INDEX

TUOTENRO PRODUKTNR PRODUCT NO	SIVU SIDA PAGE	TUOTENRO PRODUKTNR PRODUCT NO	SIVU SIDA PAGE	TUOTENRO PRODUKTNR PRODUCT NO	SIVU SIDA PAGE	TUOTENRO PRODUKTNR PRODUCT NO	SIVU SIDA PAGE
ACH-400	267	AW 125	196	B2 KE3	20	B3 ANO2	66
ACH-450	267	AWSR 80	194	B2 KG1	16	B3 ANO3	66
ACH-500	267	AWSR 100	195	B2 KG2	16	B3 BL1	70
ACH-600	267	AWSR 125	196	B2 KG3	16	B3 BL2	70
ACH-800	267	B1 CW1	11	B2 KO1	16	B3 BL3	70
ACH-1520	267	B1 CW2	11	B2 KO2	16	B3 CBL1	70
ACH-2025	267	B1 CW3	11	B2 KO3	16	B3 CBL2	70
ACH-2030	267	B1 HE1	13	B2 LA1	17	B3 CBL3	70
ACH-2530	267	B1 HE2	13	B2 LA2	17	B3 CW1	66
ACH-3040	267	B1 HE3	13	B2 LA3	17	B3 CW2	66
ACH-3050	267	B1 KE1	13	B2 LO1	17	B3 CW3	66
ACH-3060	267	B1 KE2	13	B2 LO2	17	B3 GRO1	66
ACH-4050	267	B1 KE3	13	B2 LO3	17	B3 GRO2	66
ACH-4060	267	B1 LO1	11	B2 MO1	17	B3 GRO3	66
ACH-5060	267	B1 LO2	11	B2 MO2	17	B3 HE1	65
ACH-6080	267	B1 LO3	11	B2 MO3	17	B3 HE2	65
ACP-150	269	B1 M1	10	B2 NG1	14	B3 HE3	65
ACP-200	269	B1 M2	10	B2 NG2	14	B3 KE1	65
ACP-300	269	B1 M3	10	B2 NG3	14	B3 KE2	65
ACP-400	269	B1 MO1	11	B2 NOA1	17	B3 KE3	65
ACP-500	269	B1 MO2	11	B2 NOA2	17	B3 KG1	66
ACP-600	269	B1 MO3	11	B2 NOA3	17	B3 KG2	66
ACT-200	271	B1 NG1	13	B2 NSO1	17	B3 KG3	66
ACT-300	271	B1 NG2	13	B2 NSO2	17	B3 KO1	66
ACT-400	271	B1 NG3	13	B2 NSO3	17	B3 KO2	66
ACT-500	271	B1 NOA1	11	B2 PE1	20	B3 KO3	66
ACT-600	271	B1 NOA2	11	B2 PE2	20	B3 LA1	67
AE 20	192	B1 NOA3	11	B2 PE3	20	B3 LA2	67
AE 45	193	B1 PE1	13	B2 PH1	18	B3 LA3	67
AE 60	193	B1 PE2	13	B2 PH2	18	B3 LO1	67
AE 80	194	B1 PE3	13	B2 PH3	18	B3 LO2	67
AE 100	195	B1 PY 90	11	B2 PY1	18	B3 LO3	67
AE 125	196	B1 PY 180	11	B2 PY2	18	B3 MO1	67
AE 150	197	B1 PY 270	11	B2 PY3	18	B3 MO2	67
AGRR 80	194	B1 RST 1	10	B2 PY 270	18	B3 MO3	67
AGRR 100	195	B1 RST 2	10	B2 ROA1	18	B3 NG1	70
AGRR 125	196	B1 RST 3	10	B2 ROA2	18	B3 NG2	70
AK 38 STOP	104	B1 TA1	12	B2 ROA3	18	B3 NG3	70
AK 38-103	104	B1 TA2	12	B2 RST 1	21	B3 NOA1	67
AK 38-412	104	B1 TA3	12	B2 RST 2	21	B3 NOA2	67
AK 38-414	104	B2 ANO1	16	B2 RST 3	21	B3 NOA3	67
AK 38-418	104	B2 ANO2	16	B2 TA1	18	B3 NSO1	67
AK 38-420	104	B2 ANO3	16	B2 TA2	18	B3 NSO2	67
AK 38-422	104	B2 BL1	14	B2 TA3	18	B3 NSO3	67
AK 38-470	104	B2 BL2	14	B2 WE1	18	B3 PE1	65
AK 55-412	117	B2 BL3	14	B2 WE2	18	B3 PE2	65
AK 55-470	117	B2 CBL1	14	B2 WE3	18	B3 PE3	65
AMUR 80	194	B2 CBL2	14	B2 WH1	14	B3 PH1	68
AMUR 100	195	B2 CBL3	14	B2 WH2	14	B3 PH2	68
AMUR 125	196	B2 CW1	16	B2 WH3	14	B3 PH3	68
ANG 80	194	B2 CW2	16	B2S HE1	15	B3 PY1	68
ANG 100	195	B2 CW3	16	B2S HE2	15	B3 PY2	68
ANG 125	196	B2 GRO1	16	B2S HE3	15	B3 PY3	68
ASAR 80	194	B2 GRO2	16	B2S KE1	15	B3 PY 270	68
ASAR 100	195	B2 GRO3	16	B2S KE2	15	B3 ROA1	68
ASAR 125	196	B2 HE1	20	B2S KE3	15	B3 ROA2	68
ASI45 80	173	B2 HE2	20	B2S PE1	15	B3 ROA3	68
ASI45 100	181	B2 HE3	20	B2S PE2	15	B3 ROA 270	68
AW 80	194	B2 KE1	20	B2S PE3	15	B3 RST 1	70
AW 100	195	B2 KE2	20	B3 ANO1	66	B3 RST 2	70

# HAKEMISTO FÖRTECKNING INDEX

TUOTENRO PRODUKTNR PRODUCT NO	SIVU SIDA PAGE	TUOTENRO PRODUKTNR PRODUCT NO	SIVU SIDA PAGE	TUOTENRO PRODUKTNR PRODUCT NO	SIVU SIDA PAGE	TUOTENRO PRODUKTNR PRODUCT NO	SIVU SIDA PAGE
B3 RST 3	70	B10 NG2	75	C1 PE 90	58	C7 HE3	73
B3 TA1	68	B10 NG3	75	C1 PE 180	58	C7 HE 90	73
B3 TA2	68	B10 NOA1	76	C1 PE 270	58	C7 KE1	73
B3 TA3	68	B10 NOA2	76	C2 HE1	60	C7 KE2	73
B3 WE1	69	B10 NOA3	76	C2 HE2	60	C7 KE3	73
B3 WE2	69	B10 TA1	77	C2 HE3	60	C7 KE 90	73
B3 WE3	69	B10 TA2	77	C2 KE1	60	C7 KE 180	73
B3 WH1	70	B10 TA3	77	C2 KE2	60	C7 KE 270	73
B3 WH2	70	B10 TA 90	77	C2 KE3	60	C7 NG1	74
B3 WH3	70	B10 TA 180	77	C2 PE1	60	C7 NG2	74
B3S HE1	71	B10 TA 270	77	C2 PE2	60	C7 NG3	74
B3S HE2	71	B10 WH1	75	C2 PE3	60	C8 HE2	131
B3S HE3	71	B10 WH2	75	C3 HE1	72	C8 PE1	131
B3S KE1	71	B10 WH3	75	C3 HE2	72	C8 PE2	131
B3S KE2	71	B20 NG3	148	C3 HE3	72	C9 NG1-R	79
B3S KE3	71	B20 RST 3	148	C3 KE1	72	C9 NG2-R	79
B3S PE1	71	B60 CBL1	34	C3 KE2	72	C9 NG3-R	79
B3S PE2	71	B60 CBL2	34	C3 KE3	72	C9S HE1	78
B3S PE3	71	B60 CBL3	34	C3 PE1	72	C9S HE2	78
B7 RST 1	97	B60 CW1	32	C3 PE2	72	C9S HE3	78
B7 RST 2	97	B60 CW2	32	C3 PE3	72	C9S KE1	78
B7 RST 3	97	B60 CW3	32	C4 BL1	61	C9S KE2	78
B8 CBL3	151	B60 HE1	34	C4 BL2	61	C9S KE3	78
B8 CW 90	152	B60 HE2	34	C4 BL3	61	C9S KR1	78
B8 CW 180	152	B60 HE3	34	C4 BL 180	61	C9S KR2	78
B8 CW 270	152	B60 LO1	32	C4 HE1	61	C9S KR3	78
B8 NG3	151	B60 LO2	32	C4 HE2	61	C9S KR 180	78
B8 RST 1	151	B60 LO3	32	C4 HE3	61	C9S PE1	78
B8 RST 3	151	B60 MO1	32	C4 KE1	61	C9S PE2	78
B8 RST 150	151	B60 MO2	32	C4 KE2	61	C9S PE3	78
B8 RST BL3	151	B60 MO3	32	C4 KE3	61	C10 M1	208
B8 RST CU3	151	B60 NG1	34	C4 KR1	61	C10 M2	208
B8 TA1	152	B60 NG2	34	C4 KR2	61	C10 M3	208
B8 TA2	152	B60 NG3	34	C4 KR3	61	C4S KE 270	59
B8 TA3	152	B60 NOA1	32	C4 KR 180	61	CBL-6541	172
B9 NG3	155	B60 NOA2	32	C4 M1	63	CBL-6551	180
B9 RST 1	155	B60 NOA3	32	C4 M2	63	CBL-6561	187
B9 RST 3	155	B60 ROA1	32	C4 M3	63	CBS-6541	172
B9 RST 150	155	B60 ROA2	32	C4 M 90	63	CBS-6551	180
B10 CBL1	75	B60 ROA3	32	C4 PE1	62	CBS-6561	187
B10 CBL2	75	B60 TA1	33	C4 PE2	62	CCBL-6541	172
B10 CBL3	75	B60 TA2	33	C4 PE3	62	CCBL-6551	180
B10 CW1	76	B60 TA3	33	C4S HE1	63	CCBL-6561	187
B10 CW2	76	B60 WH1	34	C4S HE2	63	CD 2314-AS	230
B10 CW3	76	B60 WH2	34	C4S HE3	63	CGRR-6541	172
B10 CW 270	76	B60 WH3	34	C4S HE 90	63	CGRR-6551	180
B10 HE1	75	BRW150	223	C4S KE1	63	CGRR-6561	187
B10 HE2	75	C1 HE1	58	C4S KE2	63	CHE-6541	172
B10 HE3	75	C1 HE2	58	C4S KE3	63	CHE-6551	180
B10 KE1	75	C1 HE3	58	C4S KE 180	63	CHE-6561	187
B10 KE2	75	C1 HE 90	58	C4S PE1	64	CHF3-200	285
B10 KE3	75	C1 HE 180	58	C4S PE2	64	CHF3-300	285
B10 LO1	76	C1 KE1	58	C4S PE3	64	CHF3-400	285
B10 LO2	76	C1 KE2	58	C4S PE 90	64	CHF3-500	285
B10 LO3	76	C1 KE3	58	C4S PE 180	64	CHF3-600	285
B10 LO 270	76	C1 KE 180	58	C5 PE1	131	CMUR-6541	172
B10 MO1	76	C1 KE 270	58	C5 PE2	131	CMUR-6551	180
B10 MO2	76	C1 PE1	58	C6 PE2	131	CMUR-6561	187
B10 MO3	76	C1 PE2	58	C7 HE1	73	CNG-6541	172
B10 NG1	75	C1 PE3	58	C7 HE2	73	CNG-6551	180

# HAKEMISTO

## FÖRTECKNING

### INDEX

TUOTENRO PRODUKTNR PRODUCT NO	SIVU SIDA PAGE	TUOTENRO PRODUKTNR PRODUCT NO	SIVU SIDA PAGE	TUOTENRO PRODUKTNR PRODUCT NO	SIVU SIDA PAGE	TUOTENRO PRODUKTNR PRODUCT NO	SIVU SIDA PAGE
CNG-6561.....	187	D4 KE2.....	98	D9 KE2.....	106	E6 KO 90.....	83
CSAR-6541.....	172	D4 KE3.....	98	D9 KE3.....	106	E6 KO 180.....	83
CSAR-6551.....	180	D4 NG1-R.....	99	D9 KE 90.....	106	E6 KO 270.....	83
CSAR-6561.....	188	D4 NG2-R.....	99	D9 KE 180.....	106	E6 LA1.....	83
CT-6541.....	172	D4 NG3-R.....	99	D9 NG1-R.....	107	E6 LA2.....	83
CT-6551.....	180	D4 PE1.....	98	D9 NG2-R.....	107	E6 LA3.....	83
CT-6561.....	188	D4 PE2.....	98	D9 NG3-R.....	107	E6 LO1.....	83
CW-6541.....	172	D4 PE3.....	98	D9 NG 90-R.....	107	E6 LO2.....	83
CW-6551.....	180	D5 A1.....	88	D9 PE1.....	106	E6 LO3.....	83
CW-6561.....	188	D5 A2.....	88	D9 PE2.....	106	E6 MO1.....	84
CWSR-6541.....	172	D5 A3.....	88	D9 PE3.....	106	E6 MO2.....	84
CWSR-6551.....	180	D5 A 90.....	88	D9 PE 90.....	106	E6 MO3.....	84
CWSR-6561.....	188	D5 M1.....	88	D10 JVA1.....	105	E6 NG1.....	82
D1 HE1.....	89	D5 M2.....	88	D10 JVA2.....	105	E6 NG2.....	82
D1 HE2.....	89	D5 M3.....	88	D10 TLA1.....	105	E6 NG3.....	82
D1 HE3.....	89	D5 M 90.....	88	D10 TLA2.....	105	E6 NOA 1.....	84
D1 KE1.....	89	D7 KE1.....	111	D11 JVA1.....	96	E6 NOA 2.....	84
D1 KE2.....	89	D7 KE2.....	111	D11 JVA2.....	96	E6 NOA 3.....	84
D1 KE3.....	89	D7 KE3.....	111	DIV5 HE1.....	109	E6 PE 90.....	82
D1 PE1.....	89	D7 KR1.....	111	DIV5 HE2.....	109	E6 PE 180.....	82
D1 PE2.....	89	D7 KR2.....	111	DIV5 HE3.....	109	E6 PE 270.....	82
D1 PE3.....	89	D7 KR3.....	111	DIV5 NG1.....	109	E6 PH 90.....	84
D2 HE1.....	90	D7 KR 90.....	111	DIV5 NG2.....	109	E6 PH 180.....	84
D2 HE2.....	90	D7 NG1-R.....	113	DIV5 NG3.....	109	E6 PH 270.....	84
D2 KE1.....	90	D7 NG2-R.....	113	DV5 HE1.....	108	E6 PY 90.....	84
D2 KE2.....	90	D7 NG3-R.....	113	DV5 HE2.....	108	E6 PY 180.....	84
D2 KE3.....	90	D7 PE1.....	111	DV5 HE3.....	108	E6 PY 270.....	84
D2 KE 90.....	90	D7 PE2.....	111	DV5 NG1.....	108	E6 ROA1.....	84
D2 M1.....	90	D7 PE3.....	111	DV5 NG2.....	108	E6 ROA2.....	84
D2 M2.....	91	D7 RST3.....	112	DV5 NG3.....	108	E6 ROA3.....	84
D2 M3.....	91	D8 HE1.....	100	E5 HE 90.....	44	E6 TA1.....	85
D2 M 90.....	90	D8 HE1-R.....	102	E5 HE 180.....	44	E6 TA2.....	85
D2 PE1.....	91	D8 HE2.....	100	E5 HE 270.....	44	E6 TA3.....	85
D2 PE2.....	91	D8 HE2-R.....	102	E5 KE 90.....	44	E6 TA 90.....	85
D3 BL1.....	92	D8 HE3.....	100	E5 KE 180.....	44	E8 ANO1.....	51
D3 BL2.....	92	D8 HE3-R.....	102	E5 KE 270.....	44	E8 ANO2.....	51
D3 BL3.....	92	D8 HE 90.....	100	E5 NG 93.....	45	E8 ANO3.....	51
D3 HE1.....	92	D8 HE 90-R.....	102	E5 NG 183.....	45	E8 CW1.....	51
D3 HE2.....	92	D8 HE 180.....	100	E5 NG 282.....	45	E8 CW2.....	51
D3 HE3.....	92	D8 KE1.....	100	E5 PE 90.....	44	E8 CW3.....	51
D3 KE1.....	92	D8 KE2.....	100	E5 PE 180.....	44	E8 HE1.....	50
D3 KE2.....	92	D8 KE3.....	100	E5 PE 270.....	44	E8 HE2.....	50
D3 KE3.....	92	D8 KE 90.....	100	E5 PH 90.....	45	E8 HE3.....	50
D3 KR1.....	92	D8 KE 180.....	100	E5 PH 180.....	45	E8 LA1.....	51
D3 KR2.....	92	D8 NG1-R.....	102	E5 PH 270.....	45	E8 LA2.....	51
D3 KR3.....	92	D8 NG2-R.....	102	E5 TA 90.....	45	E8 LA3.....	51
D3 NG1-R.....	93	D8 NG3-R.....	102	E5 TA 180.....	45	E8 LO1.....	51
D3 NG2-R.....	93	D8 PE1.....	100	E5 TA 270.....	45	E8 LO2.....	51
D3 PE1.....	92	D8 PE2.....	100	E6 ANO1.....	83	E8 LO3.....	51
D3 PE2.....	92	D8 PE3.....	100	E6 ANO2.....	83	E8 LO 282.....	51
D3 PE3.....	92	D8 PE 90.....	100	E6 ANO3.....	83	E8 MO1.....	52
D3 RST3.....	93	D9 HE1.....	106	E6 CW1.....	83	E8 MO2.....	52
D4 BL1.....	98	D9 HE1-R.....	107	E6 CW2.....	83	E8 MO3.....	52
D4 BL2.....	98	D9 HE2.....	106	E6 CW3.....	83	E8 NG1.....	50
D4 BL3.....	98	D9 HE2-R.....	107	E6 HE 90.....	82	E8 NG2.....	50
D4 BL 90.....	98	D9 HE3.....	106	E6 HE 180.....	82	E8 NG3.....	50
D4 HE1.....	98	D9 HE3-R.....	107	E6 HE 270.....	82	E8 NOA1.....	52
D4 HE2.....	98	D9 HE 90.....	106	E6 KE 90.....	82	E8 NOA2.....	52
D4 HE3.....	98	D9 HE 90-R.....	107	E6 KE 180.....	82	E8 NOA3.....	52
D4 KE1.....	98	D9 KE1.....	106	E6 KE 270.....	82	E8 ROA1*.....	52

# HAKEMISTO FÖRTECKNING INDEX

TUOTENRO PRODUKTNR PRODUCT NO	SIVU SIDA PAGE	TUOTENRO PRODUKTNR PRODUCT NO	SIVU SIDA PAGE	TUOTENRO PRODUKTNR PRODUCT NO	SIVU SIDA PAGE	TUOTENRO PRODUKTNR PRODUCT NO	SIVU SIDA PAGE
E8 ROA2*	52	E34L NSO 1	42	E 30	192	I1 CBL2	232
E8 ROA3*	52	E34L NSO 2	42	E 45	193	I1 CBL3	232
E8 STA1	50	E34L NSO 3	42	E 60	193	I1 HE1	232
E8 STA2	50	E34L OAK 1	42	E 80	194	I1 HE2	232
E8 STA3	50	E34L OAK 2	42	E 100	195	I1 HE3	232
E8 TA1	52	E34L OAK 3	42	E 125	196	I1 W1	232
E8 TA2	52	E34L SAND 1	43	E 150	197	I1 W2	232
E8 TA3	52	E34L SAND 2	43	EC-40 AS L	136	I2 CBL1	233
E8 WH 282	50	E34L SAND 3	43	EC-40 AS R	136	I2 CBL2	233
E24L CW2	124	E34L SI 1	43	EC-40 NG L	137	I2 CBL3	233
E24L CW 3	124	E34L SI 2	43	EC-40 NG R	137	I2 HE1	233
E24L LA2	124	E34L SI 3	43	EC-40 SI L	138	I2 HE2	233
E24L LA 1	124	E34L STA 1	43	EC-40 SI R	138	I2 HE3	233
E24L LA 3	124	E34L STA 2	43	EC-60 AS L	139	I2 W1	233
E24L LO2	125	E34L STA 3	43	EC-60 AS R	139	I2 W2	233
E24L LO 1	125	E34L TA 1	42	EC-60 NG L	140	I3 CBL1	234
E24L LO 3	125	E34L TA 2	42	EC-60 NG R	140	I3 CBL2	234
E24L NOA 1	125	E34L TA 3	42	EC-60 SI L	141	I3 CBL3	234
E24L NOA 2	125	E35 ANO1	128	EC-60 SI R	141	I3 HE1	234
E24L NOA 3	125	E35 ANO2	128	FR30-200	275	I3 HE2	234
E24L OAK 1	125	E35 ANO3	128	FR30-300	275	I3 HE3	234
E24L OAK 2	125	E35 CBL1	127	FR30-400	275	I3 W1	234
E24L OAK 3	125	E35 CBL2	127	FR30-500	275	I3 W2	234
E24L SAND 1	126	E35 CBL3	127	FR30-600	275	IC-40 AS	136
E24L SAND 2	126	E35 HE1	127	FR60-200	277	IC-40 NG	137
E24L SAND 3	126	E35 HE2	127	FR60-300	277	IC-40 SI	138
E24L SI 1	126	E35 HE3	127	FR60-400	277	IC-60 AS	139
E24L SI 2	126	E35 NG1	127	FR60-500	277	IC-60 NG	140
E24L SI 3	126	E35 NG2	127	FR60-600	277	IC-60 SI	141
E24L STA 1	126	E35 NG3	127	H1 HE1	249	ICBL-6534	168
E24L STA 2	126	E35 NOA1	128	H1 HE2	249	ICBL-6535	176
E24L STA 3	126	E35 NOA2	128	H1 W1	249	ICBL-6570	184
E24L TA2	125	E35 NOA3	128	H1 W2	249	ICBS-6534	168
E24L TA 1	125	E35 TA1	128	H2 HE1	249	ICBS-6535	176
E24L TA 3	125	E35 TA2	128	H2 HE2	249	ICBS-6570	184
E34L ANO 1	41	E35 TA3	128	H2 W1	249	ICCBL-6534	168
E34L ANO 2	41	E38L CW 3	81	H2 W2	249	ICCBL-6535	176
E34L ANO 3	41	E38L LA 3	81	HL 1016-410	221	ICCBL-6570	184
E34L CW 1	41	E38L LO 3	81	HSA-200	281	ICGRR-6534	168
E34L CW 2	41	E38L NOA 3	81	HSA-300	281	ICGRR-6535	176
E34L CW 3	41	E38L OAK 1	81	HSA-400	281	ICGRR-6570	184
E34L GRO 1	41	E38L OAK 2	81	HSA-500	281	ICMUR-6534	168
E34L GRO 2	41	E38L OAK 3	81	HSA-600	281	ICMUR-6535	176
E34L GRO 3	41	E38L SAND 1	80	HSF3-300	283	ICMUR-6570	184
E34L KG 1	41	E38L SAND 2	80	HSF3-400	283	ICNG-6534	168
E34L KG 2	41	E38L SAND 3	80	HSF3-500	283	ICNG-6535	176
E34L KG 3	41	E38L SI 1	80	HSF3-600	283	ICNG-6570	184
E34L LA 1	41	E38L SI 2	80	HSF3-6010	283	ICS-6534	168
E34L LA 2	41	E38L SI 3	80	HSF3-6080	283	ICS-6535	176
E34L LA 3	41	E38L STA 1	80	HSL21-200	279	ICS-6570	184
E34L LO 1	42	E38L STA 2	80	HSL21-300	279	ICSAR-6534	168
E34L LO 2	42	E38L STA 3	80	HSL21-400	279	ICSAR-6535	176
E34L LO 3	42	E38L TA 3	81	HSL21-500	279	ICSAR-6570	184
E34L NG 1	43	E71 CW 270	130	HSL21-600	279	ICT-6534	168
E34L NG 2	43	E71 LO 270	130	HSL-200	279	ICT-6535	176
E34L NG 3	43	E71 NG 270	130	HSL-300	279	ICT-6570	184
E34L NOA 1	42	E71 SI 270	130	HSL-400	279	ICW-6534	168
E34L NOA 2	42	E71 TA 270	130	HSL-500	279	ICW-6535	176
E34L NOA 3	42	E71 WH 270	130	HSL-600	279	ICW-6570	184
		E 20-10	201	I1 CBL1	232	ICWSR-6534	168

# HAKEMISTO

## FÖRTECKNING

### INDEX

TUOTENRO PRODUKTNR PRODUCT NO	SIVU SIDA PAGE	TUOTENRO PRODUKTNR PRODUCT NO	SIVU SIDA PAGE	TUOTENRO PRODUKTNR PRODUCT NO	SIVU SIDA PAGE	TUOTENRO PRODUKTNR PRODUCT NO	SIVU SIDA PAGE
ICWSR-6535	176	JL 70-410	144	K1 MO1	48	L3 HE2	238
ICWSR-6570	184	JL 70-412	144	K1 MO2	48	L3 HE3	238
ISH-200	273	JL 70-470	144	K1 MO3	48	L3 NG1	238
ISH-300	273	JL 100-410	144	K1 NG1	46	L3 NG2	238
ISH-400	273	JL 100-412	144	K1 NG2	46	L3 RST1	239
ISH-500	273	JL 100-470	144	K1 NG3	46	L3 RST2	239
ISH-600	273	JL AS 40	136	K1 NG 90	46	L3 RST3	239
J1 CBL1	254	JL AS 60	139	K1 NG 180	46	L3 W1	238
J1 CBL2	254	JL NG 40	137	K1 NOA1	48	L3 W2	238
J1 CBL3	254	JL NG 60	140	K1 NOA2	48	L3 W3	238
J1 HE1	254	JL SI 40	138	K1 NOA3	48	L3T BL3	239
J1 HE2	254	JL SI 60	141	K1 PH 90	48	L3T NG3	239
J1 W1	254	JLMS 200	146	K1 PH 180	48	L4 BL1	240
J1 W2	254	JLMS 300	146	K1 PH 270	48	L4 BL2	240
JK 88-410	226	JLP 40-410	145	K1 PY1	48	L4 CBL1	240
JK 128-410	226	JLP 40-411	145	K1 PY2	48	L4 CBL2	240
JK 1616-410	227	JLP 40-412	145	K1 PY3	48	L4 CBL3	240
JK 1616-CP	227	JLP 40-418	145	K1 PY 90	48	L4 HE1	240
JK 1616-EC	227	JLP 40-470	145	K1 PY 180	48	L4 HE2	240
JK 1616-FT	227	JLP 60-410	145	K1 ROA1*	49	L4 HE3	240
JK 1616-TA	227	JLP 60-411	145	K1 ROA2*	49	L4 NG1	240
JK 2516-410	228	JLP 60-412	145	K1 ROA3*	49	L4 NG2	240
JK 2516-CP	228	JLP 60-418	145	K1 TA1	49	L4 RST1	241
JK 2516-EA	228	JLP 60-470	145	K1 TA2	49	L4 RST2	241
JK 2516-EC	228	JLRST 40 HI 0,8	134	K1 TA3	49	L4 RST3	241
JK 2516-FT	228	JLRST 40-JOHTO	134	K1 WE1	49	L4 W1	240
JK 2516-TA	228	JLRST 60 HI 0,8	135	K1 WE2	49	L4 W2	240
JK 2525-410	229	JLRST 100 HI 0,8	135	K1 WE3	49	L4 W3	240
JK 4016-410	229	JLRST 200	146	K2 OA 270	49	L4T BL3	241
JK 4016-TA	229	JLRST 300	146	KEYPL	287	L4T NG3	241
JK 4030-410	230	JLT 35	144	KL 21-470	146	L5 BL1	243
JK 6040-410	230	JLT 55	144	KY 70-412	209	L5 BL2	243
JL40EC RST	134	JP-40 AS	136	KY 95-412	209	L5 CBL1	243
JL40IC RST	134	JP-40 NG	137	L1 CBL1	236	L5 CBL2	243
JL60EC RST	135	JP-40 SI	138	L1 CBL2	236	L5 CBL3	243
JL60IC RST	135	JP-60 AS	139	L1 CBL3	236	L5 HE1	243
JL 40-103	142	JP-60 NG	140	L1 HE1	236	L5 HE2	243
JL 40-410	142	JP-60 SI	141	L1 HE2	236	L5 HE3	243
JL 40-411	142	K1 CW1	47	L1 HE3	236	L5 NG1	243
JL 40-412	142	K1 CW2	47	L1 W1	236	L5 NG2	243
JL 40-414	142	K1 CW3	47	L1 W2	236	L5 RST1	244
JL 40-418	142	K1 HE1	46	L1 W3	236	L5 RST2	244
JL 40-420	142	K1 HE2	46	L2 CBL1	237	L5 RST3	244
JL 40-470	142	K1 HE3	46	L2 CBL2	237	L5 W1	243
JL 40T-410	142	K1 HE 90	46	L2 CBL3	237	L5 W2	243
JL 40T-412	142	K1 HE 180	46	L2 HE1	237	L5 W3	243
JL 40T-418	142	K1 KG1	47	L2 HE2	237	L5T BL3	244
JL 40T-470	142	K1 KG2	47	L2 HE3	237	L5T NG3	244
JL 60-103	143	K1 KG3	47	L2 RST1	237	L6 HE1	245
JL 60-410	143	K1 KO1	47	L2 RST2	237	L6 HE2	245
JL 60-411	143	K1 KO2	47	L2 RST3	237	L6 HE3	245
JL 60-412	143	K1 KO3	47	L2 W1	237	L6 RST1	245
JL 60-414	143	K1 KO 90	47	L2 W2	237	L6 RST2	245
JL 60-418	143	K1 LA1	47	L2 W3	237	L6 RST3	245
JL 60-420	143	K1 LA2	47	L3 BL1	238	L6 W1	245
JL 60-470	143	K1 LA3	47	L3 BL2	238	L6 W2	245
JL 60T-410	143	K1 LO1	47	L3 CBL1	238	L6 W3	245
JL 60T-412	143	K1 LO2	48	L3 CBL2	238	L7 HE1	242
JL 60T-418	143	K1 LO3	48	L3 CBL3	238	L7 HE2	242
JL 60T-470	143	K1 LO 180	47	L3 HE1	238	L7 HE3	242

# HAKEMISTO FÖRTECKNING INDEX

TUOTENRO PRODUKTNR PRODUCT NO	SIVU SIDA PAGE	TUOTENRO PRODUKTNR PRODUCT NO	SIVU SIDA PAGE	TUOTENRO PRODUKTNR PRODUCT NO	SIVU SIDA PAGE	TUOTENRO PRODUKTNR PRODUCT NO	SIVU SIDA PAGE
L7 W1	242	M92S RST	211	OCBS-6535	177	PL-400-R	286
L7 W2	242	M102S CBL	211	OCBS-6570	185	PL-500	286
L7 W3	242	M102S NG	211	OCCBL-6534	169	PL-500 MG	287
L10 CBL1	235	M102S RST	211	OCCBL-6535	177	PL-500-R	286
L10 CBL2	235	M 30	192	OCCBL-6570	185	PLG 60	198
L10 CBL3	235	M 45	193	OCGRR-6534	169	PLG 80	198
L10 HE1	235	M 60	193	OCGRR-6535	177	PLG 100	198
L10 HE2	235	M 80	194	OCGRR-6570	185	PLPS-300	287
L10 HE3	235	M 100	195	OCMUR-6534	169	PP-9M	217
L10 W1	235	M 125	196	OCMUR-6535	177	PP-9MT	217
L10 W2	235	M 150	197	OCMUR-6570	185	PP-10M	217
L10 W3	235	MG202	287	OCNG-6534	169	PP-10MT	217
L20 RST2	149	NU 12-410	156	OCNG-6535	177	PWH 60	198
L20 RST 3	149	NU 15-410	156	OCNG-6570	185	PWH 80	198
L25 RST2	150	NU 15-412	156	OCS-6534	169	PWH 100	198
L30 RST2	153	NU 15-470	156	OCS-6535	177	PY 10-410	220
L30 RST3	153	NU 15T-410	156	OCS-6570	185	RST-JOHTO O	134
L2020 KSL3	149	NU 20-410	157	OCSAR-6534	169	RST-JOHTO U	134
L2525 KSL3	150	NU 20-412	157	OCSAR-6535	177	RST-JOHTO V	134
L3030 KSL3	153	NU 20-470	157	OCSAR-6570	185	SL9 JVA1	213
L4040 KSL3	154	NU 20T-410	158	OCT-6534	169	SL9 JVA2	213
L5050 KSL2	155	NU 25-410	159	OCT-6535	177	SL9 TLA1	213
L5050 KSL3	155	NU 25-412	159	OCT-6570	185	SL9 TLA2	213
LL 14/10	221	NU 25-470	159	OCW-6534	169	SN 15-410	157
LS 30 AL GREY	203	NU 25T-410	159	OCW-6535	177	ST269 BL 40	256
LS 30 RST GREY	203	NU 30-410	159	OCW-6570	185	ST269 BL 100	256
LS 45 AL GREY	203	NU 30-470	159	OCWSR-6534	169	ST269 BL 200	256
LS 45 RST GREY	203	NU 30T-410	160	OCWSR-6535	177	ST269 BL 300	256
LS 60 AL GREY	203	NU 40-410	160	OCWSR-6570	185	ST269 SI 40	260
LS 60 RST GREY	203	NU 40-412	160	P1 HE1	253	ST269 SI 100	260
LS 80 AL GREY	204	NU 40-470	160	P1 HE2	253	ST269 SI 200	260
LS 80 RST GREY	204	NU 40T-410	161	P1 W1	253	ST269 SI 300	260
LS 100 AL GREY	204	NU 50-410	161	P1 W2	253	ST424 BL 40	258
LS 100 RST GREY	204	NU 60-410	161	P2 HE1	253	ST424 BL 100	258
LS 125 AL GREY	204	O1 HE1	251	P2 HE2	253	ST424 BL 200	258
LS 125 RST GREY	204	O1 HE2	251	P2 W1	253	ST424 BL 300	258
LS 150 AL GREY	205	O1 W1	251	P2 W2	253	ST424 SI 40	262
LS 150 RST GREY	205	O1 W2	251	P5 HE	132	ST424 SI 100	262
M7K CBL	210	O2 HE1	252	P5 KR	132	ST424 SI 200	262
M7K NG	210	O2 HE2	252	PL 4-02	254	ST424 SI 300	262
M7K RST	210	O2 W1	252	PL 4-W	254	SW50 BL	257,259
M9ES RST	211	O2 W2	252	PL 32/10	218	SW50 SI	261,263
M9S CBL	210	O3 HE1	252	PL 33/5	218	T1 HE1	250
M9S NG	210	O3 HE2	252	PL 42/10	218	T1 HE2	250
M9S RST	210	O3 W1	252	PL 42/10-470	218	T1 W1	250
M9U CBL	212	O3 W2	252	PL 58/10	219	T1 W2	250
M9U NG	212	O10 HE1	251	PL-90	286	T2 HE1	250
M9U RST	212	O10 HE2	251	PL-90 MG	287	T2 HE2	250
M10ES RST	211	O10 W1	251	PL-90-R	286	T2 W1	250
M10K CBL	210	O10 W2	251	PL-140	286	T2 W2	250
M10K NG	210	OC-40 AS	136	PL-140 MG	287	T8-10 BS	200
M10K RST	210	OC-40 NG	137	PL-140-R	286	T8-10 HE	200
M10S CBL	210	OC-40 SI	138	PL-200	286	T10-12 BS	200
M10S NG	210	OC-60 AS	139	PL-200 MG	287	T10-12 HE	200
M10S RST	210	OC-60 NG	140	PL-200-R	286	T18-410	53
M10U CBL	212	OC-60 SI	141	PL-300	286	TC 20-410	158
M10U NG	212	OCBL-6534	169	PL-300 MG	287	TC 30-410	160
M10U RST	212	OCBL-6535	177	PL-300-R	286	TD3 CW1	95
M92S CBL	211	OCBL-6570	185	PL-400	286	TD3 CW2	95
M92S NG	211	OCBS-6534	169	PL-400 MG	287	TD3 CW3	95

# HAKEMISTO

## FÖRTECKNING

### INDEX

TUOTENRO PRODUKTNR PRODUCT NO	SIVU SIDA PAGE	TUOTENRO PRODUKTNR PRODUCT NO	SIVU SIDA PAGE
TD3 CW 180.....	95	WO6 OAK 2.....	86
TD3 CW 270.....	95	WO7 OAK 1.....	214
TD3 HE1.....	94	WO7 OAK 2.....	214
TD3 HE2.....	94	WO8 OAK 1.....	214
TD3 HE3.....	94	WO8 OAK 2.....	214
TD3 LO1.....	95	WO9 OAK 1.....	215
TD3 LO2.....	95	WO9 OAK 2.....	215
TD3 LO3.....	95	WO9 WO 2.....	215
TD3 LO 270.....	95	WO10 OAK 1.....	215
TD3 MO1.....	95	WO10 OAK 2.....	215
TD3 MO2.....	95	WO10 WO 2.....	215
TD3 MO3.....	95	WO11 OAK 1.....	216
TD3 NG1.....	94	WO11 OAK 2.....	216
TD3 NG2.....	94	WO55 MDF.....	199
TD3 NG3.....	94	WO55 OAK.....	199
TD3 NOA1.....	95	WO105 MDF.....	199
TD3 NOA2.....	95	WO105 OAK.....	199
TD3 NOA3.....	95	WS100 MDF.....	222
TD3 TA1.....	96	WS100 MO.....	222
TD3 TA2.....	96	WS110 MDF.....	222
TD3 TA3.....	96	WS120 MDF.....	222
TK20.....	158	WS120 MO.....	222
U1 HE1.....	246	WS130 MDF.....	222
U1 HE2.....	246	WS140 MDF.....	222
U1 W1.....	246	WS140 MO.....	222
U1 W2.....	246	WS150 MDF.....	222
U2 HE1.....	246	WS160 MDF.....	222
U2 HE2.....	246	WS160 MO.....	222
U2 W1.....	246	WS180 MDF.....	222
U2 W2.....	246	WS180 MO.....	222
U4 HE1.....	247	WSG100 MDF.....	223
U4 HE2.....	247	WSG110 MDF.....	223
U4 W1.....	247	WSG120 MDF.....	223
U4 W2.....	247	WSG130 MDF.....	223
U5 HE1.....	247	WSG140 MDF.....	223
U5 HE2.....	247	WSG150 MDF.....	223
U5 W1.....	247	WSG160 MDF.....	223
U5 W2.....	247	WSG180 MDF.....	223
U6 HE1.....	248	WT60 ASH 2.....	56
U6 HE2.....	248	WT60 MA 2.....	56
U6 W1.....	248	WT60 MO 2.....	56
U6 W2.....	248	WT60 MON 2.....	56
VAR 15-410.....	221	WT60 OAK 2.....	56
VL 20-412.....	206	WT60 WN 2.....	56
VL 20-414.....	206	ZW E269.....	257,261
VL 20-418.....	206	ZW E424.....	259,263
VL 20-470.....	206		
VLS 7.....	220		
VLS 16.....	220		
WO3 OAK 1.....	55		
WO3 OAK 2.....	55		
WO3 WO 1.....	55		
WO3 WO 2.....	55		
WO4 OAK 1.....	56		
WO4 OAK 2.....	56		
WO4 WO 1.....	56		
WO4 WO 2.....	56		
WO5 OAK 1.....	86		
WO5 OAK 2.....	86		
WO6 OAK 1.....	86		





#### FINLAND

DUURI OY  
 Tapulikaupungintie 35  
 FI-00750 Helsinki, Finland

p. 09 351 050 (myynti ja  
 tekninen neuvonta)  
 duuri@duuri.fi

#### DENMARK

D-PROFILE AB  
 Kabelvägen 10B  
 SE-55302 Jönköping, Sverige

Tel. +46 (0)36 – 18 63 63  
 info@d-profile.se

#### SWEDEN

D-PROFILE AB  
 Kabelvägen 10B  
 SE-55302 Jönköping, Sverige

Tel. +46 (0)36 – 18 63 63  
 info@d-profile.se

#### LATVIA, LITHUANIA AND ESTONIA

SIA D-PROFILE  
 Rigas iela 6  
 LV-2114 Olaine, Latvia

Tel. +371 6778 3506  
 Tel. +372 5058 880 (Estonia)  
 info@d-profile.lv

#### NORWAY

D-PROFILE AS  
 Glåmveien 3  
 NO-2500 Tynset, Norge

Tel. +46 (0)70 – 513 14 34  
 info@d-profile.se

[www.dione.fi](http://www.dione.fi)